

# 香港知識產權公報

Hong Kong Intellectual Property Journal

2024年3月1日

01 March 2024

## 目錄 Contents

### 根據註冊外觀設計條例第 25 條註冊的外觀設計

#### **Designs Registered under section 25 of the Registered Designs Ordinance**

按註冊編號排列

Arranged by Registration Number

### 根據註冊外觀設計條例(第 522 章)公布的其他公告

#### **Other Notices Published under the Registered Designs Ordinance (Cap. 522)**

根據註冊外觀設計條例第 28 條，註冊外觀設計因未繳續期費而停止有效

Registered designs ceased through non-payment of renewal fees under section 28 of the Registered Designs Ordinance

根據註冊外觀設計規則第 31 條刪除的註冊外觀設計

Registered designs removed under section 31 of the Registered Designs Rules

### 以下事項沒有記錄

#### **No Records for the Following Matters**

根據註冊外觀設計條例第 30 條放棄的外觀設計的註冊

Surrender of Registration of Design under section 30 of the Registered Designs Ordinance

根據註冊外觀設計規則第 37 條，向處長作出轉介

Reference to Registrar under section 37 of the Registered Designs Rules

根據註冊外觀設計條例第 45 條，撤銷註冊

Revocation of Registration under section 45 of the Registered Designs Ordinance

根據註冊外觀設計規則第 46 條，向法院作出轉介

Reference to Court under section 46 of the Registered Designs Rules

根據註冊外觀設計規則第 63 條對不符合規定之處作出糾正

Rectification of Irregularities under section 63 of the Registered Designs Rules

根據註冊外觀設計條例第 66 條，糾正註冊紀錄冊

Rectification of Register under section 66 of the Registered Designs Ordinance

根據註冊外觀設計條例第 67 條 更正註冊紀錄冊內的錯誤

Correction of errors in Register under section 67 of the Registered Designs Ordinance

根據註冊外觀設計條例第 67 及 76 條，更正註冊紀錄冊內及已提交文件中的錯誤

Correction of Errors in Register and in Filed Documents under sections 67 and 76 of the Registered Designs Ordinance

根據註冊外觀設計條例第 76 條，更正已提交文件中的錯誤

Correction of errors in filed documents under section 76 of the Registered Designs Ordinance

勘誤

Corrigendum

## 註冊外觀設計公告註釋

### Notes on advertisements of registration of designs

方括號表示下列資料：

Square brackets indicate the following data：

[11] 註冊編號 Registration number / 聯合王國註冊編號 United Kingdom registration number

[15] 註冊日期 Registration date / 當作註冊日期 Deemed registration date / 聯合王國註冊日期 United Kingdom registration date

[17] 註冊有效期屆滿日期 Expiry date of the period of registration

[22] 提交日期 Filing date / 當作提交日期 Deemed filing date / 聯合王國提交日期 United Kingdom filing date

[30] 聲稱享有的優先權（提交日期 / 巴黎公約國或世界貿易組織成員 / 申請編號） Priority claimed (filing date / Paris Convention country or WTO member / application number)

[51] 國際外觀設計分類號（洛迦諾分類號） International Classification of designs (Locarno Classification)

[54] 物品 Article

[55] 外觀設計的表述 Representation of the design

[62] 分開前的申請編號及提交日期 Application number before division and filing date

[66] 過往註冊的聯繫外觀設計註冊編號 / 日期 Registration No. / Date of Previous Registration for Association

[72] 設計人 Designer

[73] 擁有人姓名和地址 Name and address of the owner

[74] 代理人 Agent /送達地址 Address for service



香港特別行政區政府知識產權署外觀設計註冊處  
The Government of the Hong Kong Special Administrative Region  
Designs Registry, Intellectual Property Department

## 根據註冊外觀設計條例第 25 條註冊的外觀設計

### Designs registered under section 25 of the Registered Designs Ordinance

按註冊編號排列

Arranged by Registration Number

- [11] 2321736.3
- [15] 18-07-2023
- [30] 19-01-2023 / JP / 000827 of 2023
- [51] Cl. 21-02
- [54] 鍛煉用器具  
Training apparatus
- [73] 株式會社 MTG  
MTG CO., LTD.  
2-32 Honjin-tori, Nakamura-ku,  
Nagoya-shi, Aichi 4530041,  
Japan
- [74] CHINAHONGKONG IP LIMITED  
1502, 15/F, Capital Centre,  
151 Gloucester Road,  
Wanchai, Hong Kong

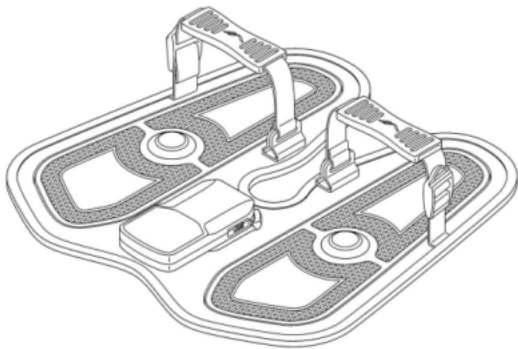

- 
- [11] 2321737.5
  - [15] 18-07-2023
  - [30] 19-01-2023 / JP / 000828 of 2023
  - [51] Cl. 21-02

[54] 鍛煉用器具

Training apparatus

[73] 株式會社 MTG

MTG CO., LTD.

2-32 Honjin-tori, Nakamura-ku,

Nagoya-shi, Aichi 4530041,

Japan

[74] CHINAHONGKONG IP LIMITED

1502, 15/F, Capital Centre,

151 Gloucester Road,

Wanchai, Hong Kong

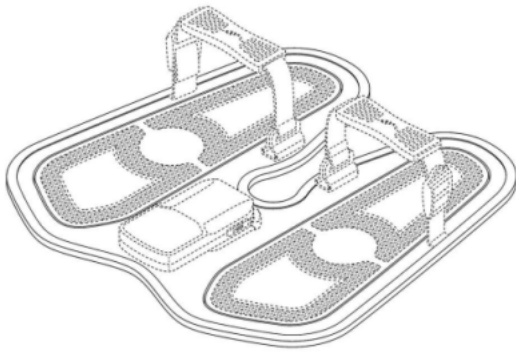

---

[11] 2322254.0M001

[15] 23-10-2023

[30] 28-09-2023 / NO, CH, TR, KR / WIPO139005

[51] Cl. 7-02

[54] 手動攪拌機

Hand mixer

[73] VERSUNI HOLDING B.V.

High Tech Campus 42,

5656AE Eindhoven,

Netherlands

[74] CHANG TSI AND PARTNERS INTELLECTUAL PROPERTY (HK) LIMITED

Level 20, One International Finance Centre,

No. 1 Harbour View Street, Central,

Hong Kong



---

[11] 2322254.0M002

[15] 23-10-2023

[30] 28-09-2023 / NO, CH, TR, KR / WIPO139005

[51] Cl. 7-01

[54] 燒杯

Beaker

[73] VERSUNI HOLDING B.V.

High Tech Campus 42,

5656AE Eindhoven,

Netherlands

[74] CHANG TSI AND PARTNERS INTELLECTUAL PROPERTY (HK) LIMITED

Level 20, One International Finance Centre,

No. 1 Harbour View Street, Central,

Hong Kong





- [11] 2322254.0M003  
[15] 23-10-2023  
[30] 28-09-2023 / NO, CH, TR, KR / WIPO139005  
[51] Cl. 7-99  
[54] 帶攪拌機配件的支架  
Stand with mixer accesories  
[73] VERSUNI HOLDING B.V.  
High Tech Campus 42,  
5656AE Eindhoven,  
Netherlands  
[74] CHANG TSI AND PARTNERS INTELLECTUAL PROPERTY (HK) LIMITED  
Level 20, One International Finance Centre,  
No. 1 Harbour View Street, Central,  
Hong Kong

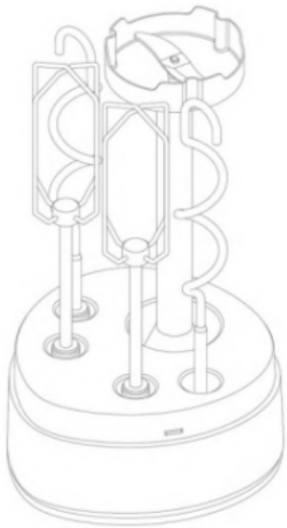

- 
- [11] 2322285.6M001  
[15] 31-10-2023  
[51] Cl. 12-16  
[54] 後視鏡  
Rearview mirror  
[73] Dr. Ing. h.c. F. Porsche Aktiengesellschaft  
Porscheplatz 1,  
70435 Stuttgart,  
Germany  
[74] WENPING PATENT & TRADE MARK AGENT LIMITED  
1701 Tung Wai Commercial Building,  
111 Gloucester Road,  
Hong Kong



---

[11] 2322285.6M002

[15] 31-10-2023

[51] Cl. 12-16

[54] 後視鏡

Rearview mirror

[73] Dr. Ing. h.c. F. Porsche Aktiengesellschaft

Porscheplatz 1,

70435 Stuttgart,

Germany

[74] WENPING PATENT & TRADE MARK AGENT LIMITED

1701 Tung Wai Commercial Building,

111 Gloucester Road,

Hong Kong



---

[11] 2322285.6M003

[15] 31-10-2023

[51] Cl. 12-16

[54] 汽車車身零件

Body part for vehicles

[73] Dr. Ing. h.c. F. Porsche Aktiengesellschaft  
Porscheplatz 1,  
70435 Stuttgart,  
Germany

[74] WENPING PATENT & TRADE MARK AGENT LIMITED  
1701 Tung Wai Commercial Building,  
111 Gloucester Road,  
Hong Kong



---

[11] 2322285.6M004

[15] 31-10-2023

[51] Cl. 12-16

[54] 汽車車身零件

Body part for vehicles

[73] Dr. Ing. h.c. F. Porsche Aktiengesellschaft  
Porscheplatz 1,  
70435 Stuttgart,  
Germany

[74] WENPING PATENT & TRADE MARK AGENT LIMITED  
1701 Tung Wai Commercial Building,  
111 Gloucester Road,  
Hong Kong

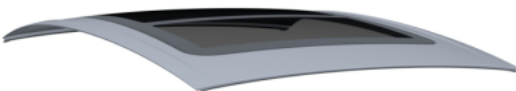

---

[11] 2322285.6M005

[15] 31-10-2023

[51] Cl. 12-16

[54] 汽車車身零件

Body part for vehicles

[73] Dr. Ing. h.c. F. Porsche Aktiengesellschaft  
Porscheplatz 1,  
70435 Stuttgart,  
Germany

[74] WENPING PATENT & TRADE MARK AGENT LIMITED  
1701 Tung Wai Commercial Building,  
111 Gloucester Road,  
Hong Kong



---

[11] 2322285.6M006

[15] 31-10-2023

[51] Cl. 12-16

[54] 汽車車身零件

Body part for vehicles

[73] Dr. Ing. h.c. F. Porsche Aktiengesellschaft  
Porscheplatz 1,  
70435 Stuttgart,  
Germany

[74] WENPING PATENT & TRADE MARK AGENT LIMITED  
1701 Tung Wai Commercial Building,  
111 Gloucester Road,  
Hong Kong



---

[11] 2322285.6M007

[15] 31-10-2023

[51] Cl. 12-16

[54] 汽車車身零件

Body part for vehicles

[73] Dr. Ing. h.c. F. Porsche Aktiengesellschaft

Porscheplatz 1,  
70435 Stuttgart,  
Germany

[74] WENPING PATENT & TRADE MARK AGENT LIMITED

1701 Tung Wai Commercial Building,  
111 Gloucester Road,  
Hong Kong



---

[11] 2322285.6M008

[15] 31-10-2023

[51] Cl. 12-16

[54] 汽車車身零件

Body part for vehicles

[73] Dr. Ing. h.c. F. Porsche Aktiengesellschaft

Porscheplatz 1,  
70435 Stuttgart,  
Germany

[74] WENPING PATENT & TRADE MARK AGENT LIMITED

1701 Tung Wai Commercial Building,  
111 Gloucester Road,  
Hong Kong

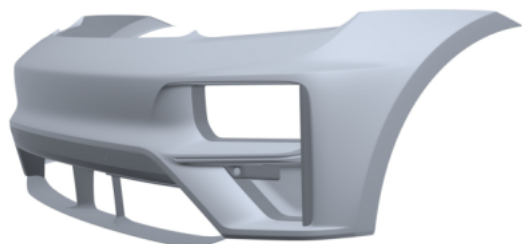

[11] 2322285.6M009

[15] 31-10-2023

[51] Cl. 12-16

[54] 汽車車身零件

Body part for vehicles

[73] Dr. Ing. h.c. F. Porsche Aktiengesellschaft

Porscheplatz 1,

70435 Stuttgart,

Germany

[74] WENPING PATENT & TRADE MARK AGENT LIMITED

1701 Tung Wai Commercial Building,

111 Gloucester Road,

Hong Kong



---

[11] 2322285.6M010

[15] 31-10-2023

[51] Cl. 12-16

[54] 汽車車身零件

Body part for vehicles

[73] Dr. Ing. h.c. F. Porsche Aktiengesellschaft

Porscheplatz 1,

70435 Stuttgart,

Germany

[74] WENPING PATENT & TRADE MARK AGENT LIMITED

1701 Tung Wai Commercial Building,

111 Gloucester Road,

Hong Kong

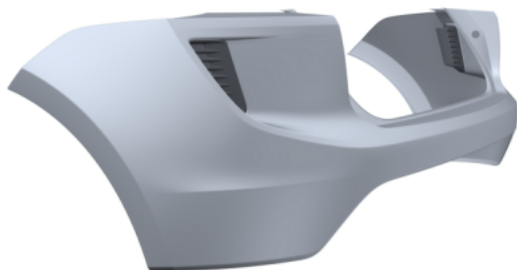

---

[11] 2322285.6M011

[15] 31-10-2023

[51] Cl. 12-16

[54] 汽車車身零件

Body part for vehicles

[73] Dr. Ing. h.c. F. Porsche Aktiengesellschaft

Porscheplatz 1,

70435 Stuttgart,

Germany

[74] WENPING PATENT & TRADE MARK AGENT LIMITED

1701 Tung Wai Commercial Building,

111 Gloucester Road,

Hong Kong

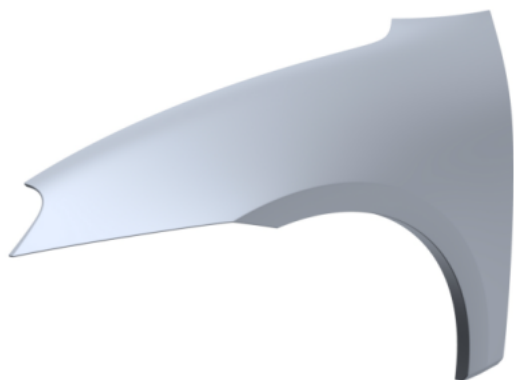

---

[11] 2322285.6M012

[15] 31-10-2023

[51] Cl. 12-16

[54] 汽車車身零件

Body part for vehicles

[73] Dr. Ing. h.c. F. Porsche Aktiengesellschaft

Porscheplatz 1,

70435 Stuttgart,

Germany

[74] WENPING PATENT & TRADE MARK AGENT LIMITED

1701 Tung Wai Commercial Building,

111 Gloucester Road,

Hong Kong



---

[11] 2322285.6M013

[15] 31-10-2023

[51] Cl. 12-16

[54] 汽車車身零件

Body part for vehicles

[73] Dr. Ing. h.c. F. Porsche Aktiengesellschaft

Porscheplatz 1,

70435 Stuttgart,

Germany

[74] WENPING PATENT & TRADE MARK AGENT LIMITED

1701 Tung Wai Commercial Building,

111 Gloucester Road,

Hong Kong

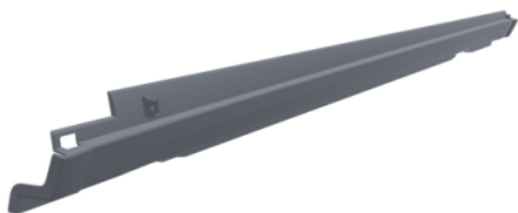

---

[11] 2322285.6M014

[15] 31-10-2023

[51] Cl. 12-16

[54] 汽車車身零件

Body part for vehicles

[73] Dr. Ing. h.c. F. Porsche Aktiengesellschaft

Porscheplatz 1,

70435 Stuttgart,

Germany



[74] WENPING PATENT & TRADE MARK AGENT LIMITED  
1701 Tung Wai Commercial Building,  
111 Gloucester Road,  
Hong Kong

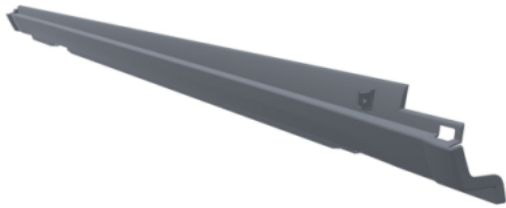

---

[11] 2322285.6M015

[15] 31-10-2023

[51] Cl. 12-16

[54] 汽車車身零件

Body part for vehicles

[73] Dr. Ing. h.c. F. Porsche Aktiengesellschaft  
Porscheplatz 1,  
70435 Stuttgart,  
Germany

[74] WENPING PATENT & TRADE MARK AGENT LIMITED  
1701 Tung Wai Commercial Building,  
111 Gloucester Road,  
Hong Kong

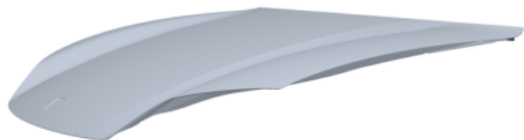

---

[11] 2322285.6M016

[15] 31-10-2023

[51] Cl. 12-16

[54] 汽車車身零件

Body part for vehicles

[73] Dr. Ing. h.c. F. Porsche Aktiengesellschaft  
Porscheplatz 1,  
70435 Stuttgart,  
Germany

[74] WENPING PATENT & TRADE MARK AGENT LIMITED  
1701 Tung Wai Commercial Building,  
111 Gloucester Road,  
Hong Kong

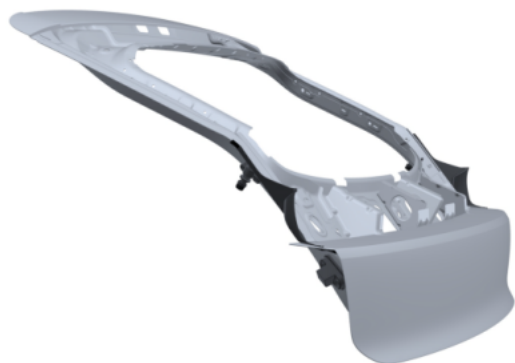

---

[11] 2322285.6M017

[15] 31-10-2023

[51] Cl. 12-16

[54] 汽車車身零件

Body part for vehicles

[73] Dr. Ing. h.c. F. Porsche Aktiengesellschaft

Porscheplatz 1,  
70435 Stuttgart,  
Germany

[74] WENPING PATENT & TRADE MARK AGENT LIMITED

1701 Tung Wai Commercial Building,  
111 Gloucester Road,  
Hong Kong

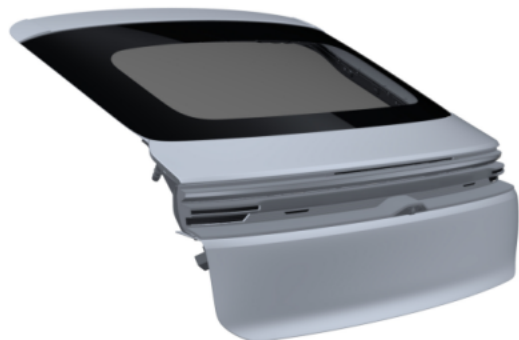

---

[11] 2322285.6M018

[15] 31-10-2023

[51] Cl. 12-16

[54] 汽車車身零件

Body part for vehicles

[73] Dr. Ing. h.c. F. Porsche Aktiengesellschaft

Porscheplatz 1,

70435 Stuttgart,  
Germany

[74] WENPING PATENT & TRADE MARK AGENT LIMITED  
1701 Tung Wai Commercial Building,  
111 Gloucester Road,  
Hong Kong



---

[11] 2322285.6M019

[15] 31-10-2023

[51] Cl. 12-16

[54] 車門

Door for vehicles

[73] Dr. Ing. h.c. F. Porsche Aktiengesellschaft  
Porscheplatz 1,  
70435 Stuttgart,  
Germany

[74] WENPING PATENT & TRADE MARK AGENT LIMITED  
1701 Tung Wai Commercial Building,  
111 Gloucester Road,  
Hong Kong



---

[11] 2322285.6M020

[15] 31-10-2023

[51] Cl. 12-16

[54] 車門

Door for vehicles

[73] Dr. Ing. h.c. F. Porsche Aktiengesellschaft

Porscheplatz 1,  
70435 Stuttgart,  
Germany

[74] WENPING PATENT & TRADE MARK AGENT LIMITED

1701 Tung Wai Commercial Building,  
111 Gloucester Road,  
Hong Kong



---

[11] 2322285.6M021

[15] 31-10-2023

[51] Cl. 12-16

[54] 汽車車身零件

Body part for vehicles

[73] Dr. Ing. h.c. F. Porsche Aktiengesellschaft

Porscheplatz 1,  
70435 Stuttgart,  
Germany

[74] WENPING PATENT & TRADE MARK AGENT LIMITED

1701 Tung Wai Commercial Building,  
111 Gloucester Road,  
Hong Kong

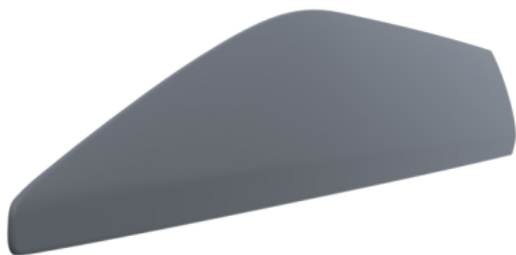

---

[11] 2322285.6M022

[15] 31-10-2023

[51] Cl. 12-16

[54] 車門

Door for vehicles

[73] Dr. Ing. h.c. F. Porsche Aktiengesellschaft

Porscheplatz 1,  
70435 Stuttgart,  
Germany

[74] WENPING PATENT & TRADE MARK AGENT LIMITED

1701 Tung Wai Commercial Building,  
111 Gloucester Road,  
Hong Kong



---

[11] 2322285.6M023

[15] 31-10-2023

[51] Cl. 12-16

[54] 車門

Door for vehicles

[73] Dr. Ing. h.c. F. Porsche Aktiengesellschaft

Porscheplatz 1,

70435 Stuttgart,  
Germany

[74] WENPING PATENT & TRADE MARK AGENT LIMITED  
1701 Tung Wai Commercial Building,  
111 Gloucester Road,  
Hong Kong



---

[11] 2322285.6M024

[15] 31-10-2023

[51] Cl. 12-16

[54] 汽車車身零件

Body part for vehicles

[73] Dr. Ing. h.c. F. Porsche Aktiengesellschaft  
Porscheplatz 1,  
70435 Stuttgart,  
Germany

[74] WENPING PATENT & TRADE MARK AGENT LIMITED  
1701 Tung Wai Commercial Building,  
111 Gloucester Road,  
Hong Kong

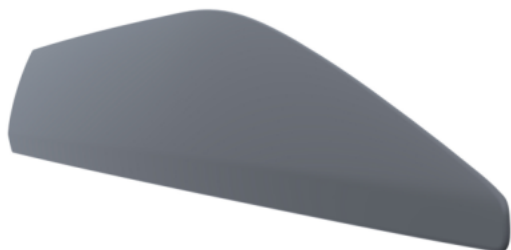

---

[11] 2322285.6M025

[15] 31-10-2023

[51] Cl. 12-16

[54] 車門

Door for vehicles

[73] Dr. Ing. h.c. F. Porsche Aktiengesellschaft

Porscheplatz 1,  
70435 Stuttgart,  
Germany

[74] WENPING PATENT & TRADE MARK AGENT LIMITED

1701 Tung Wai Commercial Building,  
111 Gloucester Road,  
Hong Kong



---

[11] 2322285.6M026

[15] 31-10-2023

[51] Cl. 12-16

[54] 車門

Door for vehicles

[73] Dr. Ing. h.c. F. Porsche Aktiengesellschaft

Porscheplatz 1,  
70435 Stuttgart,  
Germany

[74] WENPING PATENT & TRADE MARK AGENT LIMITED

1701 Tung Wai Commercial Building,  
111 Gloucester Road,  
Hong Kong



---

[11] 2322285.6M027

[15] 31-10-2023

[51] Cl. 12-16

[54] 汽車車身零件

Body part for vehicles

[73] Dr. Ing. h.c. F. Porsche Aktiengesellschaft

Porscheplatz 1,  
70435 Stuttgart,  
Germany

[74] WENPING PATENT & TRADE MARK AGENT LIMITED

1701 Tung Wai Commercial Building,  
111 Gloucester Road,  
Hong Kong



---

[11] 2322285.6M028

[15] 31-10-2023

[51] Cl. 12-16

[54] 車門

Door for vehicles



[73] Dr. Ing. h.c. F. Porsche Aktiengesellschaft  
Porscheplatz 1,  
70435 Stuttgart,  
Germany

[74] WENPING PATENT & TRADE MARK AGENT LIMITED  
1701 Tung Wai Commercial Building,  
111 Gloucester Road,  
Hong Kong



---

[11] 2322285.6M029

[15] 31-10-2023

[51] Cl. 12-16

[54] 車門

Door for vehicles

[73] Dr. Ing. h.c. F. Porsche Aktiengesellschaft  
Porscheplatz 1,  
70435 Stuttgart,  
Germany

[74] WENPING PATENT & TRADE MARK AGENT LIMITED  
1701 Tung Wai Commercial Building,  
111 Gloucester Road,  
Hong Kong



---

[11] 2322285.6M030

[15] 31-10-2023

[51] Cl. 12-16

[54] 汽車車身零件

Body part for vehicles

[73] Dr. Ing. h.c. F. Porsche Aktiengesellschaft

Porscheplatz 1,

70435 Stuttgart,

Germany

[74] WENPING PATENT & TRADE MARK AGENT LIMITED

1701 Tung Wai Commercial Building,

111 Gloucester Road,

Hong Kong



---

[11] 2322285.6M031

[15] 31-10-2023

[51] Cl. 12-16

[54] 汽車車身零件

Body part for vehicles

[73] Dr. Ing. h.c. F. Porsche Aktiengesellschaft  
Porscheplatz 1,  
70435 Stuttgart,  
Germany

[74] WENPING PATENT & TRADE MARK AGENT LIMITED  
1701 Tung Wai Commercial Building,  
111 Gloucester Road,  
Hong Kong



---

[11] 2322288.2M001

[15] 31-10-2023

[51] Cl. 12-16

[54] 車門把手

Door handle for vehicles

[73] Dr. Ing. h.c. F. Porsche Aktiengesellschaft  
Porscheplatz 1,  
70435 Stuttgart,  
Germany

[74] WENPING PATENT & TRADE MARK AGENT LIMITED  
1701 Tung Wai Commercial Building,  
111 Gloucester Road,  
Hong Kong

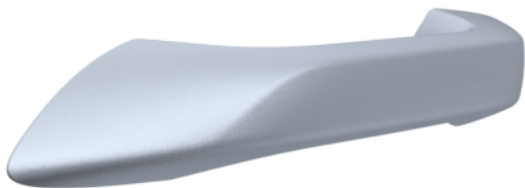

---

[11] 2322288.2M002

[15] 31-10-2023

[51] Cl. 12-16

[54] 車門把手

Door handle for vehicles

[73] Dr. Ing. h.c. F. Porsche Aktiengesellschaft  
Porscheplatz 1,  
70435 Stuttgart,  
Germany

[74] WENPING PATENT & TRADE MARK AGENT LIMITED  
1701 Tung Wai Commercial Building,  
111 Gloucester Road,  
Hong Kong

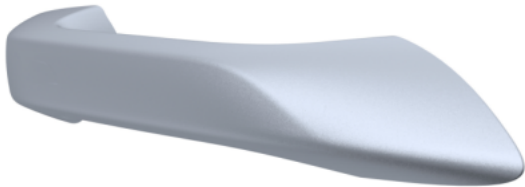

---

[11] 2322290.6M001

[15] 31-10-2023

[51] Cl. 26-06

[54] 汽車頭燈

Front lights for vehicles

[73] Dr. Ing. h.c. F. Porsche Aktiengesellschaft  
Porscheplatz 1,  
70435 Stuttgart,  
Germany

[74] WENPING PATENT & TRADE MARK AGENT LIMITED  
1701 Tung Wai Commercial Building,  
111 Gloucester Road,  
Hong Kong

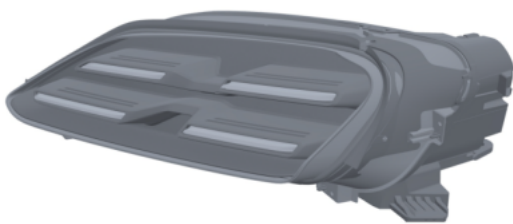

---

[11] 2322290.6M002

[15] 31-10-2023

[51] Cl. 26-06

[54] 汽車頭燈

Front lights for vehicles

[73] Dr. Ing. h.c. F. Porsche Aktiengesellschaft  
Porscheplatz 1,

70435 Stuttgart,  
Germany

[74] WENPING PATENT & TRADE MARK AGENT LIMITED  
1701 Tung Wai Commercial Building,  
111 Gloucester Road,  
Hong Kong

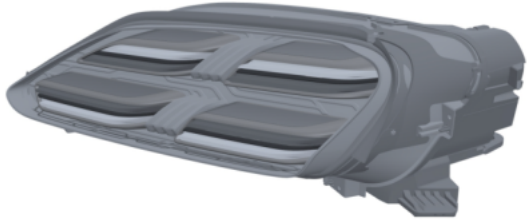

---

[11] 2322290.6M003

[15] 31-10-2023

[51] Cl. 26-06

[54] 汽車頭燈

Front lights for vehicles

[73] Dr. Ing. h.c. F. Porsche Aktiengesellschaft  
Porscheplatz 1,  
70435 Stuttgart,  
Germany

[74] WENPING PATENT & TRADE MARK AGENT LIMITED  
1701 Tung Wai Commercial Building,  
111 Gloucester Road,  
Hong Kong

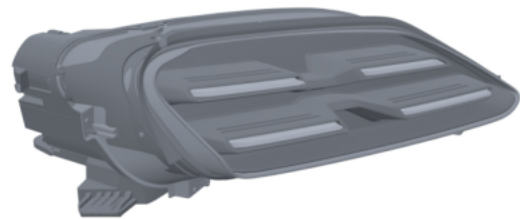

---

[11] 2322290.6M004

[15] 31-10-2023

[51] Cl. 26-06

[54] 汽車頭燈

Front lights for vehicles

[73] Dr. Ing. h.c. F. Porsche Aktiengesellschaft  
Porscheplatz 1,  
70435 Stuttgart,  
Germany

[74] WENPING PATENT & TRADE MARK AGENT LIMITED  
1701 Tung Wai Commercial Building,  
111 Gloucester Road,  
Hong Kong

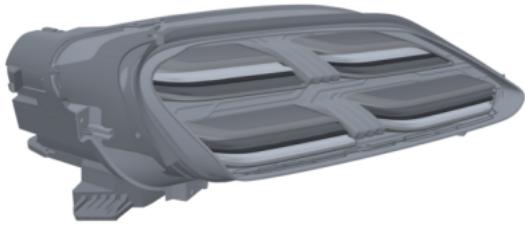

---

[11] 2322290.6M005

[15] 31-10-2023

[51] Cl. 26-06

[54] 汽車頭燈

Front lights for vehicles

[73] Dr. Ing. h.c. F. Porsche Aktiengesellschaft  
Porscheplatz 1,  
70435 Stuttgart,  
Germany

[74] WENPING PATENT & TRADE MARK AGENT LIMITED  
1701 Tung Wai Commercial Building,  
111 Gloucester Road,  
Hong Kong

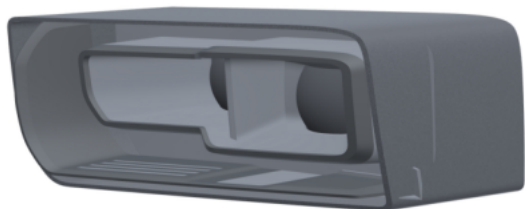

---

[11] 2322290.6M006

[15] 31-10-2023

[51] Cl. 26-06

[54] 汽車頭燈

Front lights for vehicles

[73] Dr. Ing. h.c. F. Porsche Aktiengesellschaft  
Porscheplatz 1,  
70435 Stuttgart,  
Germany

[74] WENPING PATENT & TRADE MARK AGENT LIMITED  
1701 Tung Wai Commercial Building,

111 Gloucester Road,  
Hong Kong

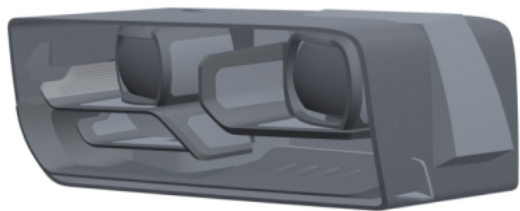

---

[11] 2322290.6M007

[15] 31-10-2023

[51] Cl. 26-06

[54] 汽車頭燈

Front lights for vehicles

[73] Dr. Ing. h.c. F. Porsche Aktiengesellschaft

Porscheplatz 1,

70435 Stuttgart,

Germany

[74] WENPING PATENT & TRADE MARK AGENT LIMITED

1701 Tung Wai Commercial Building,

111 Gloucester Road,

Hong Kong

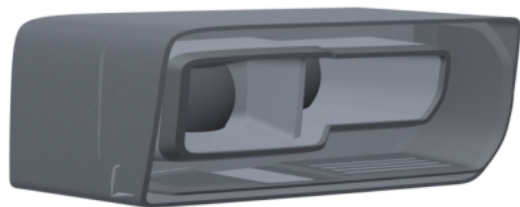

---

[11] 2322290.6M008

[15] 31-10-2023

[51] Cl. 26-06

[54] 汽車頭燈

Front lights for vehicles

[73] Dr. Ing. h.c. F. Porsche Aktiengesellschaft

Porscheplatz 1,

70435 Stuttgart,

Germany

[74] WENPING PATENT & TRADE MARK AGENT LIMITED

1701 Tung Wai Commercial Building,

111 Gloucester Road,

Hong Kong

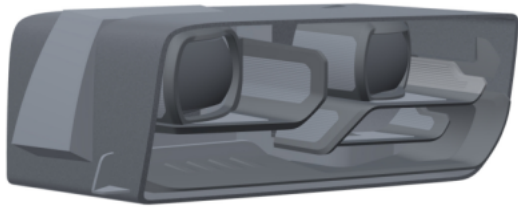

---

[11] 2322290.6M009

[15] 31-10-2023

[51] Cl. 26-06

[54] 汽車尾燈

Rear lights for vehicles

[73] Dr. Ing. h.c. F. Porsche Aktiengesellschaft

Porscheplatz 1,  
70435 Stuttgart,  
Germany

[74] WENPING PATENT & TRADE MARK AGENT LIMITED

1701 Tung Wai Commercial Building,  
111 Gloucester Road,  
Hong Kong

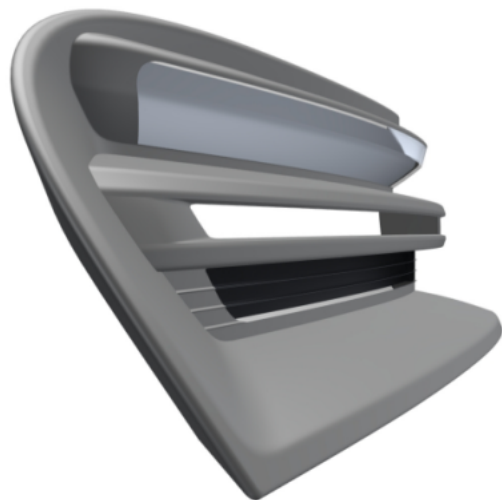

---

[11] 2322290.6M010

[15] 31-10-2023

[51] Cl. 26-06

[54] 汽車尾燈

Rear lights for vehicles

[73] Dr. Ing. h.c. F. Porsche Aktiengesellschaft

Porscheplatz 1,



70435 Stuttgart,  
Germany

[74] WENPING PATENT & TRADE MARK AGENT LIMITED  
1701 Tung Wai Commercial Building,  
111 Gloucester Road,  
Hong Kong



---

[11] 2322291.8M001

[15] 31-10-2023

[51] Cl. 21-01

[54] 模型車

Model car

[73] Dr. Ing. h.c. F. Porsche Aktiengesellschaft  
Porscheplatz 1,  
70435 Stuttgart,  
Germany

[74] WENPING PATENT & TRADE MARK AGENT LIMITED  
1701 Tung Wai Commercial Building,  
111 Gloucester Road,  
Hong Kong



---

[11] 2322291.8M002

[15] 31-10-2023

[51] Cl. 21-01

[54] 模型車

Model car

[73] Dr. Ing. h.c. F. Porsche Aktiengesellschaft

Porscheplatz 1,  
70435 Stuttgart,  
Germany

[74] WENPING PATENT & TRADE MARK AGENT LIMITED

1701 Tung Wai Commercial Building,  
111 Gloucester Road,  
Hong Kong



---

[11] 2322292.0M001

[15] 31-10-2023

[51] Cl. 12-08

[54] 汽車

Automobile

[73] Dr. Ing. h.c. F. Porsche Aktiengesellschaft

Porscheplatz 1,  
70435 Stuttgart,  
Germany

[74] WENPING PATENT & TRADE MARK AGENT LIMITED

1701 Tung Wai Commercial Building,  
111 Gloucester Road,  
Hong Kong



---

[11] 2322292.0M002

[15] 31-10-2023

[51] Cl. 12-08

[54] 汽車

Automobile

[73] Dr. Ing. h.c. F. Porsche Aktiengesellschaft

Porscheplatz 1,  
70435 Stuttgart,  
Germany

[74] WENPING PATENT & TRADE MARK AGENT LIMITED

1701 Tung Wai Commercial Building,  
111 Gloucester Road,  
Hong Kong



---

[11] 2322295.7M001

[15] 01-11-2023

[30] 18-08-2023 / DE / 40 2023 100 583.3

[51] Cl. 12-08

[54] 汽車

Motor vehicle

[73] VOLKSWAGEN AKTIENGESELLSCHAFT

Berliner Ring 2,  
38440 Wolfsburg,  
Germany

[74] CHINA PATENT AGENT (HONG KONG) LIMITED

22/F, Great Eagle Centre,  
23 Harbour Road,  
Wanchai, Hong Kong



- [11] 2322295.7M002  
[15] 01-11-2023  
[30] 18-08-2023 / DE / 40 2023 100 583.3  
[51] Cl. 12-08  
[54] 汽車  
Motor vehicle  
[73] VOLKSWAGEN AKTIENGESELLSCHAFT  
Berliner Ring 2,  
38440 Wolfsburg,  
Germany  
[74] CHINA PATENT AGENT (HONG KONG) LIMITED  
22/F, Great Eagle Centre,  
23 Harbour Road,  
Wanchai, Hong Kong



- 
- [11] 2322351.6M001  
[15] 16-11-2023  
[30] 25-10-2023 / JP / 022205 of 2023  
[51] Cl. 9-03  
[54] 包裝用容器  
Packing container  
[73] 久光製藥株式會社  
HISAMITSU PHARMACEUTICAL CO., INC.  
408, Tashirodaikan-machi,  
Tosu-shi, Saga 841-0017,  
Japan  
[74] WILKINSON & GRIST  
6th Floor, Prince's Building,  
Chater Road,  
Hong Kong

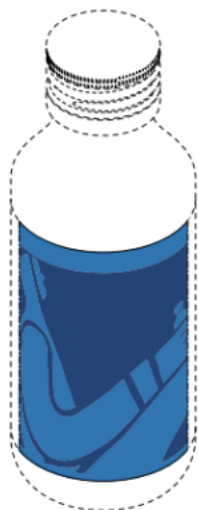

[11] 2322351.6M002

[15] 16-11-2023

[30] 25-10-2023 / JP / 022206 of 2023

[51] Cl. 9-03

[54] 包裝用容器

Packing container

[73] 久光製藥株式會社

HISAMITSU PHARMACEUTICAL CO., INC.

408, Tashirodaikan-machi,

Tosu-shi, Saga 841-0017,

Japan

[74] WILKINSON & GRIST

6th Floor, Prince's Building,

Chater Road,

Hong Kong



- [11] 2322351.6M003  
[15] 16-11-2023  
[30] 25-10-2023 / JP / 022207 of 2023  
[51] Cl. 9-03  
[54] 包裝用容器  
Packing container  
[73] 久光製藥株式會社  
HISAMITSU PHARMACEUTICAL CO., INC.  
408, Tashirodaikan-machi,  
Tosu-shi, Saga 841-0017,  
Japan  
[74] WILKINSON & GRIST  
6th Floor, Prince's Building,  
Chater Road,  
Hong Kong

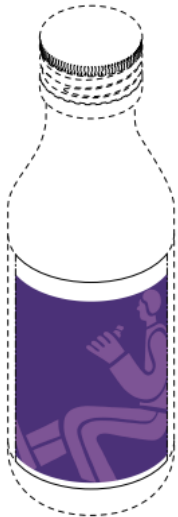

- 
- [11] 2322429.2M001  
[15] 28-11-2023  
[30] 05-06-2023 / US / 29/893,952  
[51] Cl. 14-04  
[54] 用於電腦顯示系統或其一部分的具有三維外觀的圖形用戶界面  
Graphical user interface having a three dimensional appearance  
for computer display system or portion thereof  
[73] 蘋果公司  
APPLE INC.  
One Apple Park Way Cupertino,  
California 95014,  
United States of America

[74] BARRON & YOUNG INTELLECTUAL PROPERTY LIMITED  
Suite 617, Lakeside 2,  
No. 10 Science Park West Avenue,  
Hong Kong Science Park, Shatin,  
New Territories, Hong Kong

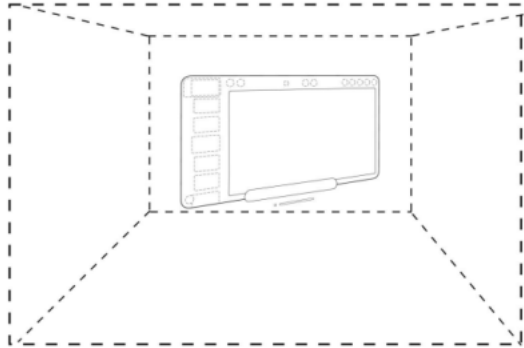

[11] 2322429.2M002

[15] 28-11-2023

[30] 05-06-2023 / US / 29/893,952

[51] Cl. 14-04

[54] 用於電腦顯示系統或其一部分的具有三維外觀的圖形用戶界面  
Graphical user interface having a three dimensional appearance  
for computer display system or portion thereof

[73] 蘋果公司  
APPLE INC.  
One Apple Park Way Cupertino,  
California 95014,  
United States of America

[74] BARRON & YOUNG INTELLECTUAL PROPERTY LIMITED  
Suite 617, Lakeside 2,  
No. 10 Science Park West Avenue,  
Hong Kong Science Park, Shatin,  
New Territories, Hong Kong

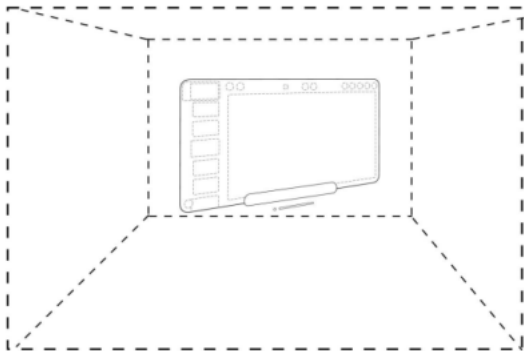

[11] 2322429.2M003

[15] 28-11-2023

[30] 05-06-2023 / US / 29/893,952

[51] Cl. 14-04

[54] 用於電腦顯示系統或其一部分的具有三維外觀的圖形用戶界面

Graphical user interface having a three dimensional appearance for computer display system or portion thereof

[73] 蘋果公司

APPLE INC.

One Apple Park Way Cupertino,

California 95014,

United States of America

[74] BARRON & YOUNG INTELLECTUAL PROPERTY LIMITED

Suite 617, Lakeside 2,

No. 10 Science Park West Avenue,

Hong Kong Science Park, Shatin,

New Territories, Hong Kong

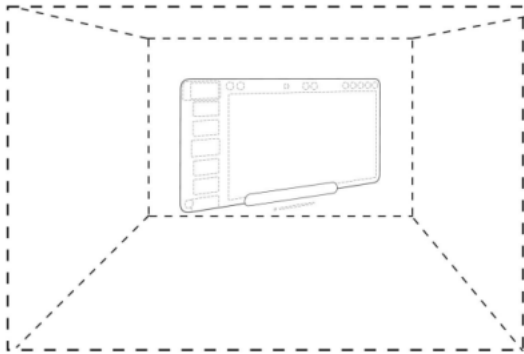

[11] 2322429.2M004

[15] 28-11-2023

[30] 05-06-2023 / US / 29/893,952

[51] Cl. 14-04

[54] 用於電腦顯示系統或其一部分的具有三維外觀的圖形用戶界面

Graphical user interface having a three dimensional appearance for computer display system or portion thereof

[73] 蘋果公司

APPLE INC.

One Apple Park Way Cupertino,

California 95014,

United States of America

[74] BARRON & YOUNG INTELLECTUAL PROPERTY LIMITED

Suite 617, Lakeside 2,

No. 10 Science Park West Avenue,

Hong Kong Science Park, Shatin,

New Territories, Hong Kong



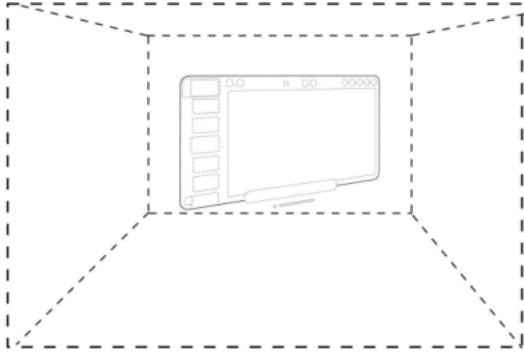

[11] 2322429.2M005

[15] 28-11-2023

[30] 05-06-2023 / US / 29/893,952

[51] Cl. 14-04

[54] 用於電腦顯示系統或其一部分的具有三維外觀的圖形用戶界面

Graphical user interface having a three dimensional appearance for computer display system or portion thereof

[73] 蘋果公司

APPLE INC.

One Apple Park Way Cupertino,

California 95014,

United States of America

[74] BARRON & YOUNG INTELLECTUAL PROPERTY LIMITED

Suite 617, Lakeside 2,

No. 10 Science Park West Avenue,

Hong Kong Science Park, Shatin,

New Territories, Hong Kong

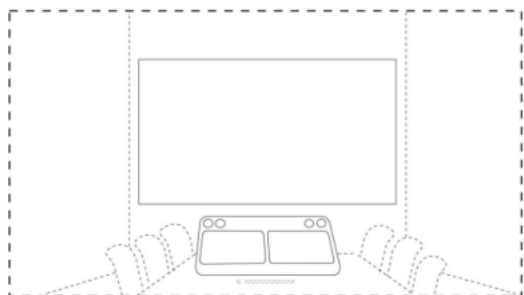

[11] 2322430.4

[15] 28-11-2023

[30] 05-06-2023 / US / 29/894,047

[51] Cl. 14-04

[54] 用於電腦顯示系統或其一部分的具有三維外觀的圖形用戶界面  
Graphical user interface having a three dimensional appearance  
for computer display system or portion thereof

[73] 蘋果公司  
APPLE INC.  
One Apple Park Way Cupertino,  
California 95014,  
United States of America

[74] BARRON & YOUNG INTELLECTUAL PROPERTY LIMITED  
Suite 617, Lakeside 2,  
No. 10 Science Park West Avenue,  
Hong Kong Science Park, Shatin,  
New Territories, Hong Kong

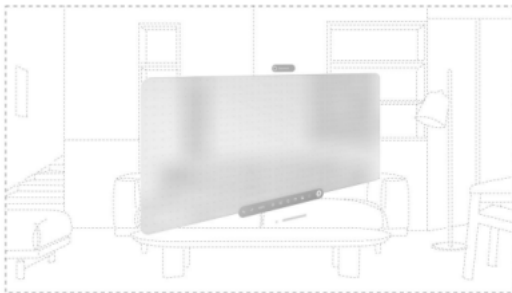

---

[11] 2322431.6M001

[15] 28-11-2023

[30] 03-06-2023 / US / 29/893,883

[51] Cl. 14-04

[54] 用於顯示屏或其一部分的圖形用戶界面  
Graphical user interface for display screen or portion thereof

[73] 蘋果公司  
APPLE INC.  
One Apple Park Way Cupertino,  
California 95014,  
United States of America

[74] BARRON & YOUNG INTELLECTUAL PROPERTY LIMITED  
Suite 617, Lakeside 2,  
No. 10 Science Park West Avenue,  
Hong Kong Science Park, Shatin,  
New Territories, Hong Kong



[11] 2322431.6M002

[15] 28-11-2023

[30] 03-06-2023 / US / 29/893,883

[51] Cl. 14-04

[54] 用於顯示屏或其一部分的圖形用戶界面

Graphical user interface for display screen or portion thereof

[73] 蘋果公司

APPLE INC.

One Apple Park Way Cupertino,

California 95014,

United States of America

[74] BARRON & YOUNG INTELLECTUAL PROPERTY LIMITED

Suite 617, Lakeside 2,

No. 10 Science Park West Avenue,

Hong Kong Science Park, Shatin,

New Territories, Hong Kong



[11] 2322441.7M001

[15] 29-11-2023

[30] 05-06-2023 / US / 29/893,961

[51] Cl. 14-04

[54] 用於電腦顯示系統或其一部分的具有三維外觀的圖形用戶界面

Graphical user interface having a three dimensional appearance  
for computer display system or portion thereof

[73] 蘋果公司

APPLE INC.

One Apple Park Way Cupertino,  
California 95014,  
United States of America

[74] BARRON & YOUNG INTELLECTUAL PROPERTY LIMITED

Suite 617, Lakeside 2,  
No. 10 Science Park West Avenue,  
Hong Kong Science Park, Shatin,  
New Territories, Hong Kong



[11] 2322441.7M002

[15] 29-11-2023

[30] 05-06-2023 / US / 29/893,961

[51] Cl. 14-04

[54] 用於電腦顯示系統或其一部分的具有三維外觀的圖形用戶界面

Graphical user interface having a three dimensional appearance  
for computer display system or portion thereof

[73] 蘋果公司

APPLE INC.

One Apple Park Way Cupertino,  
California 95014,  
United States of America

[74] BARRON & YOUNG INTELLECTUAL PROPERTY LIMITED

Suite 617, Lakeside 2,  
No. 10 Science Park West Avenue,  
Hong Kong Science Park, Shatin,  
New Territories, Hong Kong

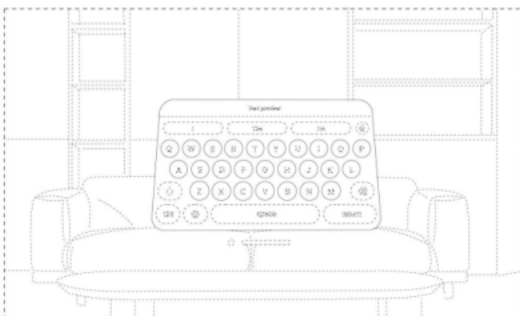

[11] 2322441.7M003

[15] 29-11-2023

[30] 05-06-2023 / US / 29/893,961

[51] Cl. 14-04

[54] 用於電腦顯示系統或其一部分的具有三維外觀的圖形用戶界面

Graphical user interface having a three dimensional appearance  
for computer display system or portion thereof

[73] 蘋果公司

APPLE INC.

One Apple Park Way Cupertino,  
California 95014,  
United States of America

[74] BARRON & YOUNG INTELLECTUAL PROPERTY LIMITED

Suite 617, Lakeside 2,  
No. 10 Science Park West Avenue,  
Hong Kong Science Park, Shatin,  
New Territories, Hong Kong

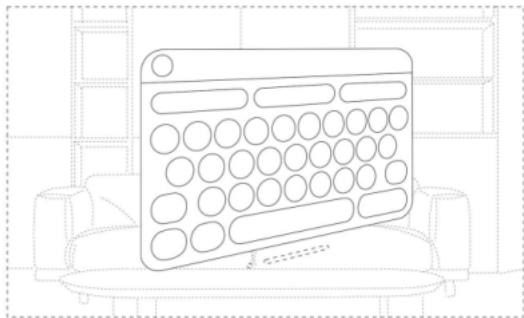

---

[11] 2322441.7M004

[15] 29-11-2023

[30] 05-06-2023 / US / 29/893,961

[51] Cl. 14-04

[54] 用於電腦顯示系統或其一部分的具有三維外觀的圖形用戶界面

Graphical user interface having a three dimensional appearance  
for computer display system or portion thereof

[73] 蘋果公司

APPLE INC.

One Apple Park Way Cupertino,  
California 95014,  
United States of America

[74] BARRON & YOUNG INTELLECTUAL PROPERTY LIMITED

Suite 617, Lakeside 2,  
No. 10 Science Park West Avenue,

Hong Kong Science Park, Shatin,  
New Territories, Hong Kong



[11] 2322443.1M001

[15] 30-11-2023

[30] 04-06-2023 / US / 29/893,912

[51] Cl. 14-04

[54] 用於顯示屏或其一部分的圖形用戶界面

Graphical user interface for display screen or portion thereof

[73] 蘋果公司

APPLE INC.

One Apple Park Way Cupertino,

California 95014,

United States of America

[74] BARRON & YOUNG INTELLECTUAL PROPERTY LIMITED

Suite 617, Lakeside 2,

No. 10 Science Park West Avenue,

Hong Kong Science Park, Shatin,

New Territories, Hong Kong

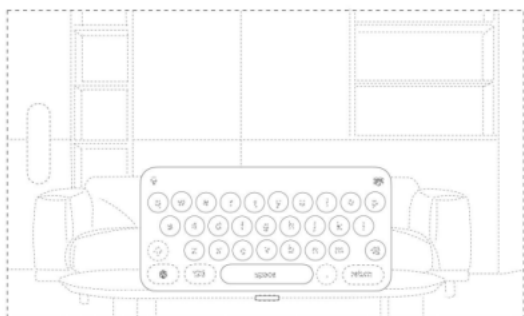

[11] 2322443.1M002

[15] 30-11-2023

[30] 04-06-2023 / US / 29/893,912

[51] Cl. 14-04

[54] 用於顯示屏或其一部分的圖形用戶界面  
Graphical user interface for display screen or portion thereof

[73] 蘋果公司  
APPLE INC.  
One Apple Park Way Cupertino,  
California 95014,  
United States of America

[74] BARRON & YOUNG INTELLECTUAL PROPERTY LIMITED  
Suite 617, Lakeside 2,  
No. 10 Science Park West Avenue,  
Hong Kong Science Park, Shatin,  
New Territories, Hong Kong

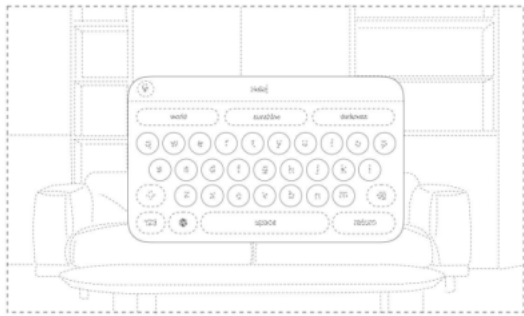

---

[11] 2322443.1M003

[15] 30-11-2023

[30] 04-06-2023 / US / 29/893,912

[51] Cl. 14-04

[54] 用於顯示屏或其一部分的圖形用戶界面  
Graphical user interface for display screen or portion thereof

[73] 蘋果公司  
APPLE INC.  
One Apple Park Way Cupertino,  
California 95014,  
United States of America

[74] BARRON & YOUNG INTELLECTUAL PROPERTY LIMITED  
Suite 617, Lakeside 2,  
No. 10 Science Park West Avenue,  
Hong Kong Science Park, Shatin,  
New Territories, Hong Kong



- 
- [11] 2422639.9M001  
[15] 10-01-2024  
[30] 04-12-2023 / CH, EU / WIPO141486  
[51] Cl. 10-07  
[54] 錶盤  
Watch dial  
[73] RICHEMONT INTERNATIONAL SA  
Route des Biches 10,  
1752 Villars-sur-Glâne,  
Switzerland  
[74] CHLOE LEE & CO.  
1104 Tai Tung Building,  
8 Fleming Road,  
Wanchai, Hong Kong

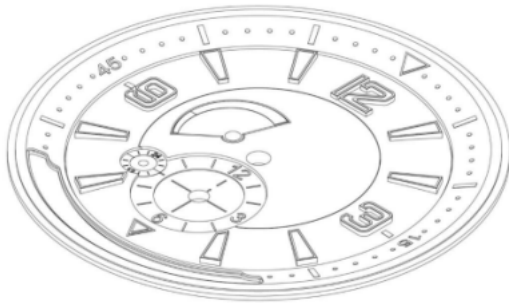

- 
- [11] 2422639.9M002  
[15] 10-01-2024  
[30] 04-12-2023 / CH, EU / WIPO141486  
[51] Cl. 10-07  
[54] 錶盤  
Watch dial  
[73] RICHEMONT INTERNATIONAL SA  
Route des Biches 10,  
1752 Villars-sur-Glâne,  
Switzerland



[74] CHLOE LEE & CO.  
1104 Tai Tung Building,  
8 Fleming Road,  
Wanchai, Hong Kong

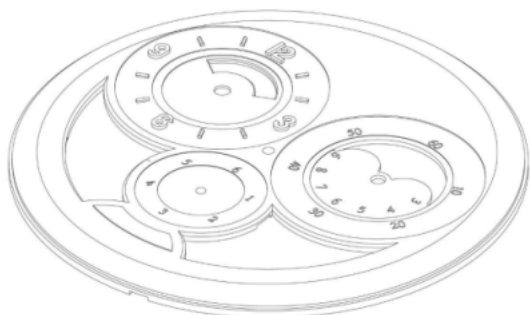

[11] 2422692.0

[15] 17-01-2024

[30] 15-08-2023 / CA, EG, BY, BA, LI, MK, MX, MC, ME, NO, OM, CN,  
SM, RU, SG, CH, TR, UA, GB, US, VN, EU, IS, JP, KR /  
WIPO136078

[51] Cl. 10-02

[54] 手錶  
Watch

[73] Turlen Holding SA  
Rue du Jura 11,  
2345 Les Breuleux,  
Switzerland

[74] WILKINSON & GRIST  
6th Floor, Prince's Building,  
Chater Road,  
Hong Kong

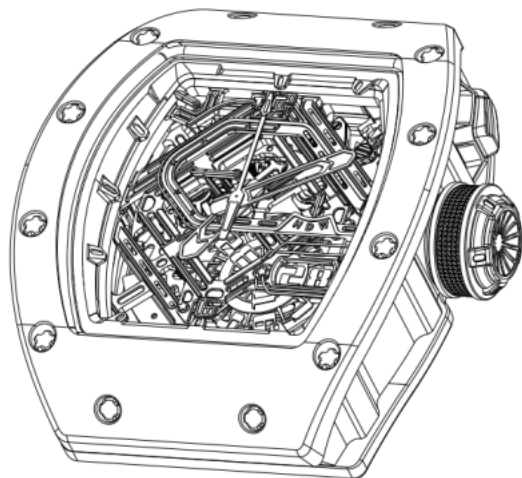

[11] 2422707.4M001

[15] 19-01-2024

[51] Cl. 10-07

[54] 錶帶

Watch band

[73] 歷新集團有限公司

Nextsun Group Limited

香港觀塘

偉業街 146 號

美嘉工業大廈 11 樓 A 室 25 號室

[74] 卓遠知識產權有限公司

香港上環

禧利街 27 號

富輝商業中心 10 樓

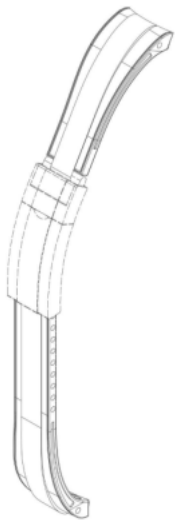

---

[11] 2422707.4M002

[15] 19-01-2024

[51] Cl. 10-07

[54] 錶扣

Watch clasp

[73] 歷新集團有限公司

Nextsun Group Limited

香港觀塘

偉業街 146 號

美嘉工業大廈 11 樓 A 室 25 號室

[74] 卓遠知識產權有限公司

香港上環

禧利街 27 號  
富輝商業中心 10 樓

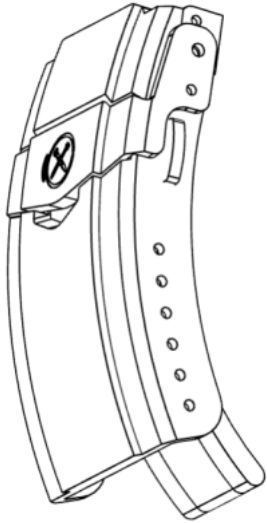

---

[11] 2422709.8

[15] 19-01-2024

[30] 20-07-2023 / CA, MC, SG, CH, GB, EU, JP, KR / DM/231 591

[51] Cl. 11-01

[54] 項鍊

Necklace

[73] CHAUMET INTERNATIONAL S.A.

12 Place Vendôme,

75001 Paris,

France

[74] WENPING PATENT & TRADE MARK AGENT LIMITED

1701 Tung Wai Commercial Building,

111 Gloucester Road,

Hong Kong



- [11] 2422710.0
- [15] 19-01-2024
- [51] Cl. 14-04
- [54] 用於環境控制系統的控制器進行操控的圖形化用戶介面  
Graphical user interface for controlling via a controller of environmental control system
- [73] 霍尼韋爾環境自控產品(天津)有限公司  
Honeywell Environmental & Combustion Controls (Tianjin) Co., Ltd.  
中國  
天津市經濟技術開發區  
南海路 158 號郵政編碼: 300457
- [74] CHINA PATENT AGENT (HONG KONG) LIMITED  
22/F, Great Eagle Centre,  
23 Harbour Road,  
Wanchai, Hong Kong



- [11] 2422725.2
- [15] 23-01-2024
- [30] 20-11-2023 / TW / 112305958
- [51] Cl. 26-02
- [54] 螢光棒  
Light stick
- [73] 相信音樂國際股份有限公司  
B'IN MUSIC INTERNATIONAL LIMITED  
6F., No. 12, Ln. 33,  
Guangfu S. Rd., Songshan Dist.,  
Taipei City 10563, Taiwan
- [74] MARKS & CLERK  
Level 9, Cyberport 1,  
100 Cyberport Road,  
Pok Fu Lam, Hong Kong

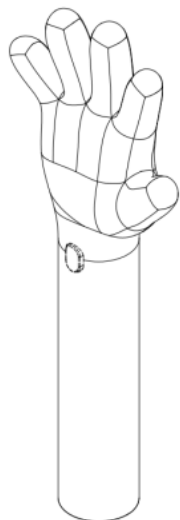

[11] 2422726.4

[15] 24-01-2024

[30] 11-10-2023 / CN / 202330657360.9

[51] Cl. 15-07

[54] 厚切酸奶冷藏櫃

Thickly sliced yogurt freezer

[73] 再森土環保科技(武漢)有限公司

ZAISENTU ENVIRONMENTAL PROTECTION TECHNOLOGY (WUHAN) CO., LTD.

中國 430000 湖北省

武漢市礄口區南泥灣大道 8 號

長豐科技產業園西區 7 號樓 101 室

[74] 香港專利商標代理有限公司

香港

皇后大道西 419K

博仕臺 10 樓 A 室



- [11] 2422734.0  
[15] 24-01-2024  
[30] 12-12-2023 / TW / 112306505  
[51] Cl. 9-05  
[54] 泡殼  
Blister pack  
[73] 相信音樂國際股份有限公司  
B' IN MUSIC INTERNATIONAL LIMITED  
6F., No. 12, Ln. 33,  
Guangfu S. Rd., Songshan Dist.,  
Taipei City 10563, Taiwan  
[74] MARKS & CLERK  
Level 9, Cyberport 1,  
100 Cyberport Road,  
Pok Fu Lam, Hong Kong

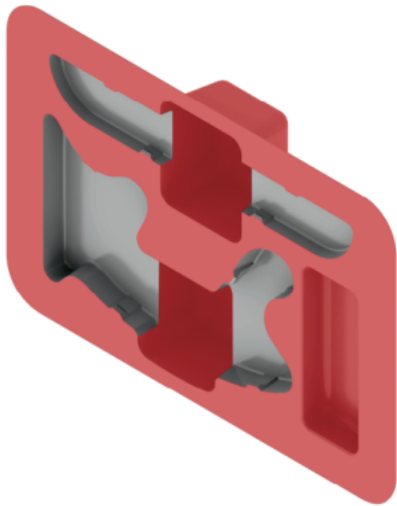

- 
- [11] 2422735.3  
[15] 24-01-2024  
[30] 12-12-2023 / TW / 112306504  
[51] Cl. 9-05  
[54] 泡殼  
Blister pack  
[73] 相信音樂國際股份有限公司  
B' IN MUSIC INTERNATIONAL LIMITED  
6F., No. 12, Ln. 33,  
Guangfu S. Rd., Songshan Dist.,  
Taipei City 10563, Taiwan

[74] MARKS & CLERK  
Level 9, Cyberport 1,  
100 Cyberport Road,  
Pok Fu Lam, Hong Kong

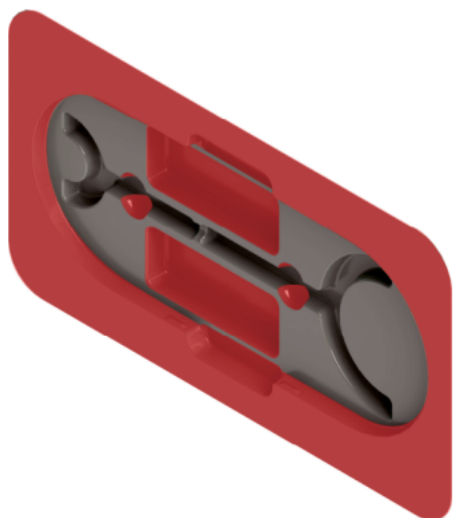

---

[11] 2422747.8

[15] 29-01-2024

[51] Cl. 20-02

[54] 鑽飾展示設備儀  
Jewelry display unit

[73] 深圳市上源藝術設計有限公司  
Shenzhen Shangyuan Art Design CO., Ltd.  
中國深圳市  
羅湖區翠竹街道水貝二路  
特力珠寶大廈 B 座 17 層 1701-11

[74] 卓遠知識產權有限公司  
香港上環  
禧利街 27 號  
富輝商業中心 10 樓



---

[11] 2422748.0

[15] 29-01-2024

[51] Cl. 14-04

[54] 圖形用戶界面

Graphical user interface

[73] NCSOFT Corporation

(Samseong-dong) 509, Teheran-ro,

Gangnam-gu, Seoul 06169,

Republic of Korea

[74] BAKER & MCKENZIE

14th Floor, One Taikoo Place,

979 King's Road,

Quarry Bay, Hong Kong



---

[11] 2422749.2



[15] 29-01-2024

[51] Cl. 14-04

[54] 圖形用戶界面

Graphical user interface

[73] NCSOFT Corporation

(Samseong-dong) 509, Teheran-ro,

Gangnam-gu, Seoul 06169,

Republic of Korea

[74] BAKER & MCKENZIE

14th Floor, One Taikoo Place,

979 King's Road,

Quarry Bay, Hong Kong



---

[11] 2422750.4

[15] 29-01-2024

[51] Cl. 14-04

[54] 圖形用戶界面

Graphical user interface

[73] NCSOFT Corporation

(Samseong-dong) 509, Teheran-ro,

Gangnam-gu, Seoul 06169,

Republic of Korea

[74] BAKER & MCKENZIE

14th Floor, One Taikoo Place,

979 King's Road,

Quarry Bay, Hong Kong



---

[11] 2422751.6

[15] 29-01-2024

[51] Cl. 14-04

[54] 圖形用戶界面

Graphical user interface

[73] NCSOFT Corporation

(Samseong-dong) 509, Teheran-ro,  
Gangnam-gu, Seoul 06169,  
Republic of Korea

[74] BAKER & MCKENZIE

14th Floor, One Taikoo Place,  
979 King's Road,  
Quarry Bay, Hong Kong



---

[11] 2422753.0

[15] 29-01-2024

[30] 07-09-2023 / JP / 018300 of 2023

[51] Cl. 18-99

[54] 標籤打印機

Label printer

[73] 卡西歐計算機株式會社

CASIO KEISANKI KABUSHIKI KAISHA d.b.a. CASIO  
COMPUTER CO., LTD.

6-2, Hon-Machi 1-Chome,  
Shibuya-Ku, Tokyo,  
Japan

[74] CHINA PATENT AGENT (HONG KONG) LIMITED

22/F, Great Eagle Centre,  
23 Harbour Road,  
Wanchai, Hong Kong

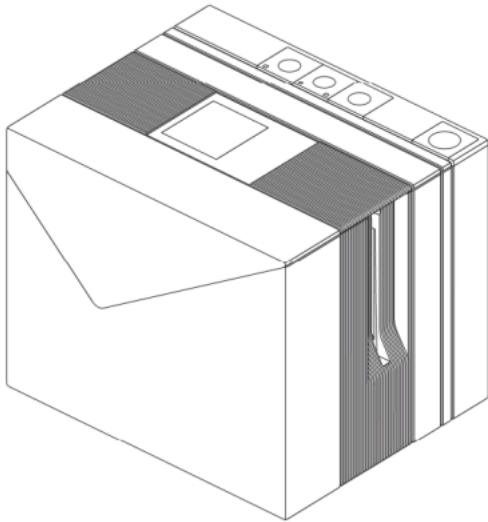

---

[11] 2422754.2M001

[15] 29-01-2024

[51] Cl. 2-04

[54] 鞋底

Sole for footwear

[73] AIRWAIR INTERNATIONAL LIMITED

Cobb's Lane, Wollaston, Wellingborough,  
Northamptonshire NN29 7SW,  
United Kingdom

[74] HOGAN LOVELLS

11th Floor, One Pacific Place,  
88 Queensway,  
Hong Kong



---

[11] 2422754.2M002

[15] 29-01-2024

[51] Cl. 2-04

[54] 鞋底

Sole for footwear

[73] AIRWAIR INTERNATIONAL LIMITED

Cobb's Lane, Wollaston, Wellingborough,  
Northamptonshire NN29 7SW,  
United Kingdom

[74] HOGAN LOVELLS

11th Floor, One Pacific Place,  
88 Queensway,  
Hong Kong



---

[11] 2422754.2M003

[15] 29-01-2024

[51] Cl. 2-04

[54] 鞋底

Sole for footwear

[73] AIRWAIR INTERNATIONAL LIMITED

Cobb's Lane, Wollaston, Wellingborough,  
Northamptonshire NN29 7SW,  
United Kingdom

- [74] HOGAN LOVELLS  
11th Floor, One Pacific Place,  
88 Queensway,  
Hong Kong



- 
- [11] 2422762.9M001  
[15] 30-01-2024  
[30] 30-08-2023 / CA, AM, AZ, BZ, BA, GE, LI, MK, MD, MC, MN, ME,  
MA, NO, OM, SG, CH, TN, TR, UA, GB, EU, AL, KG / DM/231 762  
[51] Cl. 11-01  
[54] 指環  
Ring  
[73] Harry Winston SA  
Chemin du Tourbillon 8,  
CH-1228 Plan-les-Ouates,  
Switzerland  
[74] SPRUSON & FERGUSON (HONG KONG) LIMITED  
5001 Hopewell Centre,  
183 Queen's Road East,  
Wan Chai, Hong Kong



- 
- [11] 2422762.9M002

- [15] 30-01-2024
- [30] 30-08-2023 / CA, AM, AZ, BZ, BA, GE, LI, MK, MD, MC, MN, ME, MA, NO, OM, SG, CH, TN, TR, UA, GB, EU, AL, KG / DM/231 762
- [51] Cl. 11-01
- [54] 指環  
Ring
- [73] Harry Winston SA  
Chemin du Tourbillon 8,  
CH-1228 Plan-les-Ouates,  
Switzerland
- [74] SPRUSON & FERGUSON (HONG KONG) LIMITED  
5001 Hopewell Centre,  
183 Queen's Road East,  
Wan Chai, Hong Kong



- 
- [11] 2422762.9M003
- [15] 30-01-2024
- [30] 30-08-2023 / CA, AM, AZ, BZ, BA, GE, LI, MK, MD, MC, MN, ME, MA, NO, OM, SG, CH, TN, TR, UA, GB, EU, AL, KG / DM/231 762
- [51] Cl. 11-01
- [54] 指環  
Ring
- [73] Harry Winston SA  
Chemin du Tourbillon 8,  
CH-1228 Plan-les-Ouates,  
Switzerland
- [74] SPRUSON & FERGUSON (HONG KONG) LIMITED  
5001 Hopewell Centre,  
183 Queen's Road East,  
Wan Chai, Hong Kong



---

[11] 2422762.9M004

[15] 30-01-2024

[30] 30-08-2023 / CA, AM, AZ, BZ, BA, GE, LI, MK, MD, MC, MN, ME, MA, NO, OM, SG, CH, TN, TR, UA, GB, EU, AL, KG / DM/231 762

[51] Cl. 11-01

[54] 耳環

Earrings

[73] Harry Winston SA  
Chemin du Tourbillon 8,  
CH-1228 Plan-les-Ouates,  
Switzerland

[74] SPRUSON & FERGUSON (HONG KONG) LIMITED  
5001 Hopewell Centre,  
183 Queen's Road East,  
Wan Chai, Hong Kong



---

[11] 2422762.9M005

[15] 30-01-2024

[30] 30-08-2023 / CA, AM, AZ, BZ, BA, GE, LI, MK, MD, MC, MN, ME, MA, NO, OM, SG, CH, TN, TR, UA, GB, EU, AL, KG / DM/231 762

[51] Cl. 11-01

[54] 耳環

Earrings

[73] Harry Winston SA

Chemin du Tourbillon 8,  
CH-1228 Plan-les-Ouates,  
Switzerland

[74] SPRUSON & FERGUSON (HONG KONG) LIMITED

5001 Hopewell Centre,  
183 Queen's Road East,  
Wan Chai, Hong Kong

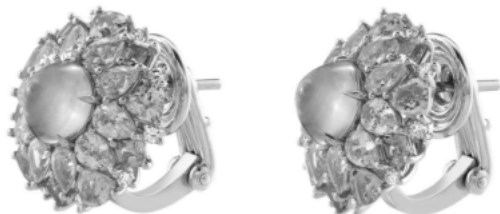

---

[11] 2422774.4

[15] 01-02-2024

[30] 23-08-2023 / CA, NO, SG, CH, GB, EU, JP, KR / DM/231 461

[51] Cl. 7-02

[54] 電熱水壺

Electric water kettle

[73] Pi-Design AG

Altgasse 82,  
CH-6340 Baar,  
Switzerland

[74] WENPING PATENT & TRADE MARK AGENT LIMITED

1701 Tung Wai Commercial Building,  
111 Gloucester Road,  
Hong Kong



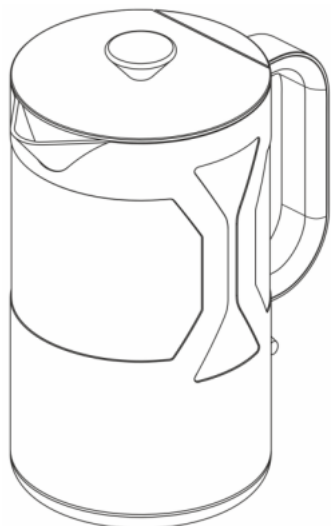

---

[11] 2422776.9

[15] 01-02-2024

[51] Cl. 14-03

[54] 無線射頻天線

Wireless RF antenna

[73] 廣東中世發智能科技股份有限公司

Guangdong Zhongshifa Intelligent Technology Co., Ltd.

中國廣東省

珠海市斗門區

白蕉科技寶亞園新科路 43 號 (一期廠房)

[74] LISHI INTELLECTUAL PROPERTY GROUP (INTERNATIONAL) LIMITED

香港九龍觀塘

興業街 15-17 號

中美中心 B 座 9 樓 9045 室



---

[11] 2422780.7

[15] 02-02-2024

[51] Cl. 11-01

[54] 手環

Bracelet

[73] 沃倫勒夫(香港)有限公司

WARRENSLOVE (HONG KONG) LIMITED

香港九龍旺角

彌敦道 610 號

荷李活商業中心 1318-19 室

[74] 王昌花

香港元朗

屏康里 20 號

寶珊園 3 座 2D





香港特別行政區政府知識產權署外觀設計註冊處

The Government of the Hong Kong Special Administrative Region

Designs Registry, Intellectual Property Department

根據註冊外觀設計條例第 28 條，下列註冊外觀設計因未繳續期費而停止有效。

各組記項按註冊外觀設計停止有效日期及註冊編號先後次序排列。

**Registered designs ceased through non-payment of renewal fees under section 28 of the Registered Designs Ordinance. Entries are listed below under their expiry dates.**

**02-02-2024 - 07-02-2024**

**02-02-2024**

0900167.2

**03-02-2024**

0900174.6

**05-02-2024**

0410266.9

**06-02-2024**

1400210.1

1400213.7M001

1400213.7M002

1400213.7M003

1400213.7M004

1400213.7M005

1400213.7M006

1400213.7M007

1400213.7M008

1400213.7M009

1400213.7M010

1400851.0M001

1400851.0M002

**07-02-2024**

1913028.5



香港特別行政區政府知識產權署外觀設計註冊處

The Government of the Hong Kong Special Administrative Region

Designs Registry, Intellectual Property Department

根據註冊外觀設計規則第 31 條刪除的註冊外觀設計。各組記項按註冊外觀設計刪除日期及註冊編號先後次序排列。

**Registered designs removed under section 31 of the Registered Designs Rules. Entries are listed below under their removal dates.**

**09-02-2024 - 15-02-2024**

<b>09-02-2024</b>	1801598.8M002	0801968.1M001
1301322.8	1801598.8M003	0801969.3
1301323.0	1801599.0	1801633.3
1301324.2	1801600.4	1801634.5
1301325.5	1801605.5	1801635.8
1301326.7	1801608.1	
1801568.5	1801609.3	
1801569.7		
1801570.9	<b>11-02-2024</b>	
1801571.1	0801935.2	
1801572.3		
1801573.5	<b>13-02-2024</b>	
1801574.7	1801612.9	
1801575.0	1801614.3	
1801576.2		
1801577.4	<b>14-02-2024</b>	
1801578.6	0801954.1M005	
1801579.8	0801954.1M006	
1801580.0	0801961.6M031	
1801581.2	0801962.8M001	
1801582.4	0801962.8M002	
1801583.6	0900242.1	
1801584.8	1301347.1	
1801585.1	1801620.6	
1801586.3	1801621.8	
1801587.5	1801623.2	
1801590.1	1801624.4M001	
1801591.3M001	1801624.4M002	
1801591.3M002	1801624.4M003	
1801591.3M003	1801624.4M004	
	1801624.4M005	

**10-02-2024**1801594.9  
1801595.2**15-02-2024**

0311274.5