

香港知識產權公報

Hong Kong Intellectual Property Journal

2024年8月9日

09 August 2024

目錄 Contents

根據註冊外觀設計條例第 25 條註冊的外觀設計

Designs Registered under section 25 of the Registered Designs Ordinance

按註冊編號排列

Arranged by Registration Number

根據註冊外觀設計條例(第 522 章)公布的其他公告

Other Notices Published under the Registered Designs Ordinance (Cap. 522)

根據註冊外觀設計條例第 28 條，註冊外觀設計因未繳續期費而停止有效

Registered designs ceased through non-payment of renewal fees under section 28 of the Registered Designs Ordinance

根據註冊外觀設計規則第 31 條刪除的註冊外觀設計

Registered designs removed under section 31 of the Registered Designs Rules

以下事項沒有記錄

No Records for the Following Matters

根據註冊外觀設計條例第 30 條放棄的外觀設計的註冊

Surrender of Registration of Design under section 30 of the Registered Designs Ordinance

根據註冊外觀設計規則第 37 條，向處長作出轉介

Reference to Registrar under section 37 of the Registered Designs Rules

根據註冊外觀設計條例第 45 條，撤銷註冊

Revocation of Registration under section 45 of the Registered Designs Ordinance

根據註冊外觀設計規則第 46 條，向法院作出轉介

Reference to Court under section 46 of the Registered Designs Rules

根據註冊外觀設計規則第 63 條對不符合規定之處作出糾正

Rectification of Irregularities under section 63 of the Registered Designs Rules

根據註冊外觀設計條例第 66 條，糾正註冊紀錄冊

Rectification of Register under section 66 of the Registered Designs Ordinance

根據註冊外觀設計條例第 67 條 更正註冊紀錄冊內的錯誤

Correction of errors in Register under section 67 of the Registered Designs Ordinance

根據註冊外觀設計條例第 67 及 76 條，更正註冊紀錄冊內及已提交文件中的錯誤

Correction of Errors in Register and in Filed Documents under sections 67 and 76 of the Registered Designs Ordinance

根據註冊外觀設計條例第 76 條，更正已提交文件中的錯誤

Correction of errors in filed documents under section 76 of the Registered Designs Ordinance

勘誤

Corrigendum

註冊外觀設計公告註釋

Notes on advertisements of registration of designs

方括號表示下列資料：

Square brackets indicate the following data：

[11] 註冊編號 Registration number / 聯合王國註冊編號 United Kingdom registration number

[15] 註冊日期 Registration date / 當作註冊日期 Deemed registration date / 聯合王國註冊日期 United Kingdom registration date

[17] 註冊有效期屆滿日期 Expiry date of the period of registration

[22] 提交日期 Filing date / 當作提交日期 Deemed filing date / 聯合王國提交日期 United Kingdom filing date

[30] 聲稱享有的優先權（提交日期 / 巴黎公約國或世界貿易組織成員 / 申請編號） Priority claimed (filing date / Paris Convention country or WTO member / application number)

[51] 國際外觀設計分類號（洛迦諾分類號） International Classification of designs (Locarno Classification)

[54] 物品 Article

[55] 外觀設計的表述 Representation of the design

[62] 分開前的申請編號及提交日期 Application number before division and filing date

[66] 過往註冊的聯繫外觀設計註冊編號 / 日期 Registration No. / Date of Previous Registration for Association

[72] 設計人 Designer

[73] 擁有人姓名和地址 Name and address of the owner

[74] 代理人 Agent /送達地址 Address for service



香港特別行政區政府知識產權署外觀設計註冊處
The Government of the Hong Kong Special Administrative Region
Designs Registry, Intellectual Property Department

根據註冊外觀設計條例第 25 條註冊的外觀設計

Designs registered under section 25 of the Registered Designs Ordinance

按註冊編號排列

Arranged by Registration Number

- [11] 2423037.3
- [15] 26-03-2024
- [30] 27-09-2023 / CN / 2023306345439
27-09-2023 / CN / 2023306345674
- [51] Cl. 21-01
- [54] 玩具(飛機造型)
Toy (airplane shape)
- [73] 汕頭市兒超喜智能科技實業有限公司
中國廣東省
汕頭市澄海區
廣益街道登峰路廣峰工業區 3 號
- [74] 聚一知識產權有限公司
香港九龍尖沙咀
嘉蘭圍 5-11 號
利時商業大廈 1813 號



-
- [11] 2423038.5
 - [15] 26-03-2024

[30] 27-09-2023 / CN / 2023306344991
27-09-2023 / CN / 2023306345797

[51] Cl. 21-01

[54] 玩具 (劍龍造型)
Toy (stegosaurus shape)

[73] 汕頭市兒超喜智能科技實業有限公司
中國廣東省
汕頭市澄海區
廣益街道登峰路廣峰工業區 3 號

[74] 聚一知識產權有限公司
香港九龍尖沙咀
嘉蘭圍 5-11 號
利時商業大廈 1813 号

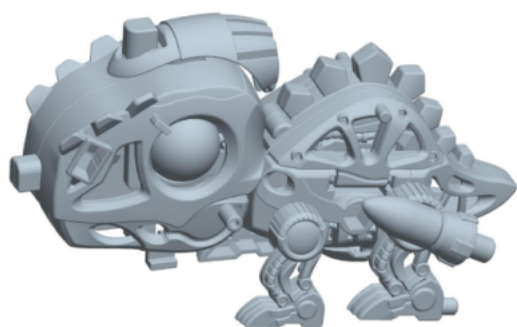

[11] 2423048.6

[15] 27-03-2024

[30] 02-10-2023 / FR / 20234154

[51] Cl. 3-01

[54] 袋
Bag

[73] LOUIS VUITTON MALLETIER
2 rue du Pont-Neuf,
75001 Paris,
France

[74] BAKER & MCKENZIE
14th Floor, One Taikoo Place,
979 King's Road,
Quarry Bay, Hong Kong



[11] 2423051.2

[15] 27-03-2024

[30] 29-09-2023 / JP / 2023-020216

[51] Cl. 2-02

[54] 襯衫
Shirt

[73] 株式會社 MTG
MTG CO., LTD.
2-32 Honjin-tori, Nakamura-ku,
Nagoya-shi, Aichi 4530041,
Japan

[74] CHINAHONGKONG IP LIMITED
1502, 15/F, Capital Centre,
151 Gloucester Road,
Wanchai, Hong Kong



[11] 2423200.9M001

[15] 23-04-2024

[30] 27-10-2023 / EU / 015038544-0001

[51] Cl. 26-06

[54] 汽車頭燈

Front lights for vehicles

[73] Bugatti International S.A.

412F route d'Esch,

1030 Luxembourg,

Luxembourg

[74] WENPING PATENT & TRADE MARK AGENT LIMITED

1701 Tung Wai Commercial Building,

111 Gloucester Road,

Hong Kong

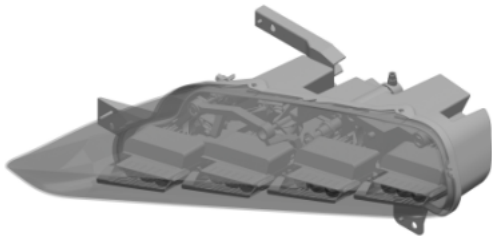

[11] 2423200.9M002

[15] 23-04-2024

[30] 27-10-2023 / EU / 015038544-0002

[51] Cl. 26-06

[54] 汽車頭燈

Front lights for vehicles

[73] Bugatti International S.A.

412F route d'Esch,

1030 Luxembourg,

Luxembourg

[74] WENPING PATENT & TRADE MARK AGENT LIMITED

1701 Tung Wai Commercial Building,

111 Gloucester Road,

Hong Kong

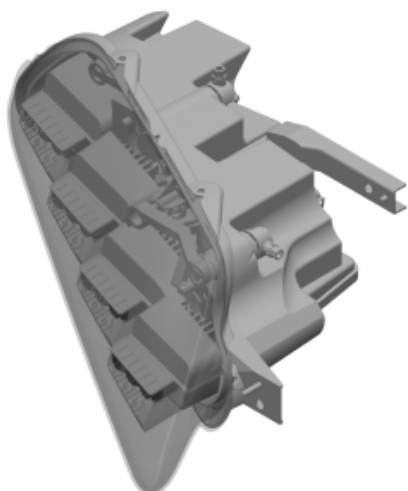

[11] 2423200.9M003

[15] 23-04-2024

[30] 27-10-2023 / EU / 015038544-0003

[51] Cl. 26-06

[54] 汽車尾燈

Rear lights for vehicles

[73] Bugatti International S.A.

412F route d'Esch,

1030 Luxembourg,

Luxembourg

[74] WENPING PATENT & TRADE MARK AGENT LIMITED

1701 Tung Wai Commercial Building,

111 Gloucester Road,

Hong Kong



[11] 2423227.6

[15] 26-04-2024

[30] 29-11-2023 / CA, BR, MX, CN, GB, US, VN, EU, JP, KR /
DM/234322

[51] Cl. 9-03

[54] 包裝盒

Packaging box

[73] LABORATOIRE FRANCAIS DU FRACTIONNEMENT ET DES BIOTECHNOLOGIES

Tour W - 102 Terrasse Boieldieu,
19ème Etage, 92800 PUTEAUX,
FRANCE

[74] MELVIN LI INTELLECTUAL PROPERTY LIMITED

Level 35, Two Pacific Place,
88 Queensway, Admiralty,
Hong Kong



[11] 2423258.1

[15] 02-05-2024

[51] Cl. 21-01

[54] 卡通飛鼠

Cartoon flying squirrel

[73] 乜都有有限公司

Multi Products (HK) Limited
UNIT 813-814, 8/F, HOPE SEA IND CTR,
26 LAM HING ST, KOWLOON BAY, KOWLOON,
HONG KONG

[74] TRADEMARKCN COMPANY LIMITED

Block A, 4/F., Granville Building,
14 Granville Road, Tsim Sha Tsui, Kowloon,
Hong Kong



[11] 2423270.6

[15] 06-05-2024

[30] 06-11-2023 / EU / 015040054-0001

[51] Cl. 26-06

[54] 車燈

Vehicle light

[73] 浙江吉利控股集團有限公司

Zhejiang Geely Holding Group Co., Ltd.

中國

浙江省杭州市濱江區

江陵路 1760 號 (郵編: 310051)

浙江極氪智能科技有限公司

Zhejiang Zeekr Intelligent Technology Co., Ltd

中國

浙江省寧波市北侖區新碶街道遼河路

商務大廈 1 幢 1031 室 (郵編: 315000)

[74] 普衡知識產權代理有限公司

香港

九龍尖沙咀柯士甸道 122 號

麗斯中心 10 樓 B 室場地號 15



[11] 2423271.8

[15] 06-05-2024

[30] 06-11-2023 / EU / 015039909-0003

[51] Cl. 12-16

[54] 車輛部件

Vehicle part

[73] 浙江吉利控股集團有限公司

Zhejiang Geely Holding Group Co., Ltd.

中國

浙江省杭州市濱江區

江陵路 1760 號 (郵編: 310051)

浙江極氫智能科技有限公司

Zhejiang Zeekr Intelligent Technology Co., Ltd

中國

浙江省寧波市北侖區新碶街道遼河路

商務大廈 1 幢 1031 室 (郵編: 315000)

[74] 普衡知識產權代理有限公司

香港

九龍尖沙咀柯士甸道 122 號

麗斯中心 10 樓 B 室場地號 15



[11] 2423511.9M001

[15] 13-06-2024

[51] Cl. 11-01

[54] 戒指

Ring

[73] 吳子康

Ng Tsz Hong

2/F, 174, MING HING BUILDING,

FUK WING STREET, SHAM SHUI PO, KOWLOON,

HONG KONG

[74] NG TSZ HONG

2/F, 174, MING HING BUILDING,

FUK WING STREET, SHAM SHUI PO, KOWLOON,

HONG KONG

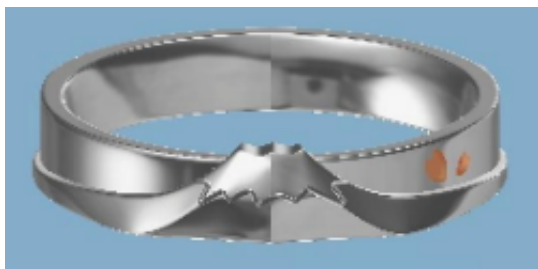

[11] 2423511.9M002

[15] 13-06-2024

[51] Cl. 11-01

[54] 戒指
Ring

[73] 吳子康

Ng Tsz Hong
2/F, 174, MING HING BUILDING,
FUK WING STREET, SHAM SHUI PO, KOWLOON,
HONG KONG

[74] NG TSZ HONG

2/F, 174, MING HING BUILDING,
FUK WING STREET, SHAM SHUI PO, KOWLOON,
HONG KONG



[11] 2423511.9M003

[15] 13-06-2024

[51] Cl. 11-01

[54] 戒指
Ring

[73] 吳子康

Ng Tsz Hong
2/F, 174, MING HING BUILDING,
FUK WING STREET, SHAM SHUI PO, KOWLOON,
HONG KONG

[74] NG TSZ HONG

2/F, 174, MING HING BUILDING,
FUK WING STREET, SHAM SHUI PO, KOWLOON,
HONG KONG



[11] 2423511.9M004

[15] 13-06-2024

[51] Cl. 11-01

[54] 戒指

Ring

[73] 吳子康

Ng Tsz Hong

2/F, 174, MING HING BUILDING,
FUK WING STREET, SHAM SHUI PO, KOWLOON,
HONG KONG

[74] NG TSZ HONG

2/F, 174, MING HING BUILDING,
FUK WING STREET, SHAM SHUI PO, KOWLOON,
HONG KONG



[11] 2423511.9M005

[15] 13-06-2024

[51] Cl. 11-01

[54] 戒指

Ring

[73] 吳子康

Ng Tsz Hong

2/F, 174, MING HING BUILDING,
FUK WING STREET, SHAM SHUI PO, KOWLOON,
HONG KONG

[74] NG TSZ HONG

2/F, 174, MING HING BUILDING,

FUK WING STREET, SHAM SHUI PO, KOWLOON,
HONG KONG



[11] 2423511.9M006

[15] 13-06-2024

[51] Cl. 11-01

[54] 戒指

Ring

[73] 吳子康

Ng Tsz Hong

2/F, 174, MING HING BUILDING,

FUK WING STREET, SHAM SHUI PO, KOWLOON,

HONG KONG

[74] NG TSZ HONG

2/F, 174, MING HING BUILDING,

FUK WING STREET, SHAM SHUI PO, KOWLOON,

HONG KONG



[11] 2423511.9M007

[15] 13-06-2024

[51] Cl. 11-01

[54] 戒指

Ring

[73] 吳子康

Ng Tsz Hong

2/F, 174, MING HING BUILDING,
FUK WING STREET, SHAM SHUI PO, KOWLOON,
HONG KONG

[74] NG TSZ HONG

2/F, 174, MING HING BUILDING,
FUK WING STREET, SHAM SHUI PO, KOWLOON,
HONG KONG



[11] 2423511.9M008

[15] 13-06-2024

[51] Cl. 11-01

[54] 戒指

Ring

[73] 吳子康

Ng Tsz Hong

2/F, 174, MING HING BUILDING,
FUK WING STREET, SHAM SHUI PO, KOWLOON,
HONG KONG

[74] NG TSZ HONG

2/F, 174, MING HING BUILDING,
FUK WING STREET, SHAM SHUI PO, KOWLOON,
HONG KONG



[11] 2423511.9M009

[15] 13-06-2024

[51] Cl. 11-01

[54] 戒指

Ring

[73] 吳子康

Ng Tsz Hong

2/F, 174, MING HING BUILDING,
FUK WING STREET, SHAM SHUI PO, KOWLOON,
HONG KONG

[74] NG TSZ HONG

2/F, 174, MING HING BUILDING,
FUK WING STREET, SHAM SHUI PO, KOWLOON,
HONG KONG



[11] 2423511.9M010

[15] 13-06-2024

[51] Cl. 11-01

[54] 戒指

Ring

[73] 吳子康

Ng Tsz Hong

2/F, 174, MING HING BUILDING,
FUK WING STREET, SHAM SHUI PO, KOWLOON,
HONG KONG

[74] NG TSZ HONG

2/F, 174, MING HING BUILDING,
FUK WING STREET, SHAM SHUI PO, KOWLOON,
HONG KONG



[11] 2423511.9M011

[15] 13-06-2024

[51] Cl. 11-01

[54] 戒指

Ring

[73] 吳子康

Ng Tsz Hong

2/F, 174, MING HING BUILDING,
FUK WING STREET, SHAM SHUI PO, KOWLOON,
HONG KONG

[74] NG TSZ HONG

2/F, 174, MING HING BUILDING,
FUK WING STREET, SHAM SHUI PO, KOWLOON,
HONG KONG

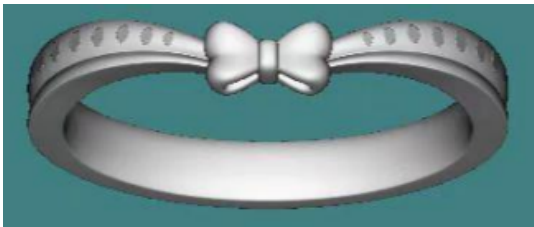

[11] 2423511.9M012

[15] 13-06-2024

[51] Cl. 11-01

[54] 戒指

Ring

[73] 吳子康

Ng Tsz Hong

2/F, 174, MING HING BUILDING,
FUK WING STREET, SHAM SHUI PO, KOWLOON,
HONG KONG

[74] NG TSZ HONG

2/F, 174, MING HING BUILDING,
FUK WING STREET, SHAM SHUI PO, KOWLOON,
HONG KONG



[11] 2423511.9M013

[15] 13-06-2024

[51] Cl. 11-01

[54] 戒指

Ring

[73] 吳子康

Ng Tsz Hong

2/F, 174, MING HING BUILDING,
FUK WING STREET, SHAM SHUI PO, KOWLOON,
HONG KONG

[74] NG TSZ HONG

2/F, 174, MING HING BUILDING,
FUK WING STREET, SHAM SHUI PO, KOWLOON,
HONG KONG

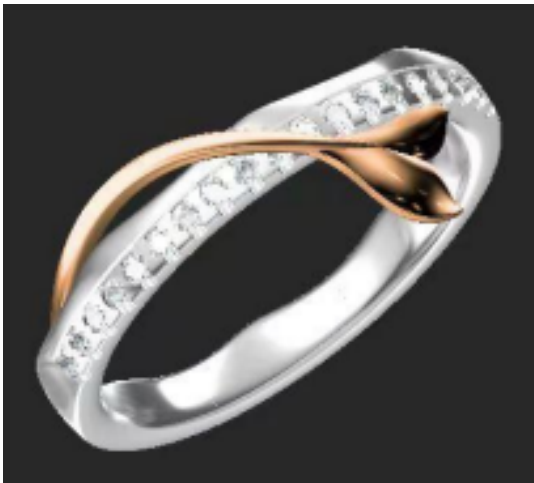

[11] 2423511.9M014

[15] 13-06-2024

[51] Cl. 11-01

[54] 戒指

Ring

[73] 吳子康

Ng Tsz Hong

2/F, 174, MING HING BUILDING,
FUK WING STREET, SHAM SHUI PO, KOWLOON,
HONG KONG

[74] NG TSZ HONG

2/F, 174, MING HING BUILDING,
FUK WING STREET, SHAM SHUI PO, KOWLOON,
HONG KONG

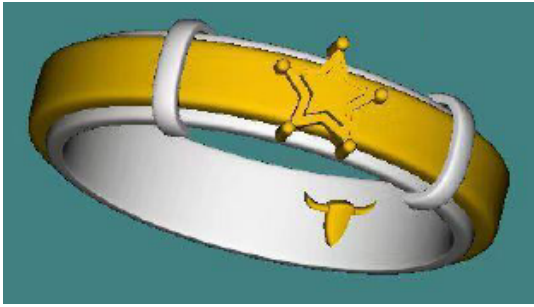

[11] 2423511.9M015

[15] 13-06-2024

[51] Cl. 11-01

[54] 戒指

Ring

[73] 吳子康

Ng Tsz Hong

2/F, 174, MING HING BUILDING,
FUK WING STREET, SHAM SHUI PO, KOWLOON,
HONG KONG

[74] NG TSZ HONG

2/F, 174, MING HING BUILDING,
FUK WING STREET, SHAM SHUI PO, KOWLOON,
HONG KONG

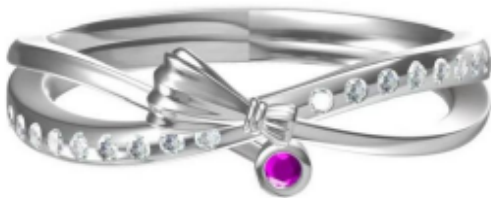

[11] 2423511.9M016

[15] 13-06-2024

[51] Cl. 11-01

[54] 戒指

Ring

[73] 吳子康

Ng Tsz Hong

2/F, 174, MING HING BUILDING,
FUK WING STREET, SHAM SHUI PO, KOWLOON,
HONG KONG

[74] NG TSZ HONG

2/F, 174, MING HING BUILDING,

FUK WING STREET, SHAM SHUI PO, KOWLOON,
HONG KONG



[11] 2423511.9M017

[15] 13-06-2024

[51] Cl. 11-01

[54] 戒指
Ring

[73] 吳子康

Ng Tsz Hong

2/F, 174, MING HING BUILDING,

FUK WING STREET, SHAM SHUI PO, KOWLOON,
HONG KONG

[74] NG TSZ HONG

2/F, 174, MING HING BUILDING,

FUK WING STREET, SHAM SHUI PO, KOWLOON,
HONG KONG



[11] 2423511.9M018

[15] 13-06-2024

[51] Cl. 11-01

[54] 戒指
Ring

[73] 吳子康

Ng Tsz Hong
2/F, 174, MING HING BUILDING,
FUK WING STREET, SHAM SHUI PO, KOWLOON,
HONG KONG

[74] NG TSZ HONG

2/F, 174, MING HING BUILDING,
FUK WING STREET, SHAM SHUI PO, KOWLOON,
HONG KONG



[11] 2423511.9M019

[15] 13-06-2024

[51] Cl. 11-01

[54] 戒指

Ring

[73] 吳子康

Ng Tsz Hong
2/F, 174, MING HING BUILDING,
FUK WING STREET, SHAM SHUI PO, KOWLOON,
HONG KONG

[74] NG TSZ HONG

2/F, 174, MING HING BUILDING,
FUK WING STREET, SHAM SHUI PO, KOWLOON,
HONG KONG



[11] 2423511.9M020

[15] 13-06-2024

[51] Cl. 11-01

[54] 戒指

Ring

[73] 吳子康

Ng Tsz Hong
2/F, 174, MING HING BUILDING,
FUK WING STREET, SHAM SHUI PO, KOWLOON,
HONG KONG

[74] NG TSZ HONG

2/F, 174, MING HING BUILDING,
FUK WING STREET, SHAM SHUI PO, KOWLOON,
HONG KONG



[11] 2423511.9M021

[15] 13-06-2024

[51] Cl. 11-01

[54] 戒指

Ring

[73] 吳子康

Ng Tsz Hong
2/F, 174, MING HING BUILDING,
FUK WING STREET, SHAM SHUI PO, KOWLOON,
HONG KONG

[74] NG TSZ HONG

2/F, 174, MING HING BUILDING,
FUK WING STREET, SHAM SHUI PO, KOWLOON,
HONG KONG



[11] 2423511.9M022

[15] 13-06-2024

[51] Cl. 11-01

[54] 戒指

Ring

[73] 吳子康

Ng Tsz Hong
2/F, 174, MING HING BUILDING,
FUK WING STREET, SHAM SHUI PO, KOWLOON,
HONG KONG

[74] NG TSZ HONG

2/F, 174, MING HING BUILDING,
FUK WING STREET, SHAM SHUI PO, KOWLOON,
HONG KONG



[11] 2423511.9M023

[15] 13-06-2024

[51] Cl. 11-01

[54] 戒指

Ring

[73] 吳子康

Ng Tsz Hong
2/F, 174, MING HING BUILDING,
FUK WING STREET, SHAM SHUI PO, KOWLOON,
HONG KONG

[74] NG TSZ HONG

2/F, 174, MING HING BUILDING,
FUK WING STREET, SHAM SHUI PO, KOWLOON,
HONG KONG



[11] 2423511.9M024

[15] 13-06-2024

[51] Cl. 11-01

[54] 戒指
Ring

[73] 吳子康
Ng Tsz Hong
2/F, 174, MING HING BUILDING,
FUK WING STREET, SHAM SHUI PO, KOWLOON,
HONG KONG

[74] NG TSZ HONG
2/F, 174, MING HING BUILDING,
FUK WING STREET, SHAM SHUI PO, KOWLOON,
HONG KONG



[11] 2423511.9M025

[15] 13-06-2024

[51] Cl. 11-01

[54] 戒指
Ring

[73] 吳子康

Ng Tsz Hong
2/F, 174, MING HING BUILDING,
FUK WING STREET, SHAM SHUI PO, KOWLOON,
HONG KONG

[74] NG TSZ HONG

2/F, 174, MING HING BUILDING,
FUK WING STREET, SHAM SHUI PO, KOWLOON,
HONG KONG



[11] 2423511.9M026

[15] 13-06-2024

[51] Cl. 11-01

[54] 戒指
Ring

[73] 吳子康

Ng Tsz Hong
2/F, 174, MING HING BUILDING,
FUK WING STREET, SHAM SHUI PO, KOWLOON,
HONG KONG

[74] NG TSZ HONG

2/F, 174, MING HING BUILDING,
FUK WING STREET, SHAM SHUI PO, KOWLOON,
HONG KONG

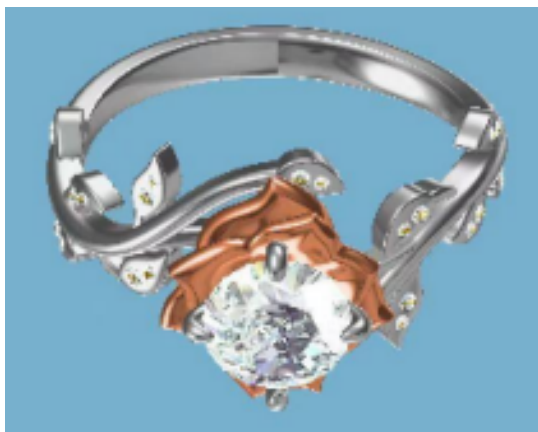

[11] 2423511.9M027

[15] 13-06-2024

[51] Cl. 11-01

[54] 戒指

Ring

[73] 吳子康

Ng Tsz Hong

2/F, 174, MING HING BUILDING,
FUK WING STREET, SHAM SHUI PO, KOWLOON,
HONG KONG

[74] NG TSZ HONG

2/F, 174, MING HING BUILDING,
FUK WING STREET, SHAM SHUI PO, KOWLOON,
HONG KONG

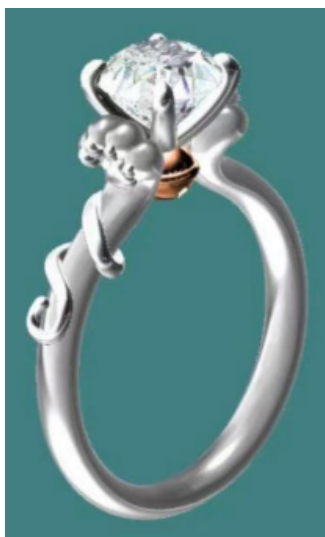

[11] 2423511.9M028

[15] 13-06-2024

[51] Cl. 11-01

[54] 戒指
Ring

[73] 吳子康
Ng Tsz Hong
2/F, 174, MING HING BUILDING,
FUK WING STREET, SHAM SHUI PO, KOWLOON,
HONG KONG

[74] NG TSZ HONG
2/F, 174, MING HING BUILDING,
FUK WING STREET, SHAM SHUI PO, KOWLOON,
HONG KONG



[11] 2423511.9M029

[15] 13-06-2024

[51] Cl. 11-01

[54] 戒指
Ring

[73] 吳子康
Ng Tsz Hong
2/F, 174, MING HING BUILDING,
FUK WING STREET, SHAM SHUI PO, KOWLOON,
HONG KONG

[74] NG TSZ HONG
2/F, 174, MING HING BUILDING,
FUK WING STREET, SHAM SHUI PO, KOWLOON,
HONG KONG



[11] 2423511.9M030

[15] 13-06-2024

[51] Cl. 11-01

[54] 戒指
Ring

[73] 吳子康
Ng Tsz Hong
2/F, 174, MING HING BUILDING,
FUK WING STREET, SHAM SHUI PO, KOWLOON,
HONG KONG

[74] NG TSZ HONG
2/F, 174, MING HING BUILDING,
FUK WING STREET, SHAM SHUI PO, KOWLOON,
HONG KONG



[11] 2423511.9M031

[15] 13-06-2024

[51] Cl. 11-01

[54] 戒指
Ring

[73] 吳子康
Ng Tsz Hong
2/F, 174, MING HING BUILDING,
FUK WING STREET, SHAM SHUI PO, KOWLOON,
HONG KONG

[74] NG TSZ HONG
2/F, 174, MING HING BUILDING,
FUK WING STREET, SHAM SHUI PO, KOWLOON,
HONG KONG



[11] 2423511.9M032

[15] 13-06-2024

[51] Cl. 11-01

[54] 戒指
Ring

[73] 吳子康

Ng Tsz Hong
2/F, 174, MING HING BUILDING,
FUK WING STREET, SHAM SHUI PO, KOWLOON,
HONG KONG

[74] NG TSZ HONG

2/F, 174, MING HING BUILDING,
FUK WING STREET, SHAM SHUI PO, KOWLOON,
HONG KONG



[11] 2423511.9M033

[15] 13-06-2024

[51] Cl. 11-01

[54] 戒指
Ring

[73] 吳子康

Ng Tsz Hong
2/F, 174, MING HING BUILDING,
FUK WING STREET, SHAM SHUI PO, KOWLOON,
HONG KONG

[74] NG TSZ HONG

2/F, 174, MING HING BUILDING,
FUK WING STREET, SHAM SHUI PO, KOWLOON,
HONG KONG



[11] 2423511.9M034

[15] 13-06-2024

[51] Cl. 11-01

[54] 戒指

Ring

[73] 吳子康

Ng Tsz Hong

2/F, 174, MING HING BUILDING,
FUK WING STREET, SHAM SHUI PO, KOWLOON,
HONG KONG

[74] NG TSZ HONG

2/F, 174, MING HING BUILDING,
FUK WING STREET, SHAM SHUI PO, KOWLOON,
HONG KONG



[11] 2423511.9M035

[15] 13-06-2024

[51] Cl. 11-01

[54] 戒指

Ring

[73] 吳子康

Ng Tsz Hong

2/F, 174, MING HING BUILDING,
FUK WING STREET, SHAM SHUI PO, KOWLOON,
HONG KONG

[74] NG TSZ HONG

2/F, 174, MING HING BUILDING,
FUK WING STREET, SHAM SHUI PO, KOWLOON,
HONG KONG



[11] 2423511.9M036

[15] 13-06-2024

[51] Cl. 11-01

[54] 戒指
Ring

[73] 吳子康

Ng Tsz Hong
2/F, 174, MING HING BUILDING,
FUK WING STREET, SHAM SHUI PO, KOWLOON,
HONG KONG

[74] NG TSZ HONG

2/F, 174, MING HING BUILDING,
FUK WING STREET, SHAM SHUI PO, KOWLOON,
HONG KONG



[11] 2423511.9M037

[15] 13-06-2024

[51] Cl. 11-01

[54] 戒指
Ring

[73] 吳子康

Ng Tsz Hong
2/F, 174, MING HING BUILDING,
FUK WING STREET, SHAM SHUI PO, KOWLOON,
HONG KONG

[74] NG TSZ HONG
2/F, 174, MING HING BUILDING,
FUK WING STREET, SHAM SHUI PO, KOWLOON,
HONG KONG



[11] 2423511.9M038

[15] 13-06-2024

[51] Cl. 11-01

[54] 戒指
Ring

[73] 吳子康

Ng Tsz Hong
2/F, 174, MING HING BUILDING,
FUK WING STREET, SHAM SHUI PO, KOWLOON,
HONG KONG

[74] NG TSZ HONG
2/F, 174, MING HING BUILDING,
FUK WING STREET, SHAM SHUI PO, KOWLOON,
HONG KONG

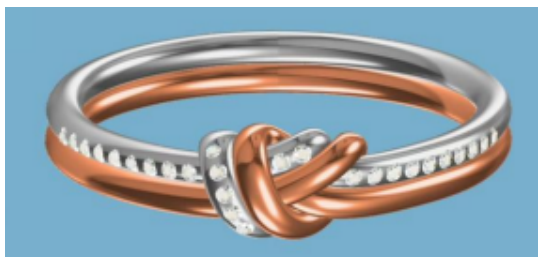

[11] 2423511.9M039

[15] 13-06-2024

[51] Cl. 11-01

[54] 戒指
Ring

[73] 吳子康

Ng Tsz Hong
2/F, 174, MING HING BUILDING,

FUK WING STREET, SHAM SHUI PO, KOWLOON,
HONG KONG

[74] NG TSZ HONG
2/F, 174, MING HING BUILDING,
FUK WING STREET, SHAM SHUI PO, KOWLOON,
HONG KONG



[11] 2423511.9M040

[15] 13-06-2024

[51] Cl. 11-01

[54] 戒指
Ring

[73] 吳子康
Ng Tsz Hong
2/F, 174, MING HING BUILDING,
FUK WING STREET, SHAM SHUI PO, KOWLOON,
HONG KONG

[74] NG TSZ HONG
2/F, 174, MING HING BUILDING,
FUK WING STREET, SHAM SHUI PO, KOWLOON,
HONG KONG



[11] 2423511.9M041

[15] 13-06-2024

[51] Cl. 11-01

[54] 戒指
Ring

[73] 吳子康
Ng Tsz Hong
2/F, 174, MING HING BUILDING,
FUK WING STREET, SHAM SHUI PO, KOWLOON,
HONG KONG

[74] NG TSZ HONG
2/F, 174, MING HING BUILDING,
FUK WING STREET, SHAM SHUI PO, KOWLOON,
HONG KONG



[11] 2423511.9M042

[15] 13-06-2024

[51] Cl. 11-01

[54] 戒指
Ring

[73] 吳子康
Ng Tsz Hong
2/F, 174, MING HING BUILDING,
FUK WING STREET, SHAM SHUI PO, KOWLOON,
HONG KONG

[74] NG TSZ HONG
2/F, 174, MING HING BUILDING,
FUK WING STREET, SHAM SHUI PO, KOWLOON,
HONG KONG

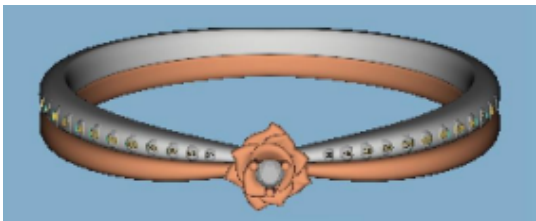

[11] 2423511.9M043

[15] 13-06-2024

[51] Cl. 11-01

[54] 戒指
Ring

[73] 吳子康
Ng Tsz Hong
2/F, 174, MING HING BUILDING,
FUK WING STREET, SHAM SHUI PO, KOWLOON,
HONG KONG

[74] NG TSZ HONG
2/F, 174, MING HING BUILDING,
FUK WING STREET, SHAM SHUI PO, KOWLOON,
HONG KONG



[11] 2423511.9M044

[15] 13-06-2024

[51] Cl. 11-01

[54] 戒指
Ring

[73] 吳子康
Ng Tsz Hong
2/F, 174, MING HING BUILDING,
FUK WING STREET, SHAM SHUI PO, KOWLOON,
HONG KONG

[74] NG TSZ HONG
2/F, 174, MING HING BUILDING,
FUK WING STREET, SHAM SHUI PO, KOWLOON,
HONG KONG

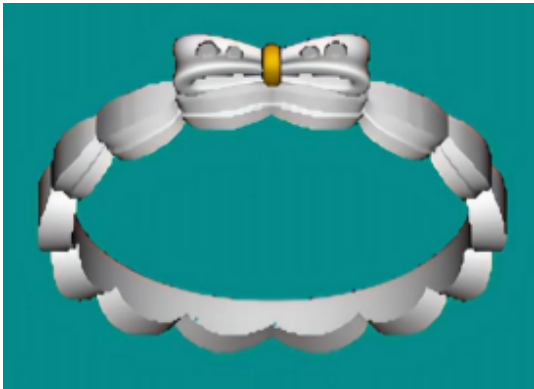

[11] 2423511.9M045

[15] 13-06-2024

[51] Cl. 11-01

[54] 戒指
Ring

[73] 吳子康
Ng Tsz Hong
2/F, 174, MING HING BUILDING,
FUK WING STREET, SHAM SHUI PO, KOWLOON,
HONG KONG

[74] NG TSZ HONG
2/F, 174, MING HING BUILDING,
FUK WING STREET, SHAM SHUI PO, KOWLOON,
HONG KONG



[11] 2423556.4

[15] 21-06-2024

[51] Cl. 23-01

[54] 浴缸水龍頭
Shower faucet

[73] 蔡茂雄

CHOI MOU HUNG

香港

粉嶺

坪洋村 DD79 HOUSE LOT127 號

[74] 蔡茂雄

香港

火炭禾寮坑路 2-16 號

安盛工業大廈 1 樓 B 室



[11] 2423577.8

[15] 27-06-2024

[51] Cl. 9-05

[54] 包裝編織袋
Packing woven bag

[73] 溢豐食品物流有限公司

YAT FUNG FOOD LOGISTIC COMPANY LIMITED

DD 23, LOT 627, LAI PEK SHAN SUN TSUEN,

SHUEN WAN, TAI PO,

HONG KONG

[74] YAT FUNG FOOD LOGISTIC COMPANY LIMITED

DD 23, LOT 627, LAI PEK SHAN SUN TSUEN,

TAI PO,

HONG KONG



[11] 2423583.0

[15] 24-06-2024

[51] Cl. 21-03

[54] 遊戲機

Gaming machine

[73] ATTA Technologies Limited

Unit 801, 8/F, Midas Plaza,
No.1 Tai Yau Street, San Po Kong,
Hong Kong

[74] REAL AND COMPLEX INTELLECTUAL PROPERTY SERVICES LIMITED

Flat C, 7/F, Kwai Bo Ind. Bldg.,
40 Wong Chuk Hang Road, Aberdeen,
Hong Kong

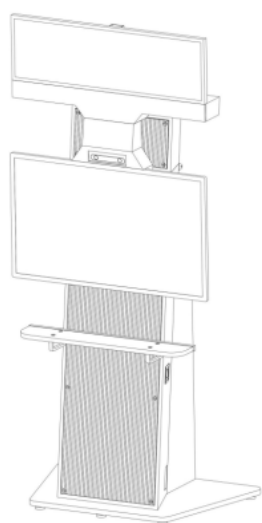

[11] 2423586.7

- [15] 25-06-2024
- [30] 08-01-2024 / CA, EG, AM, AZ, BZ, BA, GE, LI, MK, MD, MC, MN, ME, MA, NO, OM, RS, SG, CH, TN, TR, UA, GB, EU, AL, IL, KG / DM/235303
- [51] Cl. 10-02
- [54] 錶
Watch
- [73] BLANCPAIN SA
Le Rocher 12,
CH-1348 LE Brassus,
Switzerland
- [74] SPRUSON & FERGUSON (HONG KONG) LIMITED
5001 Hopewell Centre,
183 Queen's Road East, Wan Chai,
Hong Kong



-
- [11] 2423591.7
- [15] 26-06-2024
- [51] Cl. 9-01
- [54] 香水樽
Perfume bottle
- [73] 思飛國際有限公司
Assisi International Co. Limited
10/F, Kin Sang Commercial Centre,
49 King Yip Street, Kwun Tong, Kowloon,
Hong Kong
- [74] ACCOLADE IP LIMITED
10/F, Fu Fai Comm. Ctr.,
27 Hillier Street, Sheung Wan,
Hong Kong



[11] 2423592.9

[15] 26-06-2024

[51] Cl. 25-01

[54] 改造玻璃
Retrofit glass

[73] 广东南星玻璃有限公司
Guangdong South Star Glass Limited
中國
广东省佛山市三水区乐平镇
三水中心科技工业园拓业路 6 号

[74] 專利及設計有限公司
香港
屯門新安街 16 號
百勝工業大廈 2A1 樓 A20 室

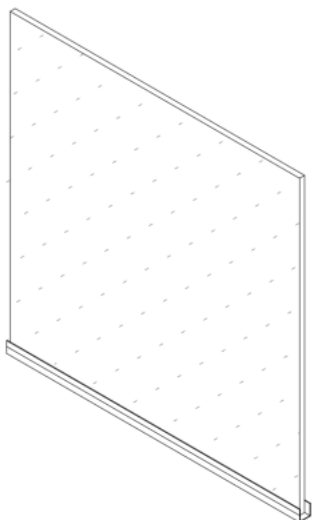

- [11] 2423593.1
[15] 26-06-2024
[51] Cl. 25-01
[54] 改造邊框
Retrofit frame
[73] 广东南星玻璃有限公司
Guangdong South Star Glass Limited
中國
广东省佛山市三水区乐平镇
三水中心科技工业园拓业路 6 号
[74] 專利及設計有限公司
香港
屯門新安街 16 號
百勝工業大廈 2A1 樓 A20 室

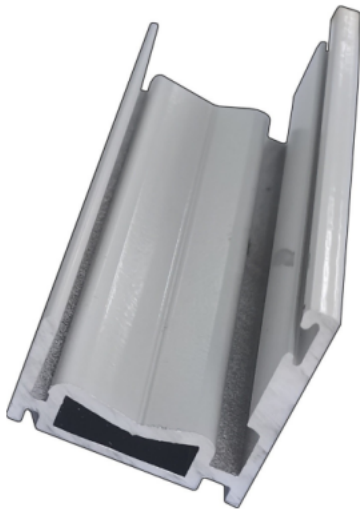

-
- [11] 2423597.0
[15] 26-03-2024
[30] 27-09-2023 / CN / 2023306345439
27-09-2023 / CN / 2023306345674
[51] Cl. 21-01
[54] 玩具(翼龍造型)
Toy (pterosaurs shape)
[73] 汕頭市兒超喜智能科技實業有限公司
中國
廣東省汕頭市澄海區廣益街道登峰路廣峰工業區 3 號
[74] 聚一知識產權有限公司
香港

九龍尖沙咀嘉蘭圍 5-11 號
利時商業大廈 1813 號



[11] 2423598.2

[15] 26-03-2024

[30] 27-09-2023 / CN / 2023306345797

27-09-2023 / CN / 2023306344991

[51] Cl. 21-01

[54] 玩具 (戰鬥機造型)

Toy (fighter shape)

[73] 汕頭市兒超喜智能科技實業有限公司

中國

廣東省汕頭市澄海區廣益街道登峰路廣峰工業區 3 號

[74] 聚一知識產權有限公司

香港

九龍尖沙咀嘉蘭圍 5-11 號

利時商業大廈 1813 號

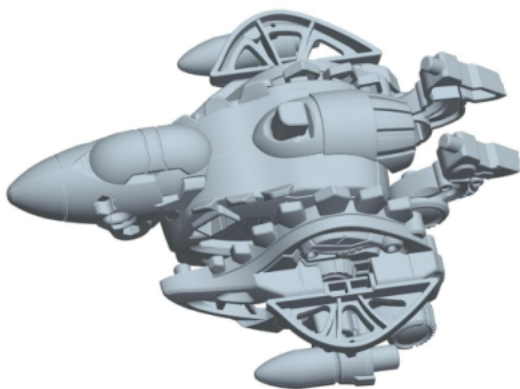

[11] 2423600.8M001

[15] 26-06-2024

[51] Cl. 19-08

[54] 包裝標籤

Packaging label

[73] 達江食品(香港)有限公司

Tat Kong Food (HK) Limited

香港

元朗喜業工廠大廈 4 樓 T9-10 室

[74] 卓遠知識產權有限公司

香港

上環禧利街 27 號

富輝商業中心 10 樓



[11] 2423600.8M002

[15] 26-06-2024

[51] Cl. 19-08

[54] 包裝標籤

Packaging label

[73] 達江食品(香港)有限公司

Tat Kong Food (HK) Limited

香港

元朗喜業工廠大廈 4 樓 T9-10 室

[74] 卓遠知識產權有限公司

香港

上環禧利街 27 號

富輝商業中心 10 樓



[11] 2423602.2

[15] 27-06-2024

[51] Cl. 9-02

[54] 包裝罐

Packing drum

[73] 溢豐食品物流有限公司

YAT FUNG FOOD LOGISTIC COMPANY LIMITED
DD 23, LOT 627, LAI PEK SHAN SUN TSUEN,
SHUEN WAN, TAI PO,
HONG KONG

[74] YAT FUNG FOOD LOGISTIC COMPANY LIMITED

DD 23, LOT 627, LAI PEK SHAN SUN TSUEN,
TAI PO,
HONG KONG



[11] 2423603.4

[15] 27-06-2024

[51] Cl. 9-02

[54] 包裝罐

Packing drum

[73] 溢豐食品物流有限公司

YAT FUNG FOOD LOGISTIC COMPANY LIMITED
DD 23, LOT 627, LAI PEK SHAN SUN TSUEN,
SHUEN WAN, TAI PO,
HONG KONG

[74] YAT FUNG FOOD LOGISTIC COMPANY LIMITED
DD 23, LOT 627, LAI PEK SHAN SUN TSUEN,
TAI PO,
HONG KONG



[11] 2423604.6

[15] 27-06-2024

[51] Cl. 9-02

[54] 包裝罐

Packing drum

[73] 溢豐食品物流有限公司

YAT FUNG FOOD LOGISTIC COMPANY LIMITED
DD 23, LOT 627, LAI PEK SHAN SUN TSUEN,
SHUEN WAN, TAI PO,
HONG KONG

[74] YAT FUNG FOOD LOGISTIC COMPANY LIMITED
DD 23, LOT 627, LAI PEK SHAN SUN TSUEN,
TAI PO,
HONG KONG



[11] 2423605.9

[15] 27-06-2024

[51] Cl. 9-02

[54] 包裝罐

Packing drum

[73] 溢豐食品物流有限公司

YAT FUNG FOOD LOGISTIC COMPANY LIMITED
DD 23, LOT 627, LAI PEK SHAN SUN TSUEN,
SHUEN WAN, TAI PO,
HONG KONG

[74] YAT FUNG FOOD LOGISTIC COMPANY LIMITED
DD 23, LOT 627, LAI PEK SHAN SUN TSUEN,
TAI PO,
HONG KONG



- [11] 2423607.3
[15] 27-06-2024
[30] 30-01-2024 / CA, MX, OM, SG, CH, TR, GB, EU, IL / DM/236045
[51] Cl. 10-02
[54] 錶
Watch
[73] RADO UHREN AG (RADO WATCH CO. LTD.) (MONTRES RADO SA)
Bielstrasse 45,
CH-2543 Lengnau,
Switzerland
[74] SPRUSON & FERGUSON (HONG KONG) LIMITED
5001 Hopewell Centre,
183 Queen's Road East, Wan Chai,
Hong Kong



-
- [11] 2423620.0
[15] 02-07-2024
[51] Cl. 9-02
[54] 包裝罐
Packing drum
[73] 溢豐食品物流有限公司
YAT FUNG FOOD LOGISTIC COMPANY LIMITED
DD 23, LOT 627, LAI PEK SHAN SUN TSUEN,
SHUEN WAN, TAI PO,
HONG KONG
[74] YAT FUNG FOOD LOGISTIC COMPANY LIMITED
DD 23, LOT 627, LAI PEK SHAN SUN TSUEN,
TAI PO,
HONG KONG



[11] 2423621.2

[15] 02-07-2024

[30] 02-01-2024 / CN / 2024300013896

[51] C1. 20-02

[54] 電子貨架標籤

Electronic shelf label

[73] 盒马(中国)有限公司

Hema (China) Co., Ltd.

中國

200131 上海市浦东新区中国(上海)自由贸易试验区

浦东大道1200号巨洋大厦2楼210室

[74] 三友知識產權代理有限公司

香港

德輔道中188號

金龍中心23樓2301室





香港特別行政區政府知識產權署外觀設計註冊處
The Government of the Hong Kong Special Administrative Region
Designs Registry, Intellectual Property Department

根據註冊外觀設計條例第 28 條，下列註冊外觀設計因未繳續期費而停止有效。

各組記項按註冊外觀設計停止有效日期及註冊編號先後次序排列。

Registered designs ceased through non-payment of renewal fees under section 28 of the Registered Designs Ordinance. Entries are listed below under their expiry dates.

11-07-2024 - 17-07-2024

11-07-2024	1914217.7	1914268.4
1914207.6M001	1914219.1M001	
1914207.6M002	1914219.1M002	17-07-2024
1914207.6M003	1914221.5	1401346.0
1914207.6M004	1914225.4	1401349.6
1914208.8M001	1914227.8M001	1401350.8
1914208.8M006	1914227.8M002	1401351.0M001
1914208.8M008	1914229.2M001	1401351.0M002
1914208.8M009	1914229.2M002	1401351.0M003
1914208.8M010	1914230.4M001	1401351.0M004
1914209.0M001	1914230.4M002	1401351.0M005
1914209.0M002	1914231.6M001	1401351.0M006
1914209.0M003	1914231.6M002	1914271.0
1914210.2		1914272.2
1914211.4	15-07-2024	1914273.4
1914212.6	1401330.6	1914275.9
	1401332.0	
12-07-2024	1914233.0	
0901099.8	1914234.2	
0901104.0M001	1914235.5M001	
0901104.0M002	1914235.5M002	
	1914235.5M003	
13-07-2024	1914235.5M004	
1401300.3M001	1914237.9	
1401300.3M002	1914239.3M001	
1401307.8	1914239.3M002	
1401308.0M001	1914239.3M003	
1401308.0M002	1914239.3M004	
1401308.0M003	1914243.1	
1500744.4		
	16-07-2024	
14-07-2024	1914261.9M001	
1401310.4	1914261.9M002	
1500658.2	1914262.1	



香港特別行政區政府知識產權署外觀設計註冊處

The Government of the Hong Kong Special Administrative Region

Designs Registry, Intellectual Property Department

根據註冊外觀設計規則第 31 條刪除的註冊外觀設計。各組記項按註冊外觀設計刪除日期及註冊編號先後次序排列。

Registered designs removed under section 31 of the Registered Designs Rules. Entries are listed below under their removal dates.

20-07-2024 - 25-07-2024

20-07-2024	1400093.1M003
1400066.5M003	1400093.1M004
1400066.5M004	
1400066.5M005	
1400068.9	
1400070.3	

24-07-2024

21-07-2024	1900100.3
0900055.5	1900101.5
0900060.5	1900102.7
1900089.8	1900103.9
1900090.0	1900104.1
1900091.2M001	1900105.4
1900091.2M002	1900106.6
	1900107.8
	1900108.0

22-07-2024

0900080.7M002	
1400082.8	
1900092.4M001	
1900092.4M003	
1900093.6M001	
1900093.6M003	
1900093.6M004	
1900094.8	
1900095.1	
1900096.3	

25-07-2024

23-07-2024

0410138.8	
1400085.5	
1400086.7	
1400088.1M001	
1400088.1M002	
1400088.1M003	