

香港知識產權公報

Hong Kong Intellectual Property Journal

2024年5月10日

10 May 2024



目錄 Contents

根據註冊外觀設計條例第 25 條註冊的外觀設計

Designs Registered under section 25 of the Registered Designs Ordinance

按註冊編號排列

Arranged by Registration Number

根據註冊外觀設計條例(第 522 章)公布的其他公告

Other Notices Published under the Registered Designs Ordinance (Cap. 522)

根據註冊外觀設計條例第 28 條，註冊外觀設計因未繳續期費而停止有效

Registered designs ceased through non-payment of renewal fees under section 28 of the Registered Designs Ordinance

根據註冊外觀設計規則第 31 條刪除的註冊外觀設計

Registered designs removed under section 31 of the Registered Designs Rules

根據註冊外觀設計條例第 76 條，更正已提交文件中的錯誤

Correction of errors in filed documents under section 76 of the Registered Designs Ordinance

以下事項沒有記錄

No Records for the Following Matters

根據註冊外觀設計條例第 30 條放棄的外觀設計的註冊

Surrender of Registration of Design under section 30 of the Registered Designs Ordinance

根據註冊外觀設計規則第 37 條，向處長作出轉介

Reference to Registrar under section 37 of the Registered Designs Rules

根據註冊外觀設計條例第 45 條，撤銷註冊

Revocation of Registration under section 45 of the Registered Designs Ordinance

根據註冊外觀設計規則第 46 條，向法院作出轉介

Reference to Court under section 46 of the Registered Designs Rules

根據註冊外觀設計規則第 63 條對不符合規定之處作出糾正

Rectification of Irregularities under section 63 of the Registered Designs Rules

根據註冊外觀設計條例第 66 條，糾正註冊紀錄冊

Rectification of Register under section 66 of the Registered Designs Ordinance

根據註冊外觀設計條例第 67 條 更正註冊紀錄冊內的錯誤

Correction of errors in Register under section 67 of the Registered Designs Ordinance

根據註冊外觀設計條例第 67 及 76 條，更正註冊紀錄冊內及已提交文件中的錯誤

Correction of Errors in Register and in Filed Documents under sections 67 and 76 of the Registered Designs Ordinance

勘誤

Corrigendum

註冊外觀設計公告註釋

Notes on advertisements of registration of designs

方括號表示下列資料：

Square brackets indicate the following data：

[11] 註冊編號 Registration number / 聯合王國註冊編號 United Kingdom registration number

[15] 註冊日期 Registration date / 當作註冊日期 Deemed registration date / 聯合王國註冊日期 United Kingdom registration date

[17] 註冊有效期屆滿日期 Expiry date of the period of registration

[22] 提交日期 Filing date / 當作提交日期 Deemed filing date / 聯合王國提交日期 United Kingdom filing date

[30] 聲稱享有的優先權（提交日期 / 巴黎公約國或世界貿易組織成員 / 申請編號） Priority claimed (filing date / Paris Convention country or WTO member / application number)

[51] 國際外觀設計分類號（洛迦諾分類號） International Classification of designs (Locarno Classification)

[54] 物品 Article

[55] 外觀設計的表述 Representation of the design

[62] 分開前的申請編號及提交日期 Application number before division and filing date

[66] 過往註冊的聯繫外觀設計註冊編號 / 日期 Registration No. / Date of Previous Registration for Association

[72] 設計人 Designer

[73] 擁有人姓名和地址 Name and address of the owner

[74] 代理人 Agent / 送達地址 Address for service



香港特別行政區政府知識產權署外觀設計註冊處

The Government of the Hong Kong Special Administrative Region

Designs Registry, Intellectual Property Department

根據註冊外觀設計條例第 25 條註冊的外觀設計

Designs registered under section 25 of the Registered Designs Ordinance

按註冊編號排列

Arranged by Registration Number

- [11] 2322118.3
- [15] 22-09-2023
- [30] 23-03-2023 / CH, GB, EU, JP, KR / WIPO130651
- [51] Cl. 11-01
- [54] 戒指
Ring
- [73] Cartier International AG
Hinterbergstrasse 22,
6312 Steinhausen,
Switzerland
- [74] DEACONS
5th Floor, Alexandra House,
Central,
Hong Kong

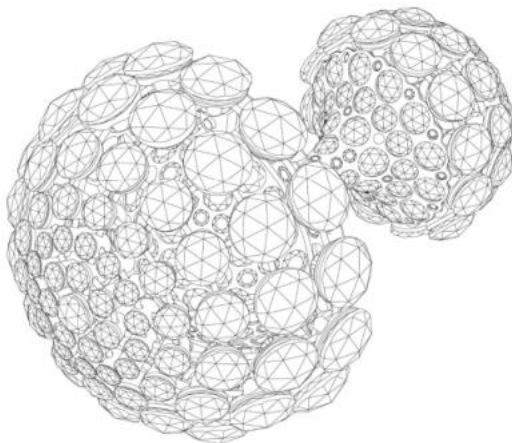

-
- [11] 2322143.5
 - [15] 27-09-2023
 - [30] 27-03-2023 / CH, GB, EU, JP, KR / WIPO130781
 - [51] Cl. 11-01

[54] 戒指
Ring

[73] Cartier International AG
Hinterbergstrasse 22,
6312 Steinhausen,
Switzerland

[74] DEACONS
5th Floor, Alexandra House,
Central,
Hong Kong



[11] 2322154.8

[15] 29-09-2023

[30] 29-03-2023 / CH, GB, EU, JP, KR / WIPO130909

[51] Cl. 11-01

[54] 手鐲
Bracelet

[73] Cartier International AG
Hinterbergstrasse 22,
6312 Steinhausen,
Switzerland

[74] DEACONS
5th Floor, Alexandra House,
Central,
Hong Kong



[11] 2322437.9M001

[15] 29-11-2023

[51] Cl. 12-08

[54] 汽車

Automobile

[73] Dr. Ing. h.c. F. Porsche Aktiengesellschaft

Porscheplatz 1,
70435 Stuttgart,
Germany

[74] WENPING PATENT & TRADE MARK AGENT LIMITED

1701 Tung Wai Commercial Building,
111 Gloucester Road,
Hong Kong



[11] 2322437.9M002

[15] 29-11-2023

[51] Cl. 12-08

[54] 汽車

Automobile

[73] Dr. Ing. h.c. F. Porsche Aktiengesellschaft
Porscheplatz 1,
70435 Stuttgart,
Germany

[74] WENPING PATENT & TRADE MARK AGENT LIMITED
1701 Tung Wai Commercial Building,
111 Gloucester Road,
Hong Kong



[11] 2322437.9M003

[15] 29-11-2023

[51] Cl. 12-16

[54] 汽車前面板
Front panel for vehicles

[73] Dr. Ing. h.c. F. Porsche Aktiengesellschaft
Porscheplatz 1,
70435 Stuttgart,
Germany

[74] WENPING PATENT & TRADE MARK AGENT LIMITED
1701 Tung Wai Commercial Building,
111 Gloucester Road,
Hong Kong



[11] 2322437.9M004

[15] 29-11-2023

[51] Cl. 12-16

[54] 汽車擾流板
Spoiler for vehicles

[73] Dr. Ing. h.c. F. Porsche Aktiengesellschaft
Porscheplatz 1,
70435 Stuttgart,
Germany

[74] WENPING PATENT & TRADE MARK AGENT LIMITED
1701 Tung Wai Commercial Building,
111 Gloucester Road,
Hong Kong



[11] 2322437.9M005

[15] 29-11-2023

[51] Cl. 12-16

[54] 汽車擾流板
Spoiler for vehicles

[73] Dr. Ing. h.c. F. Porsche Aktiengesellschaft
Porscheplatz 1,
70435 Stuttgart,
Germany

[74] WENPING PATENT & TRADE MARK AGENT LIMITED
1701 Tung Wai Commercial Building,
111 Gloucester Road,
Hong Kong

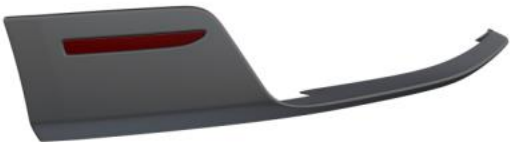

[11] 2322437.9M006

[15] 29-11-2023

[51] Cl. 12-16

[54] 汽車擋泥板
Fender for vehicles

[73] Dr. Ing. h.c. F. Porsche Aktiengesellschaft
Porscheplatz 1,
70435 Stuttgart,
Germany

[74] WENPING PATENT & TRADE MARK AGENT LIMITED
1701 Tung Wai Commercial Building,
111 Gloucester Road,
Hong Kong



[11] 2322437.9M007

[15] 29-11-2023

[51] Cl. 12-16

[54] 汽車擋泥板
Fender for vehicles

[73] Dr. Ing. h.c. F. Porsche Aktiengesellschaft
Porscheplatz 1,
70435 Stuttgart,
Germany

[74] WENPING PATENT & TRADE MARK AGENT LIMITED
1701 Tung Wai Commercial Building,
111 Gloucester Road,
Hong Kong



[11] 2322437.9M008

[15] 29-11-2023

[51] Cl. 12-16

[54] 汽車車身板
Vehicle body panel

[73] Dr. Ing. h.c. F. Porsche Aktiengesellschaft
Porscheplatz 1,
70435 Stuttgart,
Germany

[74] WENPING PATENT & TRADE MARK AGENT LIMITED
1701 Tung Wai Commercial Building,
111 Gloucester Road,
Hong Kong



[11] 2322437.9M009

[15] 29-11-2023

[51] Cl. 12-16

[54] 一部分的汽車擾流板
Part of spoiler for vehicles

[73] Dr. Ing. h.c. F. Porsche Aktiengesellschaft
Porscheplatz 1,
70435 Stuttgart,
Germany

[74] WENPING PATENT & TRADE MARK AGENT LIMITED
1701 Tung Wai Commercial Building,
111 Gloucester Road,
Hong Kong



[11] 2322437.9M010

[15] 29-11-2023

[51] Cl. 12-16

[54] 一部分的汽車擾流板
Part of spoiler for vehicles

[73] Dr. Ing. h.c. F. Porsche Aktiengesellschaft
Porscheplatz 1,
70435 Stuttgart,
Germany

[74] WENPING PATENT & TRADE MARK AGENT LIMITED
1701 Tung Wai Commercial Building,

111 Gloucester Road,
Hong Kong



[11] 2322437.9M011

[15] 29-11-2023

[51] Cl. 12-16

[54] 汽車擾流板

Spoiler for vehicles

[73] Dr. Ing. h.c. F. Porsche Aktiengesellschaft

Porscheplatz 1,
70435 Stuttgart,
Germany

[74] WENPING PATENT & TRADE MARK AGENT LIMITED

1701 Tung Wai Commercial Building,
111 Gloucester Road,
Hong Kong



[11] 2322437.9M012

[15] 29-11-2023

[51] Cl. 12-16

[54] 汽車擾流板

Spoiler for vehicles

[73] Dr. Ing. h.c. F. Porsche Aktiengesellschaft
Porscheplatz 1,
70435 Stuttgart,
Germany

[74] WENPING PATENT & TRADE MARK AGENT LIMITED
1701 Tung Wai Commercial Building,
111 Gloucester Road,
Hong Kong



[11] 2322607.1

[15] 29-12-2023

[51] Cl. 7-04

[54] 手持式可換刀片蔬果螺旋切絲/切片器
Handheld veg and fruits spiralizer with inter-changeable
blades

[73] 利源家庭用品有限公司
LEE YUEN HOUSEWARES CO., LTD.
Unit G, 12/F., World Tech Centre,
95 How Ming Street,
Kwun Tong, Kowloon, Hong Kong

[74] CHAN, TANG & KWOK
Rooms 2503-4, 25/F,
Shanghai Industrial Investment Building,
48-62 Hennessy Road, Wanchai, Hong Kong



[11] 2422641.3

[15] 10-01-2024

[51] Cl. 9-07

[54] 包裝容器用噴嘴

Nozzle for packaging container

[73] 樂敦製藥株式會社

Rohto Pharmaceutical Co., Ltd.

8-1, Tatsuminishi 1-chome Ikuno-ku,

Osaka-shi, Osaka,

Japan

[74] MARKS & CLERK

Level 9, Cyberport 1,

100 Cyberport Road,

Pok Fu Lam, Hong Kong

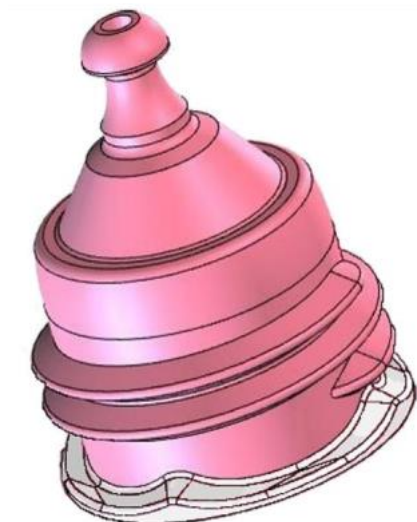

[11] 2422664.1

[15] 11-01-2024

[30] 02-08-2023 / KR / 30-2023-0030164

[51] Cl. 7-05

[54] 熨斗

Iron

[73] LG Jeon za Joo-sik-hoi-sa (LG Electronics Inc.)

128, Yeoui-daero,

Yeongdeungpo-gu, Seoul, 07336,

Republic of Korea

[74] SPRUSON & FERGUSON (HONG KONG) LIMITED

5001 Hopewell Centre,

183 Queen's Road East,
Wan Chai, Hong Kong

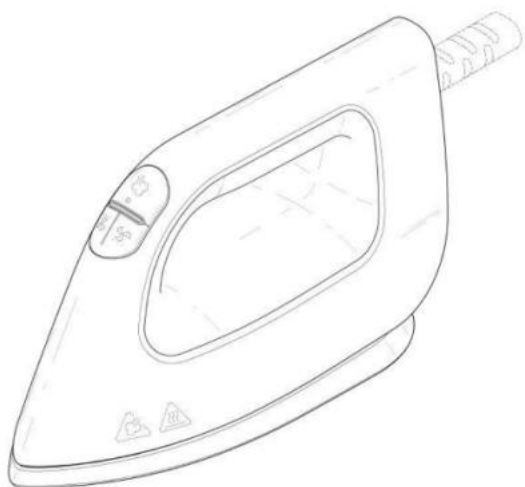

[11] 2422718.7

[15] 22-01-2024

[51] Cl. 13-02

[54] 磁吸無線充電器
Magnetic wireless charger

[73] 深圳市酷啦科技有限公司
中國廣東省深圳市
龍華區福城街道茜坑社區
鴻創科技中心 6 棟 1001

[74] 旻貝國際知識產權代理有限公司
香港新界白石角
香港科學園第三期
科技大道西 12 號 2 樓 230 室



[11] 2422779.5

[15] 02-02-2024

[30] 15-08-2023 / DE / 40 2023 100 563.9

[51] Cl. 21-01

[54] 玩具車

Toy vehicle

[73] VOLKSWAGEN AKTIENGESELLSCHAFT

Berliner Ring 2,

38440 Wolfsburg,

Germany

[74] CHINA PATENT AGENT (HONG KONG) LIMITED

22/F, Great Eagle Centre,

23 Harbour Road,

Wanchai, Hong Kong



[11] 2422782.1

[15] 02-02-2024

[30] 16-08-2023 / US / 29/910,146

[51] Cl. 9-03

[54] 容器

Container

[73] Merrilee Kick

2114 McDaniel Drive,

Carrollton, TX 75006,

United States of America

[74] LIU, SHEN & ASSOCIATES

Room 3716, 37/F, Sun Hung Kai Centre,

30 Harbour Road,

Wanchai, Hong Kong

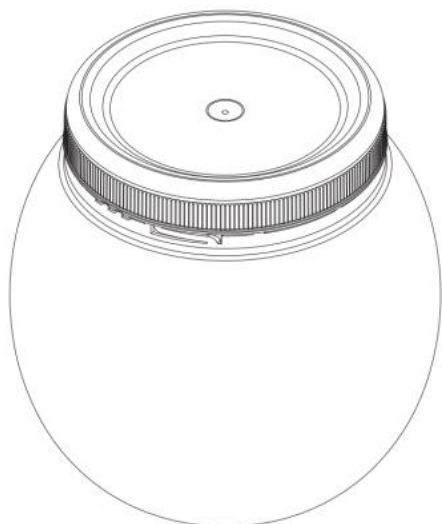

[11] 2422791.0M001

[15] 05-02-2024

[30] 05-08-2023 / US / 29/899,170

[51] Cl. 14-06

[54] 耳機支架

Earpiece holder

[73] 德茨布斯公司

Decibullz LLC

4103 S Mason, Unit A,

Fort Collins CO 80525,

United States of America

[74] WENPING PATENT & TRADE MARK AGENT LIMITED

1701 Tung Wai Commercial Building,

111 Gloucester Road,

Hong Kong

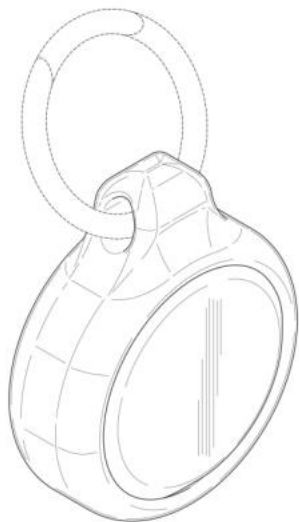

[11] 2422791.0M002

[15] 05-02-2024

[30] 05-08-2023 / US / 29/899,170

[51] Cl. 14-06

[54] 耳機支架

Earpiece holder

[73] 德茨布斯公司

Decibullz LLC

4103 S Mason, Unit A,

Fort Collins CO 80525,

United States of America

[74] WENPING PATENT & TRADE MARK AGENT LIMITED

1701 Tung Wai Commercial Building,

111 Gloucester Road,

Hong Kong



[11] 2422791.0M003

[15] 05-02-2024

[30] 05-08-2023 / US / 29/899,170

[51] Cl. 14-06

[54] 耳機支架

Earpiece holder

[73] 德茨布斯公司

Decibullz LLC

4103 S Mason, Unit A,

Fort Collins CO 80525,

United States of America

[74] WENPING PATENT & TRADE MARK AGENT LIMITED

1701 Tung Wai Commercial Building,

111 Gloucester Road,
Hong Kong

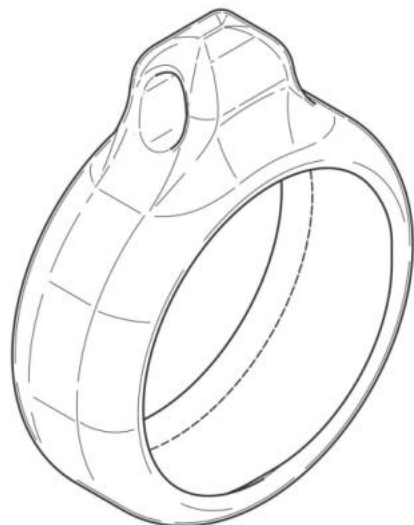

[11] 2422791.0M004

[15] 05-02-2024

[30] 05-08-2023 / US / 29/899,170

[51] Cl. 14-06

[54] 耳機支架
Earpiece holder

[73] 德茨布斯公司
Decibullz LLC
4103 S Mason, Unit A,
Fort Collins CO 80525,
United States of America

[74] WENPING PATENT & TRADE MARK AGENT LIMITED
1701 Tung Wai Commercial Building,
111 Gloucester Road,
Hong Kong

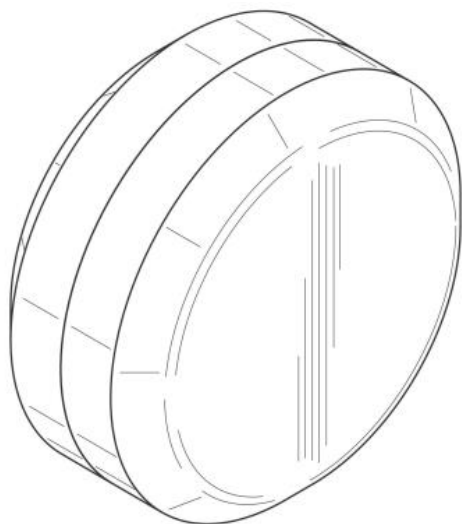

[11] 2422791.0M005

[15] 05-02-2024

[30] 05-08-2023 / US / 29/899,170

[51] Cl. 14-06

[54] 耳機支架

Earpiece holder

[73] 德茨布斯公司

Decibullz LLC

4103 S Mason, Unit A,

Fort Collins CO 80525,

United States of America

[74] WENPING PATENT & TRADE MARK AGENT LIMITED

1701 Tung Wai Commercial Building,

111 Gloucester Road,

Hong Kong

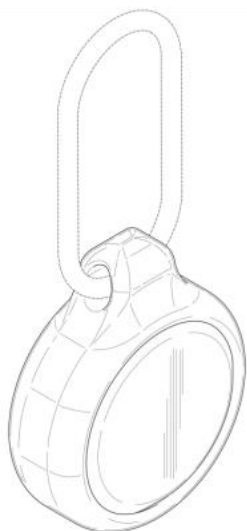

[11] 2422820.3

[15] 16-02-2024

[30] 18-08-2023 / US / 29/900,311

[51] Cl. 11-01

[54] 珠寶

Jewellery

[73] Raye Rocks LLC

2600 S Douglas Rd, Ste 1008,

Coral Gables, FL 33134,

United States of America

[74] LETTERS & THOO LIMITED

Suite 1001-1003, 10/F, Prosperity Millennia Plaza,

663 King's Road,

Quarry Bay, Hong Kong

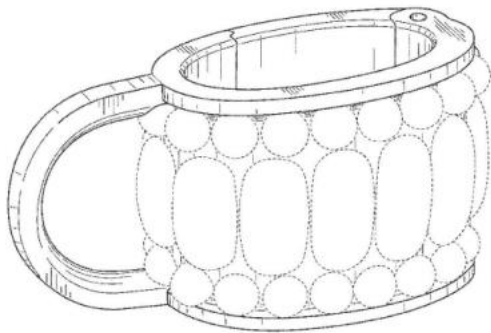

[11] 2422829.2

[15] 20-02-2024

[30] 21-08-2023 / KR / 30-2023-0032366

[51] Cl. 13-02

[54] 皮膚美容儀的充電器

Charger of skin esthetic apparatus

[73] 愛普兒株式會社

APR Co., Ltd.

36F,

300, Olympic-ro, Songpa-gu, Seoul,

Republic of Korea

[74] WANG WENKUI

Flat H, 16/F, Block 7,

Lily Mansions, Whampoa Garden,

Hung Hom, Kowloon, Hong Kong



[11] 2422900.3M001

[15] 12-11-2022

[51] Cl. 24-02

[54] 藥物輸送裝置

Medication delivery device

[73] ELI LILLY AND COMPANY

P.O. Box 6288,

Indianapolis, IN 46206-6288,

United States of America

[74] MARKS & CLERK

Level 9, Cyberport 1,

100 Cyberport Road,

Pok Fu Lam, Hong Kong

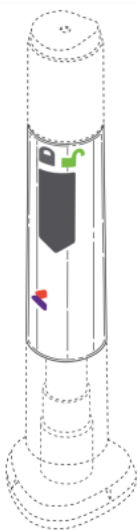

[11] 2422900.3M002

[15] 12-11-2022

[51] Cl. 24-02

[54] 藥物輸送裝置

Medication delivery device

[73] ELI LILLY AND COMPANY

P.O. Box 6288,

Indianapolis, IN 46206-6288,

United States of America

[74] MARKS & CLERK

Level 9, Cyberport 1,

100 Cyberport Road,

Pok Fu Lam, Hong Kong

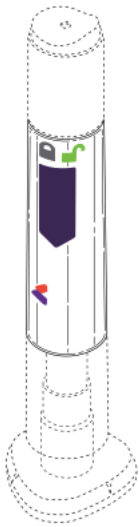

[11] 2422900.3M003

[15] 12-11-2022

[51] Cl. 24-02

[54] 藥物輸送裝置

Medication delivery device

[73] ELI LILLY AND COMPANY

P.O. Box 6288,

Indianapolis, IN 46206-6288,

United States of America

[74] MARKS & CLERK

Level 9, Cyberport 1,

100 Cyberport Road,

Pok Fu Lam, Hong Kong

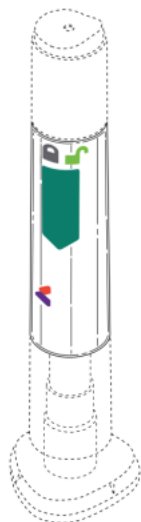

[11] 2422900.3M004

[15] 12-11-2022

[51] Cl. 24-02

[54] 藥物輸送裝置

Medication delivery device

[73] ELI LILLY AND COMPANY

P.O. Box 6288,

Indianapolis, IN 46206-6288,

United States of America

[74] MARKS & CLERK

Level 9, Cyberport 1,

100 Cyberport Road,

Pok Fu Lam, Hong Kong

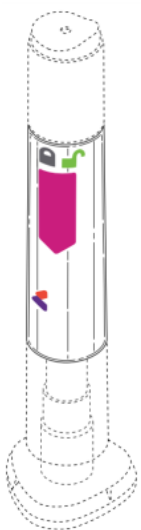

[11] 2422900.3M005

[15] 12-11-2022

[51] Cl. 24-02

[54] 藥物輸送裝置

Medication delivery device

[73] ELI LILLY AND COMPANY

P.O. Box 6288,

Indianapolis, IN 46206-6288,

United States of America

[74] MARKS & CLERK

Level 9, Cyberport 1,

100 Cyberport Road,

Pok Fu Lam, Hong Kong

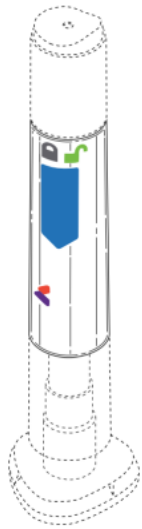

[11] 2422900.3M006

[15] 12-11-2022

[51] Cl. 24-02

[54] 藥物輸送裝置

Medication delivery device

[73] ELI LILLY AND COMPANY

P.O. Box 6288,

Indianapolis, IN 46206-6288,

United States of America

[74] MARKS & CLERK

Level 9, Cyberport 1,

100 Cyberport Road,

Pok Fu Lam, Hong Kong

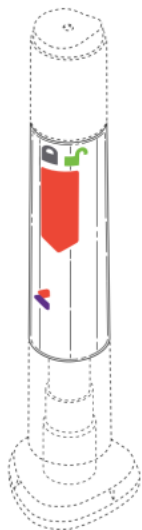

[11] 2422906.6M001

[15] 07-03-2024

[51] C1. 20-02

[54] 飾物陳列裝置

Ornament display device

[73] 六福集團有限公司

Luk Fook Holdings Company Limited
15th, 20th, 25th & 27th Floor,
Metropole Square, No.2 On Yiu Street,
Shatin, New Territories, Hong Kong

[74] Luk Fook Holdings Company Limited (Legal Affairs Department)

25/F, Metropole Square,
No.2 On Yiu Street,
Shatin, New Territories, Hong Kong



[11] 2422906.6M002

[15] 07-03-2024

[51] Cl. 20-02

[54] 飾物陳列裝置

Ornament display device

[73] 六福集團有限公司

Luk Fook Holdings Company Limited
15th, 20th, 25th & 27th Floor,
Metropole Square, No.2 On Yiu Street,
Shatin, New Territories, Hong Kong

[74] Luk Fook Holdings Company Limited (Legal Affairs Department)

25/F, Metropole Square,
No.2 On Yiu Street,
Shatin, New Territories, Hong Kong



[11] 2422906.6M003

[15] 07-03-2024

[51] Cl. 20-02

[54] 飾物陳列裝置

Ornament display device

[73] 六福集團有限公司

Luk Fook Holdings Company Limited
15th, 20th, 25th & 27th Floor,
Metropole Square, No.2 On Yiu Street,
Shatin, New Territories, Hong Kong

[74] Luk Fook Holdings Company Limited (Legal Affairs Department)

25/F, Metropole Square,
No.2 On Yiu Street,
Shatin, New Territories, Hong Kong



[11] 2422906.6M004

[15] 07-03-2024

[51] Cl. 20-02

[54] 飾物陳列裝置

Ornament display device

[73] 六福集團有限公司

Luk Fook Holdings Company Limited
15th, 20th, 25th & 27th Floor,
Metropole Square, No.2 On Yiu Street,
Shatin, New Territories, Hong Kong

[74] Luk Fook Holdings Company Limited (Legal Affairs Department)

25/F, Metropole Square,
No.2 On Yiu Street,
Shatin, New Territories, Hong Kong



[11] 2422906.6M005

[15] 07-03-2024

[51] Cl. 20-02

[54] 飾物陳列裝置

Ornament display device

[73] 六福集團有限公司

Luk Fook Holdings Company Limited
15th, 20th, 25th & 27th Floor,
Metropole Square, No.2 On Yiu Street,
Shatin, New Territories, Hong Kong

[74] Luk Fook Holdings Company Limited (Legal Affairs Department)

25/F, Metropole Square,
No.2 On Yiu Street,
Shatin, New Territories, Hong Kong



[11] 2422916.7

[15] 08-03-2024

[30] 20-11-2023 / JP / 023939 of 2023

[51] Cl. 7-02

[54] 滴頭

Dripper

[73] 玻璃王株式會社

HARIO Co., Ltd.
9-3, Nihonbashi Tomizawa-Cho,
Chuo-Ku, Tokyo 103-0006,
Japan

[74] CHINA PATENT AGENT (HONG KONG) LIMITED

22/F, Great Eagle Centre,
23 Harbour Road,
Wanchai, Hong Kong

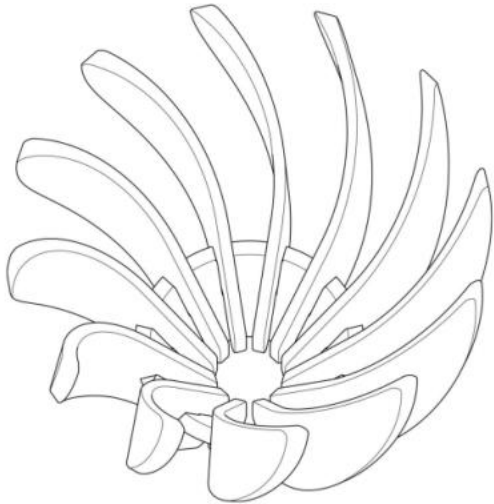

[11] 2422923.1

[15] 11-03-2024

[30] 20-09-2023 / CN / 202330614155.4

[51] Cl. 28-06

[54] 直髮器

Hair straightener

[73] 深圳市洋沃電子有限公司

Shenzhen Yangwo Electronic Co., Ltd.

中國廣東省深圳市

光明新區公明街道將石社區

上石家第三工業區 3 棟

[74] 智享國際智慧財產權投顧有限公司 (WShare International IP Investment
& Consultants Limited)

香港九龍

觀塘道 348

宏利廣場 6 樓

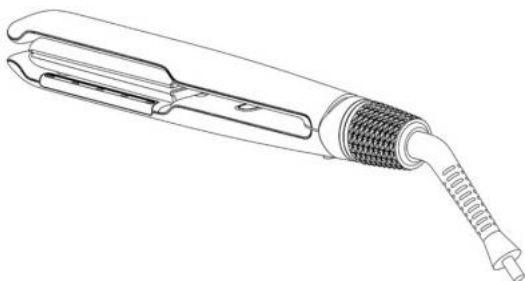

[11] 2422924.3

[15] 11-03-2024

[30] 13-11-2023 / CN / 202330741012.X

[51] Cl. 28-06

[54] 直髮器的加熱板

Heating plate for hair straighteners

[73] 深圳市洋沃電子有限公司

Shenzhen Yangwo Electronic Co., Ltd.

中國廣東省深圳市

光明新區公明街道將石社區

上石家第三工業區 3 棟

[74] 智享國際智慧財產權投顧有限公司 (WShare International IP Investment & Consultants Limited)

香港九龍

觀塘道 348

宏利廣場 6 樓

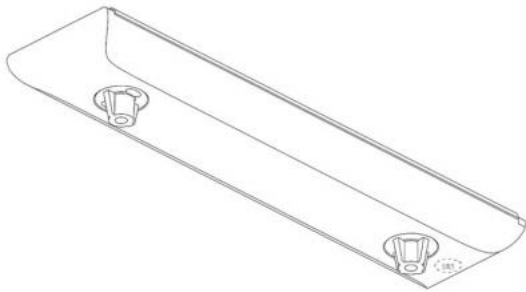

[11] 2422935.7M001

[15] 12-03-2024

[30] 12-09-2023 / US / 29/912,032

[51] Cl. 10-07

[54] 用於智能手錶的帶

Band for smartwatch

[73] 蘋果公司

APPLE INC.

One Apple Park Way, Cupertino,

California,

United States of America

[74] CLT PATENT & TRADEMARK (H.K.) LIMITED

Unit 09, 34/F., Office Tower, Convention Plaza,

1 Harbour Road,

Wanchai, Hong Kong



[11] 2422935.7M002

[15] 12-03-2024

[30] 12-09-2023 / US / 29/912,032

[51] Cl. 10-07

[54] 用於智能手錶的帶

Band for smartwatch

[73] 蘋果公司

APPLE INC.

One Apple Park Way, Cupertino,

California,

United States of America

[74] CLT PATENT & TRADEMARK (H.K.) LIMITED

Unit 09, 34/F., Office Tower, Convention Plaza,

1 Harbour Road,

Wanchai, Hong Kong



- [11] 2422946.0
[15] 13-03-2024
[30] 12-10-2023 / CN / 2023306611530
[51] Cl. 7-02
[54] 電飯煲
Electric rice cooker
[73] 佛山市顺德区美的电热电器制造有限公司
FOSHAN SHUNDE MIDEA ELECTRICAL HEATING APPLIANCES
MANUFACTURING CO.,LTD.
San Le Road #19, Beijiao, Shunde, Foshan,
Guangdong Province 528311,
China
[74] CLT PATENT & TRADEMARK (H.K.) LIMITED
Unit 09, 34/F., Office Tower, Convention Plaza,
1 Harbour Road,
Wanchai, Hong Kong



-
- [11] 2422958.5
[15] 14-03-2024
[30] 19-01-2024 / RU, SG, CH, TR, GB, EU / WIPO143354
[51] Cl. 11-01
[54] 手鐲
Bracelet
[73] VAN CLEEF & ARPELS SA
Route des Biches 8,
1752 Villars-sur-Glâne,
Switzerland
[74] ATL LAW OFFICES
16/F., China Hong Kong Tower,

8-12 Hennessy Road,
Wanchai, Hong Kong

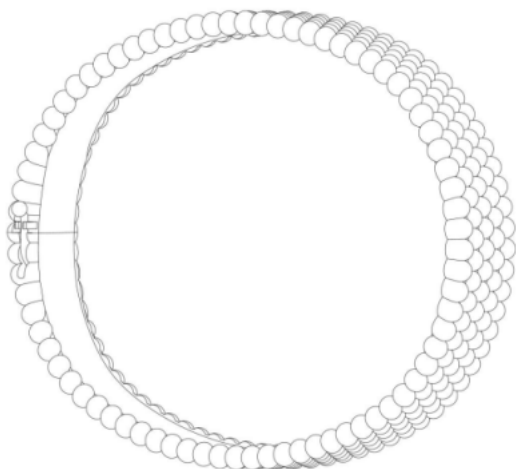

[11] 2422959.7

[15] 14-03-2024

[30] 19-01-2024 / RU, SG, CH, TR, GB, EU / WIPO143352

[51] Cl. 11-01

[54] 手鐲

Bracelet

[73] VAN CLEEF & ARPELS SA

Route des Biches 8,

1752 Villars-sur-Glâne,

Switzerland

[74] ATL LAW OFFICES

16/F., China Hong Kong Tower,

8-12 Hennessy Road,

Wanchai, Hong Kong

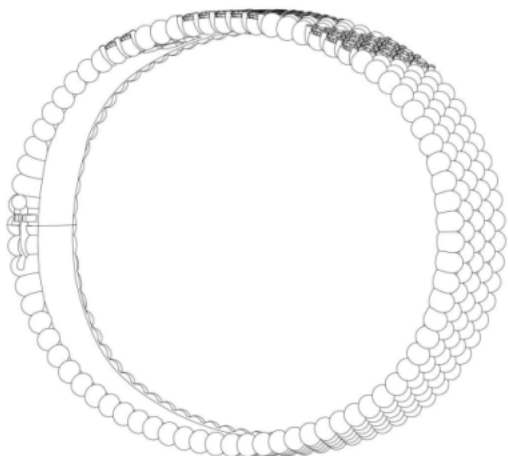

[11] 2422961.1

[15] 14-03-2024

[51] Cl. 23-04

[54] 風扇
Fan

[73] 領明實業有限公司
香港屯門
杯渡路 76 號
屯門工業中心 E 座一字樓二號室

[74] 領明實業有限公司
香港屯門
杯渡路 76 號
屯門工業中心 E 座一字樓二號室

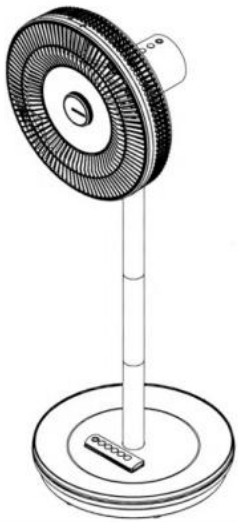

[11] 2422964.7

[15] 15-03-2024

[51] Cl. 7-01

[54] 卷邊雙格餐盒
Turned edge lunch box with 2 compartments

[73] 保達包裝物料有限公司
Sureway Packing Material Company Limited
香港葵涌
青山道業成街 19-21 號
業成工業中心 10 樓 A 室

[74] 卓遠知識產權有限公司
香港上環
禧利街 27 號
富輝商業中心 10 樓

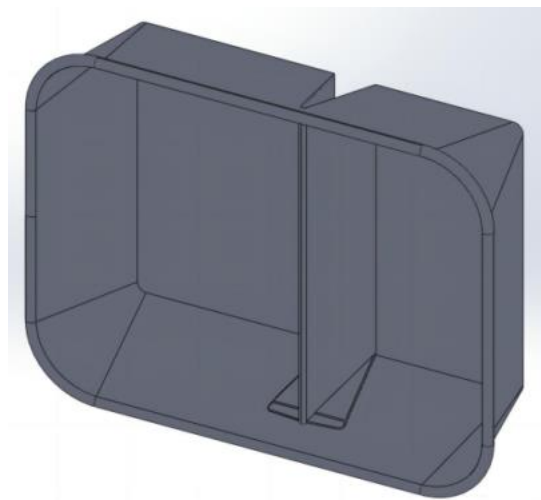

[11] 2422966.2M001

[15] 15-03-2024

[30] 23-10-2023 / CH / 147640

[51] Cl. 10-07

[54] 手錶錶盤

Watch dial

[73] ROLEX SA

Rue François-Dussaud 3-5-7,

1211 Genève 26,

Switzerland

[74] DEACONS

5th Floor, Alexandra House,

Central,

Hong Kong

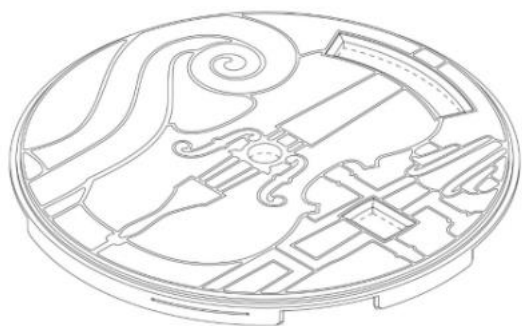

[11] 2422966.2M002

[15] 15-03-2024

[30] 23-10-2023 / CH / 147640

[51] Cl. 10-07

[54] 手錶錶盤

Watch dial

[73] ROLEX SA

Rue François-Dussaud 3-5-7,
1211 Genève 26,
Switzerland

[74] DEACONS

5th Floor, Alexandra House,
Central,
Hong Kong



[11] 2422967.4

[15] 15-03-2024

[30] 28-09-2023 / EU / 015035517

[51] Cl. 3-01

[54] 包

Bag

[73] ROGER VIVIER S.P.A

Via Filippo Della Valle 1,
I-63811 Sant'Elpidio A Mare (Fermo),
Italy

[74] CHINA PATENT AGENT (HONG KONG) LIMITED

22/F, Great Eagle Centre,
23 Harbour Road,
Wanchai, Hong Kong



[11] 2422970.0

[15] 15-03-2024

[51] Cl. 11-01

[54] 鮑魚扣

Abalone clasp

[73] 广州市天丰珠宝有限公司

Tin Fung Jewellery Limited (Guangzhou)

中國广东省

广州市番禺区沙头街道

银建路 34 号二楼

[74] LISHI INTELLECTUAL PROPERTY GROUP (INTERNATIONAL) LIMITED

香港九龍觀塘

興業街 15-17 號

中美中心 B 座 9 樓 9045 室



[11] 2422971.2

[15] 15-03-2024

[51] Cl. 11-01

[54] 龍蝦扣

Lobster clasp

[73] 广州市天丰珠宝有限公司

Tin Fung Jewellery Limited (Guangzhou)

中國广东省

广州市番禺区沙头街道

银建路 34 号二楼

[74] LISHI INTELLECTUAL PROPERTY GROUP (INTERNATIONAL) LIMITED

香港九龍觀塘

興業街 15-17 號

中美中心 B 座 9 樓 9045 室

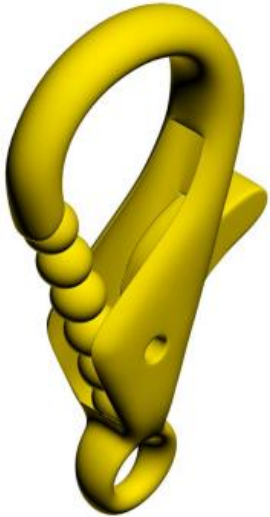

[11] 2422981.3

[15] 19-03-2024

[30] 22-09-2023 / EU / 015034999-0004

[51] Cl. 3-01

[54] 手袋

Handbag

[73] BOTTEGA VENETA S.R.L.

Località Conti Maltraverso 1,

36054 Montebello Vicentino (VI),

Italy

[74] ELLALAN

26th - 28th Floors, The Hennessy,

256 Hennessy Road,

Wanchai, Hong Kong



[11] 2422996.5

[15] 21-03-2024

[51] Cl. 21-03

[54] 遊戲機

Gaming machine

[73] ATTA Technologies Limited
Unit 801, 8/F, Midas Plaza,
No.1 Tai Yau Street,
San Po Kong, Hong Kong

[74] REAL AND COMPLEX INTELLECTUAL PROPERTY SERVICES LIMITED
Flat C, 7/F, Kwai Bo Ind. Bldg.,
40 Wong Chuk Hang Road,
Aberdeen, Hong Kong

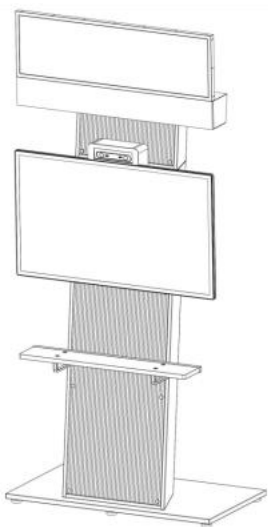

[11] 2423079.1

[15] 07-04-2024

[51] Cl. 19-08

[54] 食品包裝標貼

A label for foodstuffs packaging

[73] 株式会社八道

PALDO CO., LTD.

7th Floor, 577, Gangnam-daero, Seocho-gu, Seoul,
Republic of Korea

[74] UNITALEN ATTORNEYS AT LAW LIMITED

Unit No.1211, Level 12, Tower 1,
Grand Century Place,
193 Prince Edward Road West,
Mongkok, Kowloon, Hong Kong



[11] 2423087.8

[15] 08-04-2024

[51] Cl. 9-03

[54] 包裝盒

Packing box

[73] 日本佐川藥業株式會社有限公司

香港

新界沙田源順圍

沙田工業中心 A 座 3 樓 3 室

[74] 日本佐川藥業株式會社有限公司

香港

新界沙田源順圍

沙田工業中心 A 座 3 樓 3 室

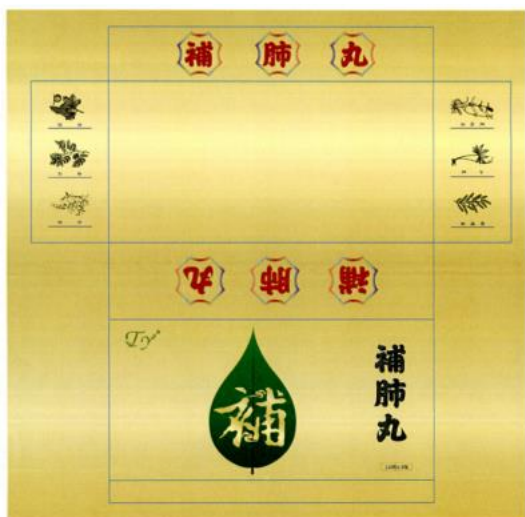

[11] 2423093.0

[15] 08-04-2024

[30] 19-12-2023 / CN, SG, CH, GB, EU, JP, KR / DM/234282

[51] Cl. 10-07

[54] 錶面

Watch dial

[73] VAN CLEEF & ARPELS SA

Route des Biches 8,
1752 Villars-sur-Glâne,
Switzerland

[74] ATL LAW OFFICES

16/F., China Hong Kong Tower,
8-12 Hennessy Road, Wanchai,
Hong Kong



[11] 2423095.5M001

[15] 09-04-2024

[51] Cl. 21-01

[54] 玩具
Toy

[73] LEGO A/S
Aastvej 1, 7190 Billund,
Denmark

[74] LIU, SHEN & ASSOCIATES
Room 3716, 37/F, Sun Hung Kai Centre,
30 Harbour Road, Wanchai,
Hong Kong

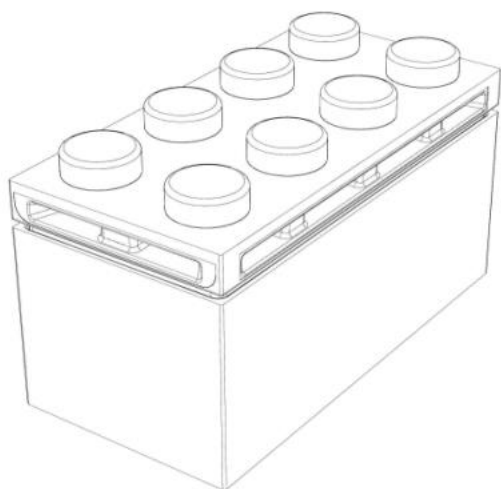

[11] 2423095.5M002

[15] 09-04-2024

[51] Cl. 21-01

[54] 玩具
Toy

[73] LEGO A/S
Aastvej 1, 7190 Billund,
Denmark

[74] LIU, SHEN & ASSOCIATES
Room 3716, 37/F, Sun Hung Kai Centre,
30 Harbour Road, Wanchai,
Hong Kong

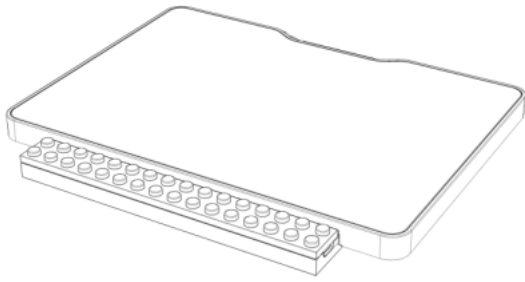

[11] 2423095.5M003

[15] 09-04-2024

[51] Cl. 21-01

[54] 玩具
Toy

[73] LEGO A/S
Aastvej 1, 7190 Billund,
Denmark

[74] LIU, SHEN & ASSOCIATES
Room 3716, 37/F, Sun Hung Kai Centre,
30 Harbour Road, Wanchai,
Hong Kong

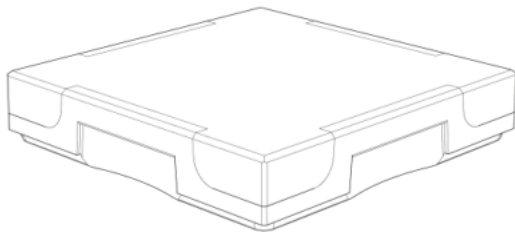

[11] 2423103.3M001

[15] 09-04-2024

[30] 12-10-2023 / EU / 015036860-0001

[51] Cl. 6-09

[54] 坐墊
Cushion

[73] Emma Sleep GmbH
Wilhelm-Leuschner-Straße 78,
60329 Frankfurt am Main,
Germany

[74] VIVIEN CHAN & CO
32/F, Harbour Centre,
25 Harbour Road, Wanchai,
Hong Kong

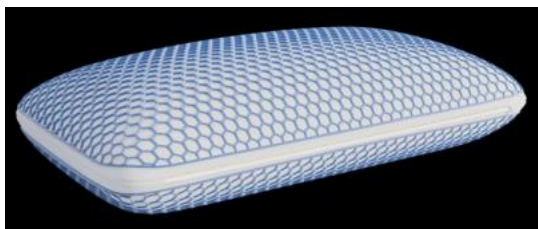

[11] 2423103.3M002

[15] 09-04-2024

[30] 12-10-2023 / EU / 015036860-0002

[51] Cl. 6-09

[54] 坐墊

Cushion

[73] Emma Sleep GmbH

Wilhelm-Leuschner-Straße 78,

60329 Frankfurt am Main,

Germany

[74] VIVIEN CHAN & CO

32/F, Harbour Centre,

25 Harbour Road, Wanchai,

Hong Kong

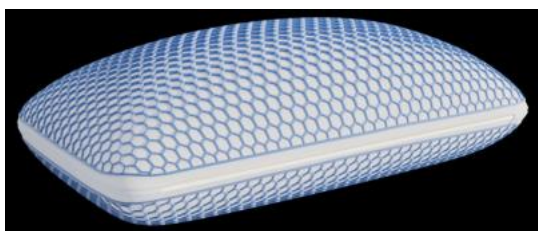

[11] 2423105.8

[15] 09-04-2024

[30] 29-11-2023 / SE / 2023-0226

[51] Cl. 12-16

[54] 車輛用側板艙門

Side panel hatch for vehicle

[73] Scania CV AB

SE-151 87 Södertälje,

Sweden

[74] NTD PATENT & TRADE MARK AGENCY LIMITED

Units 1805-6, 18/F., Greenfield Tower, Concordia Plaza,

No. 1 Science Museum Road, Tsimshatsui East, Kowloon,

Hong Kong



[11] 2423106.0M001

[15] 10-04-2024

[30] 13-10-2023 / JP / 2023-021197

[51] Cl. 15-07

[54] 冰箱

Refrigerator

[73] 三菱电机株式会社

Mitsubishi Electric Corporation

7-3, Marunouchi 2-chome,

Chiyoda-ku, Tokyo 100-8310,

Japan

[74] SANYOU INTELLECTUAL PROPERTY LIMITED

Unit 2301, 23/F, Golden Centre,

188 Des Voeux Road Central,

Hong Kong

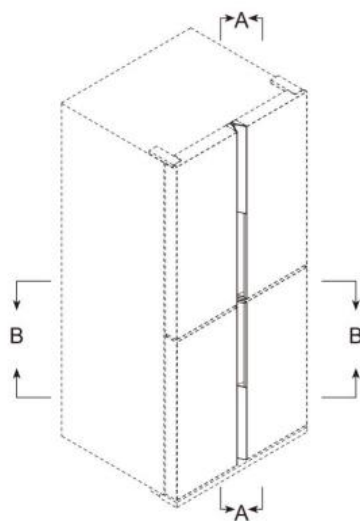

[11] 2423106.0M002

[15] 10-04-2024

[30] 13-10-2023 / JP / 2023-021198

[51] Cl. 15-07

[54] 冰箱

Refrigerator

[73] 三菱电机株式会社

Mitsubishi Electric Corporation

7-3, Marunouchi 2-chome,

Chiyoda-ku, Tokyo 100-8310,

Japan

[74] SANYOU INTELLECTUAL PROPERTY LIMITED

Unit 2301, 23/F, Golden Centre,

188 Des Voeux Road Central,

Hong Kong

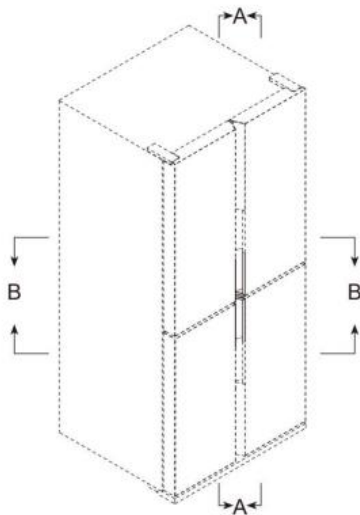

[11] 2423110.8

[15] 10-04-2024

[51] Cl. 17-04

[54] 柒沙蛋

Seven egg shaker

[73] 劉敬文

LAU King Man

香港

粉嶺和滿街 8 號

帝庭軒 2 座 12 樓 H 室

[74] LAU KING MAN

RM. H, 12/F., BLK 2,

REGENTVILLE, FANLING,
HONG KONG



[11] 2423111.0

[15] 10-04-2024

[30] 25-10-2023 / CA, AM, AZ, BA, GE, LI, MK, MD, MX, MC, ME, NO,
OM, RU, SG, CH, TN, TR, UA, GB, EU, AL, IL, JP, KR / DM/232836

[51] Cl. 3-01

[54] 錶盒

Watch case

[73] ETA SA Manufacture Horlogere Suisse
Schild-Rust-Strasse 17,
2540 Grenchen,
Switzerland

[74] SPRUSON & FERGUSON (HONG KONG) LIMITED
5001 Hopewell Centre,
183 Queen's Road East, Wan Chai,
Hong Kong

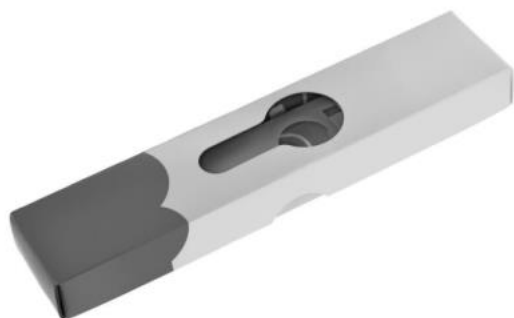

[11] 2423114.6

[15] 10-04-2024

[51] Cl. 6-06

[54] 收銀台

Checkout counter

[73] TUHU Car (Hong Kong) Limited

Room 2609, China Resources Building,

26 Harbour Road, Wanchai,

Hong Kong

[74] ACCOLADE IP LIMITED

10/F, Fu Fai Comm. Ctr.,

27 Hillier Street, Sheung Wan,

Hong Kong



[11] 2423115.9

[15] 10-04-2024

[51] Cl. 25-03

[54] 門頭

Store front

[73] TUHU Car (Hong Kong) Limited

Room 2609, China Resources Building,

26 Harbour Road, Wanchai,

Hong Kong

[74] ACCOLADE IP LIMITED

10/F, Fu Fai Comm. Ctr.,

27 Hillier Street, Sheung Wan,

Hong Kong



[11] 2423116.1

[15] 10-04-2024

[51] Cl. 25-02

[54] 形象牆

Feature wall

[73] TUHU Car (Hong Kong) Limited
Room 2609, China Resources Building,
26 Harbour Road, Wanchai,
Hong Kong

[74] ACCOLADE IP LIMITED
10/F, Fu Fai Comm. Ctr.,
27 Hillier Street, Sheung Wan,
Hong Kong



[11] 2423117.3

[15] 10-04-2024

[51] Cl. 25-02

[54] 收銀背景牆

Checkout background wall

[73] TUHU Car (Hong Kong) Limited
Room 2609, China Resources Building,
26 Harbour Road, Wanchai,
Hong Kong

[74] ACCOLADE IP LIMITED
10/F, Fu Fai Comm. Ctr.,
27 Hillier Street, Sheung Wan,
Hong Kong



[11] 2423118.5

[15] 10-04-2024

[51] Cl. 6-06

[54] 導購台

Shop counter

[73] TUHU Car (Hong Kong) Limited
Room 2609, China Resources Building,
26 Harbour Road, Wanchai,
Hong Kong

[74] ACCOLADE IP LIMITED
10/F, Fu Fai Comm. Ctr.,
27 Hillier Street, Sheung Wan,
Hong Kong



[11] 2423119.7M001

[15] 11-04-2024

[30] 15-12-2023 / EU / 015044655-0001

[51] Cl. 9-01

[54] 瓶子
Bottle

[73] SOCIETE DES EAUX DE VOLVIC
Zone Industrielle du Chancet, 63530 Volvic,
France

[74] HASTINGS & CO
5/F, Gloucester Tower, The Landmark,
11 Pedder Street, Central,
Hong Kong



[11] 2423119.7M002

[15] 11-04-2024

[30] 15-12-2023 / EU / 015044655-0002

[51] Cl. 9-01

[54] 瓶子
Bottle

[73] SOCIETE DES EAUX DE VOLVIC
Zone Industrielle du Chancet, 63530 Volvic,
France

[74] HASTINGS & CO
5/F, Gloucester Tower, The Landmark,
11 Pedder Street, Central,
Hong Kong

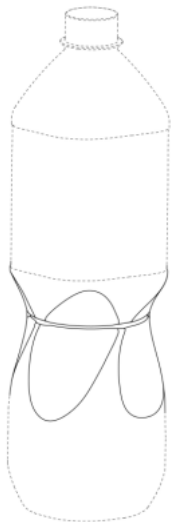

[11] 2423133.6

[15] 15-04-2024

[30] 26-02-2024 / CN, SG, CH, GB, EU, JP, KR / DM/235888

[51] Cl. 10-02

[54] 手錶

Watch

[73] Cartier International AG

Hinterbergstrasse 22,

6312 Steinhausen,

Switzerland

[74] ATL LAW OFFICES

16/F., China Hong Kong Tower,

8-12 Hennessy Road, Wanchai,

Hong Kong

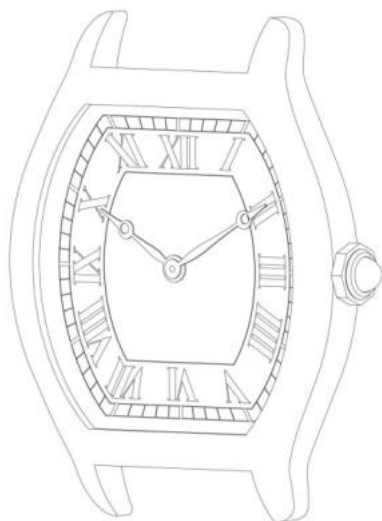

- [11] 2423134.8M001
- [15] 15-04-2024
- [30] 10-11-2023 / CA, AM, AZ, BZ, BA, GE, LI, MK, MD, MC, MN, ME, MA, NO, OM, SG, CH, TN, TR, UA, GB, EU, AL, KG / DM/233160
- [51] Cl. 11-01
- [54] 指環
Ring
- [73] Harry Winston SA
Chemin du Tourbillon 8,
CH-1228 Plan-les-Ouates,
Switzerland
- [74] SPRUSON & FERGUSON (HONG KONG) LIMITED
5001 Hopewell Centre,
183 Queen's Road East, Wan Chai,
Hong Kong



-
- [11] 2423134.8M002
 - [15] 15-04-2024
 - [30] 10-11-2023 / CA, AM, AZ, BZ, BA, GE, LI, MK, MD, MC, MN, ME, MA, NO, OM, SG, CH, TN, TR, UA, GB, EU, AL, KG / DM/233160
 - [51] Cl. 11-01
 - [54] 項鍊
Necklace
 - [73] Harry Winston SA
Chemin du Tourbillon 8,
CH-1228 Plan-les-Ouates,
Switzerland
 - [74] SPRUSON & FERGUSON (HONG KONG) LIMITED
5001 Hopewell Centre,

183 Queen's Road East, Wan Chai,
Hong Kong



[11] 2423134.8M003

[15] 15-04-2024

[30] 10-11-2023 / CA, AM, AZ, BZ, BA, GE, LI, MK, MD, MC, MN, ME,
MA, NO, OM, SG, CH, TN, TR, UA, GB, EU, AL, KG / DM/233160

[51] Cl. 11-01

[54] 項鍊

Necklace

[73] Harry Winston SA

Chemin du Tourbillon 8,
CH-1228 Plan-les-Ouates,
Switzerland

[74] SPRUSON & FERGUSON (HONG KONG) LIMITED

5001 Hopewell Centre,
183 Queen's Road East, Wan Chai,
Hong Kong



[11] 2423134.8M004

[15] 15-04-2024

[30] 10-11-2023 / CA, AM, AZ, BZ, BA, GE, LI, MK, MD, MC, MN, ME,
MA, NO, OM, SG, CH, TN, TR, UA, GB, EU, AL, KG / DM/233160

[51] Cl. 11-01

[54] 耳環

Earrings

- [73] Harry Winston SA
Chemin du Tourbillon 8,
CH-1228 Plan-les-Ouates,
Switzerland
- [74] SPRUSON & FERGUSON (HONG KONG) LIMITED
5001 Hopewell Centre,
183 Queen's Road East, Wan Chai,
Hong Kong



-
- [11] 2423138.7
- [15] 16-04-2024
- [30] 17-10-2023 / US / 29/914,421
- [51] Cl. 22-01
- [54] 半透明彈匣
Translucent magazine
- [73] Magpul Industries Corp.
5408 US Highway 290 West, Austin, TX 78735,
United States of America
- [74] TRADEMARKCN COMPANY LIMITED
Block A, 4/F., Granville Building,
14 Granville Road, Tsim Sha Tsui, Kowloon,
Hong Kong

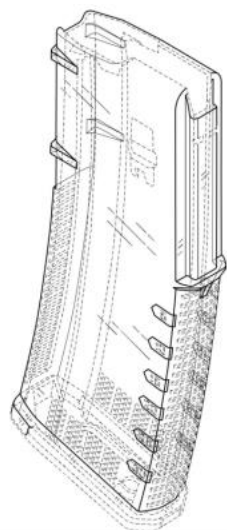

[11] 2423140.1M001

[15] 16-04-2024

[51] Cl. 11-01

[54] 珠寶飾品
Jewellery ornament

[73] 周大福珠寶金行(深圳)有限公司
CHOW TAI FOOK JEWELLERY (SHENZHEN) CO., LTD.
中國
廣東省深圳市鹽田區深鹽路
黃金珠寶大廈 12 樓 A 座

[74] 中一聯合國際知識產權有限公司
香港
九龍尖沙咀漆咸道南 45-51 號
其士大廈 803 室



[11] 2423140.1M002

[15] 16-04-2024

[51] Cl. 11-01

[54] 珠寶飾品

Jewellery ornament

[73] 周大福珠寶金行(深圳)有限公司

CHOW TAI FOOK JEWELLERY (SHENZHEN) CO., LTD.

中國

廣東省深圳市鹽田區深鹽路

黃金珠寶大廈 12 樓 A 座

[74] 中一聯合國際知識產權有限公司

香港

九龍尖沙咀漆咸道南 45-51 號

其士大廈 803 室



[11] 2423140.1M003

[15] 16-04-2024

[51] Cl. 11-01

[54] 珠寶飾品

Jewellery ornament

[73] 周大福珠寶金行(深圳)有限公司

CHOW TAI FOOK JEWELLERY (SHENZHEN) CO., LTD.

中國

廣東省深圳市鹽田區深鹽路

黃金珠寶大廈 12 樓 A 座

[74] 中一聯合國際知識產權有限公司

香港

九龍尖沙咀漆咸道南 45-51 號

其士大廈 803 室



[11] 2423140.1M004

[15] 16-04-2024

[51] Cl. 11-01

[54] 珠寶飾品

Jewellery ornament

[73] 周大福珠宝金行(深圳)有限公司

CHOW TAI FOOK JEWELLERY (SHENZHEN) CO., LTD.

中國

广东省深圳市盐田区深盐路

黄金珠宝大厦 12 楼 A 座

[74] 中一聯合國際知識產權有限公司

香港

九龍尖沙咀漆咸道南 45-51 號

其士大廈 803 室



[11] 2423140.1M005

[15] 16-04-2024

[51] Cl. 11-01

[54] 珠寶飾品

Jewellery ornament

[73] 周大福珠宝金行(深圳)有限公司

CHOW TAI FOOK JEWELLERY (SHENZHEN) CO., LTD.

中國

广东省深圳市盐田区深盐路

黄金珠宝大厦 12 楼 A 座

[74] 中一聯合國際知識產權有限公司

香港

九龍尖沙咀漆咸道南 45-51 號
其士大廈 803 室



[11] 2423140.1M006

[15] 16-04-2024

[51] Cl. 11-01

[54] 珠寶飾品

Jewellery ornament

[73] 周大福珠宝金行(深圳)有限公司

CHOW TAI FOOK JEWELLERY (SHENZHEN) CO., LTD.

中國

广东省深圳市盐田区深盐路

黄金珠宝大厦 12 楼 A 座

[74] 中一聯合國際知識產權有限公司

香港

九龍尖沙咀漆咸道南 45-51 號

其士大廈 803 室



[11] 2423140.1M007

[15] 16-04-2024

[51] Cl. 11-01

[54] 珠寶飾品

Jewellery ornament

[73] 周大福珠宝金行(深圳)有限公司

CHOW TAI FOOK JEWELLERY (SHENZHEN) CO., LTD.

中國

广东省深圳市盐田区深盐路

黄金珠宝大厦 12 楼 A 座

[74] 中一聯合國際知識產權有限公司

香港

九龍尖沙咀漆咸道南 45-51 號

其士大廈 803 室



[11] 2423164.1

[15] 18-04-2024

[30] 03-04-2024 / CN / 2024301844539

[51] C1. 13-02

[54] 無線充電寶

Wireless power bank

[73] 深圳市酷啦科技有限公司

Shenzhen Kula Technology Co.,LTD

中國

广东省深圳市龙华区福城街道

茜坑社区鸿创科技中心 6 栋 1001

[74] 卓遠知識產權有限公司

香港

上環禧利街 27 號

富輝商業中心 10 樓





香港特別行政區政府知識產權署外觀設計註冊處

The Government of the Hong Kong Special Administrative Region

Designs Registry, Intellectual Property Department

根據註冊外觀設計條例第 28 條，下列註冊外觀設計因未繳續期費而停止有效。

各組記項按註冊外觀設計停止有效日期及註冊編號先後次序排列。

Registered designs ceased through non-payment of renewal fees under section 28 of the Registered Designs Ordinance. Entries are listed below under their expiry dates.

10-04-2024 - 17-04-2024

10-04-2024	0900591.1	1913461.2M002
1400680.7	1400703.7M001	1913461.2M003
1913420.6	1400703.7M002	1913461.2M004
1913421.8	1400706.4M001	1913461.2M006
1913422.0	1400706.4M002	1913461.2M007
1913424.4	1400706.4M003	1913462.4M001
1913426.9	1400706.4M004	1913462.4M002
1913429.5	1400706.4M005	1913462.4M003
1913430.7	1400706.4M006	1913462.4M004
1913432.1	1400706.4M007	
1913433.3	1400706.4M008	16-04-2024
1913434.5M001	1400706.4M009	0900610.3
1913434.5M002	1400706.4M010	1400718.9
	1400706.4M011	1913466.3
11-04-2024	1400706.4M012	1913468.7
1913435.8	1400707.6	1913469.9
1913436.0	1400708.8	1913470.1
1913437.2	1913446.1	
1913443.4	1913452.3M001	17-04-2024
1913444.6M001	1913452.3M002	1913472.5
1913444.6M002	1913454.7	1913476.4
1913445.9M001	1913458.6	1913478.8M001
1913445.9M002		1913478.8M002
	15-04-2024	1913479.0M001
13-04-2024	0900596.2	
0410776.1	0900598.6	
1400697.3M001	1400715.3M002	
1400697.3M002	1913460.0M001	
1400697.3M003	1913460.0M002	
1400697.3M004	1913460.0M003	
1400699.7	1913460.0M004	
1400701.3	1913460.0M005	
	1913460.0M006	
14-04-2024	1913461.2M001	



香港特別行政區政府知識產權署外觀設計註冊處

The Government of the Hong Kong Special Administrative Region

Designs Registry, Intellectual Property Department

根據註冊外觀設計規則第 31 條刪除的註冊外觀設計。各組記項按註冊外觀設計刪除日期及註冊編號先後次序排列。

Registered designs removed under section 31 of the Registered Designs Rules. Entries are listed below under their removal dates.

18-04-2024 - 25-04-2024

18-04-2024	0802499.6	0311775.9
1301789.8M003	0802500.1M001	0802543.1
1301791.2M001	0802500.1M002	0802546.8
1301791.2M002	0802500.1M003	0803004.9
1301792.4M005	0802500.1M004	0803005.2
1301792.4M006	0802500.1M005	0803006.4
1301792.4M009	0802500.1M006	1301828.2
1301792.4M010	0802500.1M007	
1301792.4M011	0802501.3M001	25-04-2024
1301792.4M012	0802501.3M002	1301835.7
1301792.4M013	0802501.3M003	1301836.9
1301792.4M014	0802501.3M004	1301842.1
1301792.4M015		1301843.3
1301792.4M016	22-04-2024	1301845.8
1301792.4M017	0311723.9	1301850.8M009
1301792.4M018	0802515.3	1301850.8M015
1301792.4M019	0802517.7	1801915.2
1301792.4M020	0802518.9	1802080.0
1301792.4M021	0802519.1M001	1802081.2M001
1802041.8	1802056.0	1802081.2M002
1802042.0M001	1802059.6	1802081.2M003
1802042.0M002	1802061.0	1802082.4
1802043.2M001	1802063.4	1802085.1M001
1802043.2M002		1802085.1M002
1802044.4	23-04-2024	
	0311748.2	
19-04-2024	0802524.1	
1802046.9	1802072.3M001	
1802047.1	1802072.3M002	
1802048.3	1802073.5M001	
1802049.5M001	1802073.5M002	
1802049.5M002	1802076.2	

20-04-2024

24-04-2024



香港特別行政區政府知識產權署外觀設計註冊處
The Government of the Hong Kong Special Administrative Region
Designs Registry, Intellectual Property Department

根據註冊外觀設計條例第 76 條，更正已提交文件中的錯誤 Correction of errors in filed documents under section 76 of the Registered Designs Ordinance

任何人士現可對下列更正錯誤的請求提出反對

Request for correction of errors now open to opposition

如任何人士意欲反對下列請求，則須在本官方公報刊登是項更正請求的日期起計的兩個月內，根據註冊外觀設計規則第 62(4) 條，採用指明外觀設計表格第 D9 號提交反對通知。如在限期內沒有收到任何反對通知，處長將依本公報刊登的更正請求的內容，准許是項更正請求。

If any person wishes to oppose the following request, he shall file a notice of opposition in specified Designs Form D9 within two months from the date of advertisement in this official journal under section 62(4) of the Registered Designs Rules. If no notice of opposition is received, the request for correction will be allowed by the Registrar in the present advertised form.

請求更正外觀設計表格第 D1 號第 03 部分中申請人的姓名或名稱

Request made for correction of applicant's name in Part 03 of the Designs Form D1 filed

[21] 2321901.3

[71] 東保集團有限公司

Tunbow Group Limited

請求更正表述的錯誤

Request made for correction of errors in representations

[21] 2321732.4

[55] 外觀設計的表述

Representations of the Design

[21] 2321733.6

[55] 外觀設計的表述

Representations of the Design