

# 香港知識產權公報

Hong Kong Intellectual Property Journal

2024年4月12日

12 April 2024

## 目錄 Contents

### 根據註冊外觀設計條例第 25 條註冊的外觀設計

#### **Designs Registered under section 25 of the Registered Designs Ordinance**

按註冊編號排列

Arranged by Registration Number

### 根據註冊外觀設計條例(第 522 章)公布的其他公告

#### **Other Notices Published under the Registered Designs Ordinance (Cap. 522)**

根據註冊外觀設計條例第 28 條，註冊外觀設計因未繳續期費而停止有效

Registered designs ceased through non-payment of renewal fees under section 28 of the Registered Designs Ordinance

根據註冊外觀設計規則第 31 條刪除的註冊外觀設計

Registered designs removed under section 31 of the Registered Designs Rules

### 以下事項沒有記錄

#### **No Records for the Following Matters**

根據註冊外觀設計條例第 30 條放棄的外觀設計的註冊

Surrender of Registration of Design under section 30 of the Registered Designs Ordinance

根據註冊外觀設計規則第 37 條，向處長作出轉介

Reference to Registrar under section 37 of the Registered Designs Rules

根據註冊外觀設計條例第 45 條，撤銷註冊

Revocation of Registration under section 45 of the Registered Designs Ordinance

根據註冊外觀設計規則第 46 條，向法院作出轉介

Reference to Court under section 46 of the Registered Designs Rules

根據註冊外觀設計規則第 63 條對不符合規定之處作出糾正

Rectification of Irregularities under section 63 of the Registered Designs Rules

根據註冊外觀設計條例第 66 條，糾正註冊紀錄冊

Rectification of Register under section 66 of the Registered Designs Ordinance

根據註冊外觀設計條例第 67 條 更正註冊紀錄冊內的錯誤

Correction of errors in Register under section 67 of the Registered Designs Ordinance

根據註冊外觀設計條例第 67 及 76 條，更正註冊紀錄冊內及已提交文件中的錯誤

Correction of Errors in Register and in Filed Documents under sections 67 and 76 of the Registered Designs Ordinance

根據註冊外觀設計條例第 76 條，更正已提交文件中的錯誤

Correction of errors in filed documents under section 76 of the Registered Designs Ordinance

勘誤

Corrigendum

## 註冊外觀設計公告註釋

### Notes on advertisements of registration of designs

方括號表示下列資料：

Square brackets indicate the following data：

[11] 註冊編號 Registration number / 聯合王國註冊編號 United Kingdom registration number

[15] 註冊日期 Registration date / 當作註冊日期 Deemed registration date / 聯合王國註冊日期 United Kingdom registration date

[17] 註冊有效期屆滿日期 Expiry date of the period of registration

[22] 提交日期 Filing date / 當作提交日期 Deemed filing date / 聯合王國提交日期 United Kingdom filing date

[30] 聲稱享有的優先權（提交日期 / 巴黎公約國或世界貿易組織成員 / 申請編號） Priority claimed (filing date / Paris Convention country or WTO member / application number)

[51] 國際外觀設計分類號（洛迦諾分類號） International Classification of designs (Locarno Classification)

[54] 物品 Article

[55] 外觀設計的表述 Representation of the design

[62] 分開前的申請編號及提交日期 Application number before division and filing date

[66] 過往註冊的聯繫外觀設計註冊編號 / 日期 Registration No. / Date of Previous Registration for Association

[72] 設計人 Designer

[73] 擁有人姓名和地址 Name and address of the owner

[74] 代理人 Agent /送達地址 Address for service



香港特別行政區政府知識產權署外觀設計註冊處  
The Government of the Hong Kong Special Administrative Region  
Designs Registry, Intellectual Property Department

## 根據註冊外觀設計條例第 25 條註冊的外觀設計

### Designs registered under section 25 of the Registered Designs Ordinance

按註冊編號排列

Arranged by Registration Number

- [11] 2322163.7
- [15] 30-09-2023
- [30] 02-04-2023 / FR / 20231550
- [51] Cl. 11-01
- [54] 首飾  
Jewellery
- [73] LOUIS VUITTON MALLETIER  
2 rue du Pont-Neuf,  
75001 Paris,  
France
- [74] BAKER & MCKENZIE  
14th Floor, One Taikoo Place,  
979 King's Road,  
Quarry Bay, Hong Kong

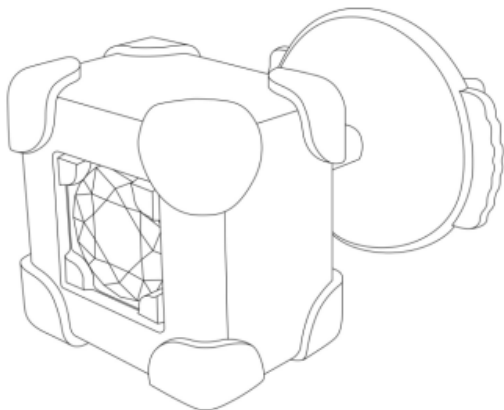

- 
- [11] 2322558.6M001
  - [15] 15-12-2023
  - [51] Cl. 13-02

[54] 膠囊行動電源連支架

Capsule powerbank with stand

[73] 創新產品有限公司

INNOVATION PRODUCTS LIMITED

Flat/Rm 1903, 19/F, Elite Centre,

22 Hung To Road,

Kwun Tong, Kowloon, Hong Kong

[74] INNOVATION PRODUCTS LIMITED (創新產品有限公司)

Flat/Rm 1903, 19/F, Elite Centre,

22 Hung To Road,

Kwun Tong, Kowloon, Hong Kong



---

[11] 2322558.6M002

[15] 15-12-2023

[51] Cl. 13-02

[54] 迷你行動電源連支架

Mini power bank with stand

[73] 創新產品有限公司

INNOVATION PRODUCTS LIMITED

Flat/Rm 1903, 19/F, Elite Centre,

22 Hung To Road,

Kwun Tong, Kowloon, Hong Kong

[74] INNOVATION PRODUCTS LIMITED (創新產品有限公司)

Flat/Rm 1903, 19/F, Elite Centre,

22 Hung To Road,

Kwun Tong, Kowloon, Hong Kong



---

[11] 2322565.1

[15] 18-12-2023

[30] 07-07-2023 / SG, CH, TR, GB, EU / DM/230 875

[51] Cl. 10-07

[54] 錶面

Dial

[73] HAMILTON INTERNATIONAL AG (HAMILTON INTERNATIONAL SA)  
(HAMILTON INTERNATIONAL LTD.)

Länggasse 85,  
2504 Biel/Bienne,  
Switzerland

[74] SPRUSON & FERGUSON (HONG KONG) LIMITED

5001 Hopewell Centre,  
183 Queen's Road East,  
Wan Chai, Hong Kong



---

[11] 2322592.7

[15] 22-12-2023

[30] 28-06-2023 / FR / 20232921

[51] Cl. 10-07



[54] 錶殼

Watch case

[73] GERALD G. SA

c/o La Fabrique du Temps Louis Vuitton SA,  
Rue Alphonse-Large 11, 1217 Meyrin,  
Swaziland

[74] BAKER & MCKENZIE

14th Floor, One Taikoo Place,  
979 King's Road,  
Quarry Bay, Hong Kong



---

[11] 2322606.9

[15] 29-12-2023

[51] Cl. 9-03

[54] 包裝盒

Packing box

[73] 蔡應選

CAI YING XUAN  
Flat/Rm #PA, Block 2, 21/F, Kingswin Bldg.,  
32-50 Lei Muk Road,  
Kwai Chung, New Territories, Hong Kong

[74] 蔡應選

Flat/Rm #PA, Block 2, 21/F, Kingswin Bldg.,  
32-50 Lei Muk Road,  
Kwai Chung, New Territories, Hong Kong



- [11] 2422613.4
- [15] 03-01-2024
- [51] C1. 21-01
- [54] 狗仔公仔  
Dog figure

[73] 劉敬文  
LAU KING MAN  
香港粉嶺  
帝庭軒 2 座  
12 樓 H 室

[74] 劉敬文  
香港粉嶺  
帝庭軒 2 座  
12 樓 H 室

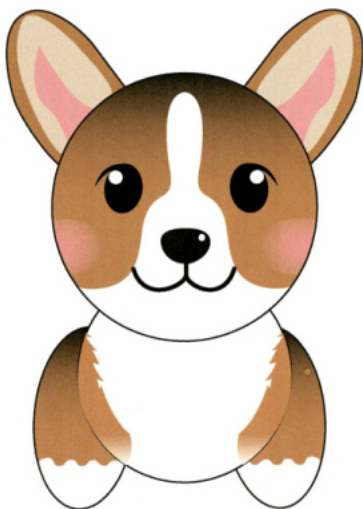

[11] 2422700.9

[15] 17-01-2024

[30] 15-11-2023 / EU / 015041137

[51] Cl. 11-01

[54] 珠寶

Jewellery

[73] FRED PARIS

29 rue des Pyramides,

75001 Paris,

France

[74] LETTERS & THOO LIMITED

Suite 1001-1003, 10/F, Prosperity Millennia Plaza,

663 King's Road,

Quarry Bay, Hong Kong

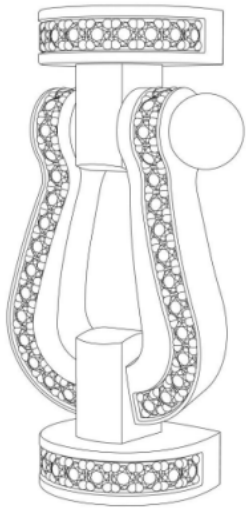

[11] 2422702.3

[15] 18-01-2024

[51] Cl. 22-06

[54] 滅蚊燈

Mosquito killer lamp

[73] 香港霧業有限公司

Hong Kong Misting Limited

香港新界葵青

大連排道 144-150 號

金豐工業大廈第 2 座 25 樓 S 室

[74] 百信企業集團有限公司

香港金鐘

金鐘道 89 號

力寶中心 1 座 10 樓 1003 室



---

[11] 2422703.5M001

[15] 18-01-2024

[30] 01-12-2023 / AM, AZ, BZ, BA, GE, LI, MK, MD, MC, MN, ME, MA,  
NO, OM, RU, SG, CH, TN, TR, UA, GB, EU, AL, KG / DM/233 631

[51] Cl. 10-07

[54] 錶面

Dial

[73] BLANCPAIN SA  
Le Rocher 12,  
CH-1348 Le Brassus,  
Switzerland

[74] SPRUSON & FERGUSON (HONG KONG) LIMITED  
5001 Hopewell Centre,  
183 Queen's Road East,  
Wan Chai, Hong Kong

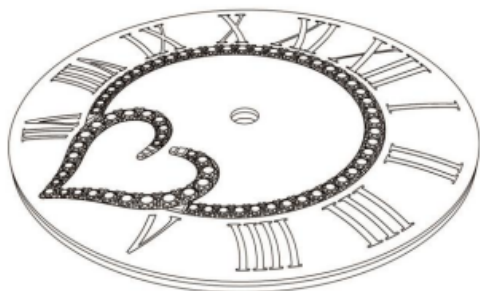

---

[11] 2422703.5M002

[15] 18-01-2024

[30] 01-12-2023 / AM, AZ, BZ, BA, GE, LI, MK, MD, MC, MN, ME, MA,  
NO, OM, RU, SG, CH, TN, TR, UA, GB, EU, AL, KG / DM/233 631

[51] Cl. 10-07

[54] 振動塊

Oscillating mass

[73] BLANCPAIN SA

Le Rocher 12,

CH-1348 Le Brassus,

Switzerland

[74] SPRUSON & FERGUSON (HONG KONG) LIMITED

5001 Hopewell Centre,

183 Queen's Road East,

Wan Chai, Hong Kong



---

[11] 2422704.7

[15] 18-01-2024

[51] Cl. 7-01

[54] 紙杯

Paper cup

[73] 卓榮包裝有限公司

High Win Packaging Limited

香港九龍九龍灣

偉業街 38 號

富臨中心 A 座 18 樓 B 室

[74] 卓遠知識產權有限公司

香港上環

禧利街 27 號

富輝商業中心 10 樓



---

[11] 2422771.8M001

[15] 31-01-2024

[51] Cl. 25-01

[54] 金屬製盲導標示  
Metal tactile marker

[73] 加藍誘導標示有限公司  
Candace Guidance Signage Limited  
香港北角  
蜆殼街 9-23 號  
秀明中心 18 樓 C 室

[74] 加藍誘導標示有限公司  
香港北角  
蜆殼街 9-23 號  
秀明中心 18 樓 C 室

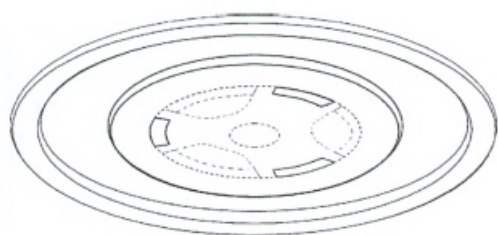

---

[11] 2422771.8M002

[15] 31-01-2024

[51] Cl. 25-01

[54] 金屬製盲導標示  
Metal tactile marker

[73] 加藍誘導標示有限公司  
Candace Guidance Signage Limited  
香港北角  
蜆殼街 9-23 號  
秀明中心 18 樓 C 室

[74] 加藍誘導標示有限公司  
香港北角  
蜆殼街 9-23 號  
秀明中心 18 樓 C 室

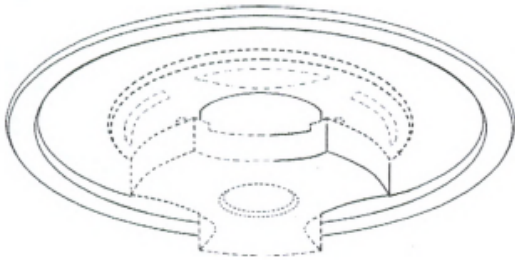

---

[11] 2422771.8M003

[15] 31-01-2024

[51] Cl. 25-01

[54] 金屬製盲導標示  
Metal tactile marker

[73] 加藍誘導標示有限公司  
Candace Guidance Signage Limited  
香港北角  
蜆殼街 9-23 號  
秀明中心 18 樓 C 室

[74] 加藍誘導標示有限公司  
香港北角  
蜆殼街 9-23 號  
秀明中心 18 樓 C 室

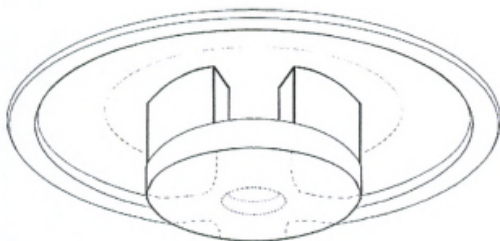

---

[11] 2422771.8M004

[15] 31-01-2024

[51] Cl. 25-01

[54] 金屬製盲導標示

Metal tactile marker

[73] 加藍誘導標示有限公司

Candace Guidance Signage Limited

香港北角

蜆殼街 9-23 號

秀明中心 18 樓 C 室

[74] 加藍誘導標示有限公司

香港北角

蜆殼街 9-23 號

秀明中心 18 樓 C 室

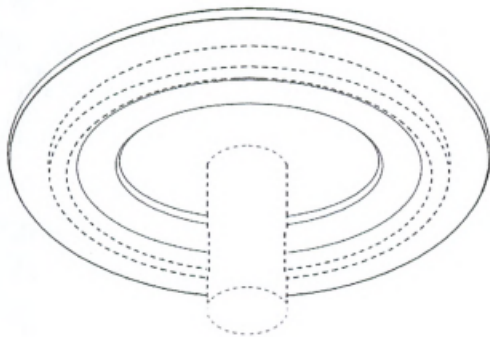

---

[11] 2422844.3M001

[15] 22-02-2024

[30] 19-02-2024 / US / 29/929,056

[51] Cl. 2-02

[54] 馬甲及馬甲的內裡主體

Vest and inner body of vest

[73] 卡拉斯醫療有限公司

Caerus Therapeutics, Inc.

4002 SE 3rd Avenue Cape Coral,

FL 33904,

United States of America

[74] HONG KONG ELITE INTELLECTUAL PROPERTY LIMITED

Room 704, 7/F., Tower A, New Mandarin Plaza,

14 Science Museum Road,

Tsim Sha Tsui East, Kowloon, Hong Kong



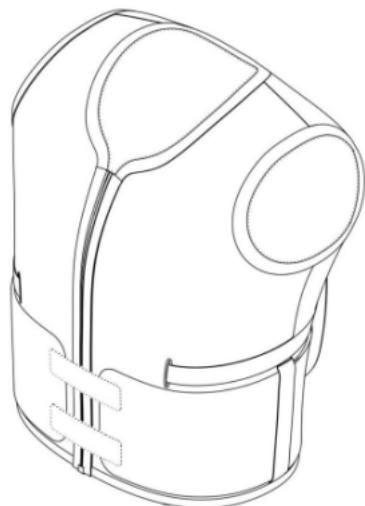

---

[11] 2422844.3M002

[15] 22-02-2024

[30] 19-02-2024 / US / 29/929,056

[51] Cl. 2-02

[54] 馬甲及馬甲的內裡主體

Vest and inner body of vest

[73] 卡拉斯醫療有限公司

Caerus Therapeutics, Inc.

4002 SE 3rd Avenue Cape Coral,

FL 33904,

United States of America

[74] HONG KONG ELITE INTELLECTUAL PROPERTY LIMITED

Room 704, 7/F., Tower A, New Mandarin Plaza,

14 Science Museum Road,

Tsim Sha Tsui East, Kowloon, Hong Kong



- [11] 2422844.3M003  
[15] 22-02-2024  
[30] 22-08-2023 / US / 29/910,600  
[51] Cl. 2-02  
[54] 馬甲及馬甲的內裡主體  
Vest and inner body of vest  
[73] 卡拉斯醫療有限公司  
Caerus Therapeutics, Inc.  
4002 SE 3rd Avenue Cape Coral,  
FL 33904,  
United States of America  
[74] HONG KONG ELITE INTELLECTUAL PROPERTY LIMITED  
Room 704, 7/F., Tower A, New Mandarin Plaza,  
14 Science Museum Road,  
Tsim Sha Tsui East, Kowloon, Hong Kong



- 
- [11] 2422871.0  
[15] 01-03-2024  
[51] Cl. 9-03  
[54] 包裝盒  
Packaging box  
[73] 鴻運貿易(國際)有限公司  
HUNG WIN TRADING COMPANY LIMITED  
香港葵涌  
打磚坪街 44-52 號  
達明工業大廈 5 樓, A, A2, A3, A4, A5 室  
[74] 鴻運貿易(國際)有限公司 (HUNG WIN TRADING COMPANY LIMITED)  
香港葵涌

打磚坪街 44-52 號

達明工業大廈 5 樓, A, A2, A3, A4, A5 室



[11] 2422874.6

[15] 01-03-2024

[51] C1. 21-01

[54] 公仔

Doll

[73] 盧瀚霆國際後援會有限公司

AnsonLohonting International Fan Club Limited  
Rm 1401E, 14/F., Wing Shing Industrial Building,  
26 Ng Fong Street,  
San Po Kong, Kowloon, Hong Kong

[74] DIAMI INTELLECTUAL PROPERTY COMPANY LIMITED

Unit 1102, 11/F.,  
88 Gloucester Road,  
Wanchai, Hong Kong



---

[11] 2422875.9M001

[15] 01-03-2024

[51] Cl. 20-03

Cl. 20-02

[54] 用於櫥窗、招牌及陳列設備的圖案

Pattern for shop window, signboard and display unit

[73] 周生生珠寶金行有限公司

Chow Sang Sang Jewellery Company Limited

4/F, Chow Sang Sang Building,

229 Nathan Road,

Kowloon, Hong Kong

[74] DORSEY & WHITNEY

Room 2802, 28th Floor, Alexandra House,

18 Chater Road,

Hong Kong



---

[11] 2422875.9M002

[15] 01-03-2024

[51] Cl. 20-03

Cl. 20-02

[54] 用於櫥窗、招牌及陳列設備的圖案

Pattern for shop window, signboard and display unit

[73] 周生生珠寶金行有限公司  
Chow Sang Sang Jewellery Company Limited  
4/F, Chow Sang Sang Building,  
229 Nathan Road,  
Kowloon, Hong Kong

[74] DORSEY & WHITNEY  
Room 2802, 28th Floor, Alexandra House,  
18 Chater Road,  
Hong Kong



---

[11] 2422875.9M003

[15] 01-03-2024

[51] Cl. 20-03

Cl. 20-02

[54] 用於櫥窗、招牌及陳列設備的圖案  
Pattern for shop window, signboard and display unit

[73] 周生生珠寶金行有限公司  
Chow Sang Sang Jewellery Company Limited  
4/F, Chow Sang Sang Building,  
229 Nathan Road,  
Kowloon, Hong Kong

[74] DORSEY & WHITNEY  
Room 2802, 28th Floor, Alexandra House,  
18 Chater Road,  
Hong Kong

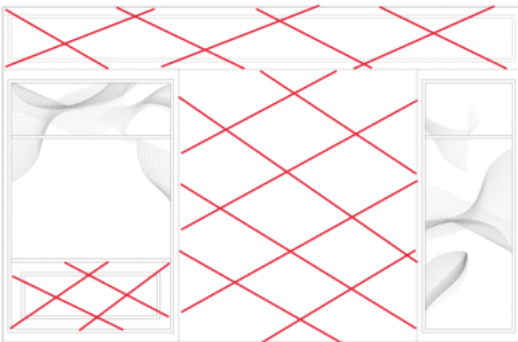

- [11] 2422876.1M001
- [15] 01-03-2024
- [51] Cl. 20-03  
Cl. 20-02
- [54] 用於指示牌及陳列設備的圖案  
Pattern for signboard display and display unit
- [73] 周生生珠寶金行有限公司  
Chow Sang Sang Jewellery Company Limited  
4/F, Chow Sang Sang Building,  
229 Nathan Road,  
Kowloon, Hong Kong
- [74] DORSEY & WHITNEY  
Room 2802, 28th Floor, Alexandra House,  
18 Chater Road,  
Hong Kong

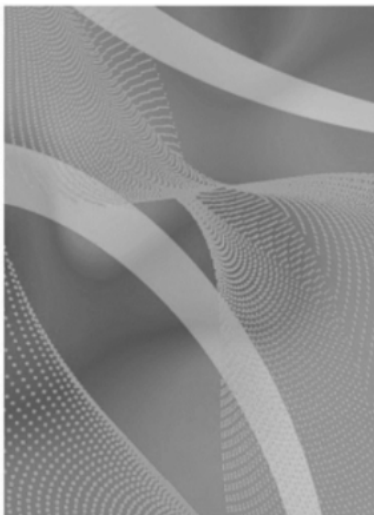

- 
- [11] 2422876.1M002
- [15] 01-03-2024
- [51] Cl. 20-03  
Cl. 20-02
- [54] 用於指示牌及陳列設備的圖案  
Pattern for signboard display and display unit
- [73] 周生生珠寶金行有限公司  
Chow Sang Sang Jewellery Company Limited  
4/F, Chow Sang Sang Building,  
229 Nathan Road,  
Kowloon, Hong Kong
- [74] DORSEY & WHITNEY  
Room 2802, 28th Floor, Alexandra House,  
18 Chater Road,  
Hong Kong



---

[11] 2422876.1M003

[15] 01-03-2024

[51] Cl. 20-03

Cl. 20-02

[54] 用於指示牌及陳列設備的圖案

Pattern for signboard display and display unit

[73] 周生生珠寶金行有限公司

Chow Sang Sang Jewellery Company Limited

4/F, Chow Sang Sang Building,

229 Nathan Road,

Kowloon, Hong Kong

[74] DORSEY & WHITNEY

Room 2802, 28th Floor, Alexandra House,

18 Chater Road,

Hong Kong

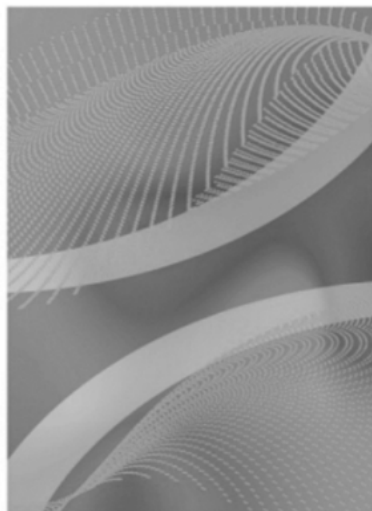

[11] 2422879.7M001

[15] 04-03-2024

[51] Cl. 21-01

[54] 玩偶

Doll

[73] 香港理工大學

THE HONG KONG POLYTECHNIC UNIVERSITY

香港

九龍紅磡

育才道 11 號

[74] 中一聯合國際知識產權有限公司

香港九龍尖沙咀

漆咸道南 45-51 號

其士大廈 803 室



---

[11] 2422879.7M002

[15] 04-03-2024

[51] Cl. 21-01

[54] 玩偶

Doll

[73] 香港理工大學

THE HONG KONG POLYTECHNIC UNIVERSITY

香港

九龍紅磡

育才道 11 號

[74] 中一聯合國際知識產權有限公司

香港九龍尖沙咀



漆咸道南 45-51 號

其士大廈 803 室



[11] 2422880.9

[15] 04-03-2024

[30] 20-09-2023 / EU / 015034586-0001

[51] Cl. 8-06

[54] 帶安全鎖的門把手

Door handle with security lock

[73] Abloy Oy

Wahlforssinkatu 20,

FI-80100 Joensuu,

Finland

[74] CHINA PATENT AGENT (HONG KONG) LIMITED

22/F, Great Eagle Centre,

23 Harbour Road,

Wanchai, Hong Kong



- [11] 2422882.3  
[15] 04-03-2024  
[30] 19-09-2023 / KR / 30-2023-0037079  
[51] Cl. 23-04  
[54] 空氣清新機  
Air purifier  
[73] LG Jeon za Joo-sik-hoi-sa (LG Electronics Inc.)  
128, Yeoui-daero,  
Yeongdeungpo-gu, Seoul, 07336,  
Republic of Korea  
[74] SPRUSON & FERGUSON (HONG KONG) LIMITED  
5001 Hopewell Centre,  
183 Queen's Road East,  
Wan Chai, Hong Kong



- 
- [11] 2422883.5  
[15] 04-03-2024  
[30] 26-09-2023 / KR / 30-2023-0038295  
[51] Cl. 23-04  
[54] 空氣清新機  
Air purifier  
[73] LG Jeon za Joo-sik-hoi-sa (LG Electronics Inc.)  
128, Yeoui-daero,  
Yeongdeungpo-gu, Seoul, 07336,  
Republic of Korea  
[74] SPRUSON & FERGUSON (HONG KONG) LIMITED  
5001 Hopewell Centre,  
183 Queen's Road East,  
Wan Chai, Hong Kong



---

[11] 2422884.7M001

[15] 04-03-2024

[51] Cl. 21-01

[54] 玩具夢幻島

Toy fantasy land

[73] 集美塑膠玩具製品廠有限公司

Chap Mei Plastic Toys Manufactory Limited

Unit 541, 5/F., Sino Industrial Plaza,

9 Kai Cheung Road,

Kowloon Bay, Kowloon, Hong Kong

[74] BENNY KONG & TSAI

Unit 19B, Overseas Trust Bank Building,

No. 160 Gloucester Road,

Wanchai, Hong Kong



- [11] 2422884.7M002  
[15] 04-03-2024  
[51] Cl. 21-01  
[54] 玩具警車  
Toy police car  
[73] 集美塑膠玩具製品廠有限公司  
Chap Mei Plastic Toys Manufactory Limited  
Unit 541, 5/F., Sino Industrial Plaza,  
9 Kai Cheung Road,  
Kowloon Bay, Kowloon, Hong Kong  
[74] BENNY KONG & TSAI  
Unit 19B, Overseas Trust Bank Building,  
No. 160 Gloucester Road,  
Wanchai, Hong Kong



- 
- [11] 2422885.0  
[15] 05-03-2024  
[51] Cl. 1-99  
[54] 固體食品  
Solid food  
[73] 峰鎧食品科技有限公司  
Goolab Technology Company Limited  
Rm 1805-06, 18/F, Hollywood Plaza,  
610 Nathan Road,  
Mong Kok, Hong Kong  
[74] 峰鎧食品科技有限公司  
Rm 1805-06, 18/F, Hollywood Plaza,  
610 Nathan Road,  
Mong Kok, Hong Kong

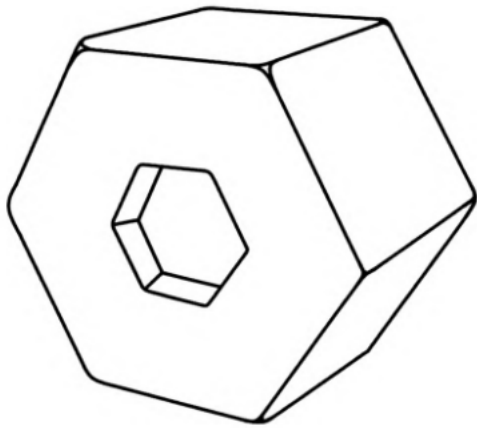

---

[11] 2422886.2

[15] 05-03-2024

[30] 09-10-2023 / EU / 015036611-0002

[51] Cl. 9-03

[54] 化妝品盒子(包裝用)

Boxes for cosmetics (packaging)

[73] GUERLAIN

68 Avenue des Champs-Élysées,

75008 Paris,

France

[74] WENPING PATENT & TRADE MARK AGENT LIMITED

1701 Tung Wai Commercial Building,

111 Gloucester Road,

Hong Kong



---

[11] 2422887.4

- [15] 05-03-2024
- [30] 29-09-2023 / IT / 402023000002604
- [51] Cl. 2-04
- [54] 鞋子  
Shoe
- [73] VALENTINO S.p.A.  
Via Turati, 16/18,  
I-20121 Milano,  
Italy
- [74] KSK IP AGENCY LIMITED  
Flat/Rm 1602A, 16/F,  
Causeway Bay Commercial Bldg,  
3 Sugar Street, Causeway Bay, Hong Kong

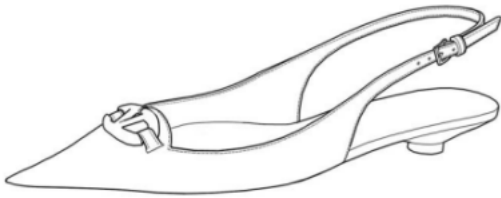

- 
- [11] 2422889.8
- [15] 05-03-2024
- [51] Cl. 11-01
- [54] 鏈子鎖扣  
Chain clasp
- [73] 深圳市華悅珠寶科技有限公司  
中國深圳市鹽田區  
沙頭角街道田心社區深鹽路 3051 號  
龍嘉首飾一棟 2 層及 3 層 302 房
- [74] 天標知識產權代理有限公司  
香港九龍尖沙咀  
加連威老道 14 號  
加連威大廈 4 樓 A 座



---

[11] 2422892.4

[15] 05-03-2024

[51] Cl. 11-01

[54] 鏈子鎖扣

Chain clasp

[73] 深圳市華悅珠寶科技有限公司

中國深圳市鹽田區

沙頭角街道田心社區深鹽路 3051 號

龍嘉首飾一棟 2 層及 3 層 302 房

[74] 天標知識產權代理有限公司

香港九龍尖沙咀

加連威老道 14 號

加連威大廈 4 樓 A 座



- [11] 2422896.3  
[15] 06-03-2024  
[51] Cl. 11-01  
[54] 戒指  
Ring  
[73] Liu Ka Wan Karen  
Room A, 17/F, Man Hing Commercial Building,  
79-83 Queen's Road Central,  
Hong Kong  
[74] TRADEMARKCN COMPANY LIMITED  
Block A, 4/F., Granville Building,  
14 Granville Road,  
Tsim Sha Tsui, Kowloon, Hong Kong



- 
- [11] 2422899.9  
[15] 06-03-2024  
[30] 06-09-2023 / GB / 6308224  
[51] Cl. 28-06  
[54] 頭髮造型和頭髮護理裝置(的附件)  
Hair styling and hair care apparatus (accessories for-)  
[73] Dyson Technology Limited  
Tetbury Hill, Malmesbury,  
Wiltshire, SN16 0RP,  
United Kingdom  
[74] LIU, SHEN & ASSOCIATES  
Room 3716, 37/F, Sun Hung Kai Centre,  
30 Harbour Road,  
Wanchai, Hong Kong



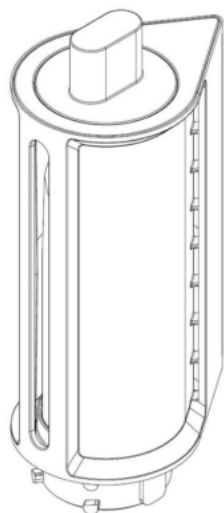

---

[11] 2422902.7

[15] 07-03-2024

[51] Cl. 14-03

[54] 用於無線數據通信的天線

Antenna for wireless data communication

[73] PISMO LABS TECHNOLOGY LIMITED

Unit A8, Floor 5,

Hong Kong Spinners Industrial Building (Phase 6),

481 Castle Peak Road,

Cheung Sha Wan, Hong Kong

[74] Cherrie Chiu

Unit A8, Floor 5,

Hong Kong Spinners Industrial Building (Phase 6),

481 Castle Peak Road,

Cheung Sha Wan, Hong Kong

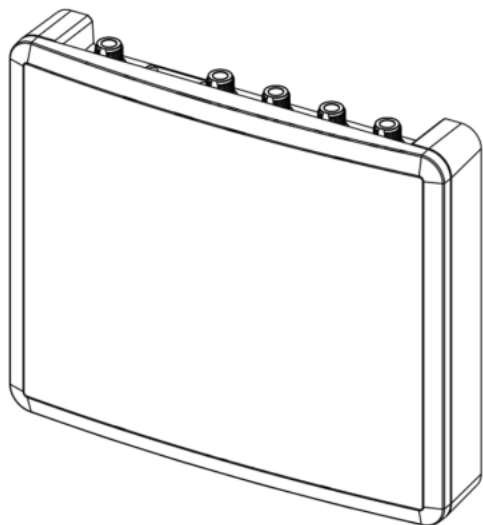

[11] 2422903.9

[15] 07-03-2024

[51] Cl. 14-03

[54] 用於無線數據通信的天線

Antenna for wireless data communication

[73] PISMO LABS TECHNOLOGY LIMITED

Unit A8, Floor 5,

Hong Kong Spinners Industrial Building (Phase 6),

481 Castle Peak Road,

Cheung Sha Wan, Hong Kong

[74] Cherrie Chiu

Unit A8, Floor 5,

Hong Kong Spinners Industrial Building (Phase 6),

481 Castle Peak Road,

Cheung Sha Wan, Hong Kong

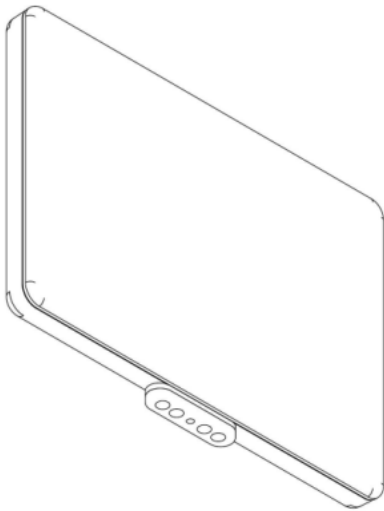

---

[11] 2422904.1M001

[15] 07-03-2024

[51] Cl. 14-03

[54] 用於無線數據通信的天線

Antenna for wireless data communication

[73] PISMO LABS TECHNOLOGY LIMITED

Unit A8, Floor 5,

Hong Kong Spinners Industrial Building (Phase 6),

481 Castle Peak Road,

Cheung Sha Wan, Hong Kong

[74] Cherrie Chiu

Unit A8, Floor 5,

Hong Kong Spinners Industrial Building (Phase 6),

481 Castle Peak Road,

Cheung Sha Wan, Hong Kong

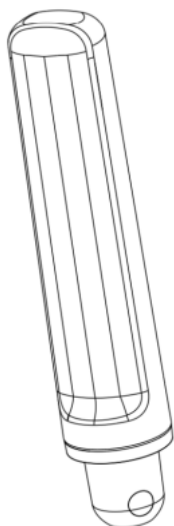

---

[11] 2422904.1M002

[15] 07-03-2024

[51] Cl. 14-03

[54] 用於無線數據通信的天線

Antenna for wireless data communication

[73] PISMO LABS TECHNOLOGY LIMITED

Unit A8, Floor 5,

Hong Kong Spinners Industrial Building (Phase 6),

481 Castle Peak Road,

Cheung Sha Wan, Hong Kong

[74] Cherrie Chiu

Unit A8, Floor 5,

Hong Kong Spinners Industrial Building (Phase 6),

481 Castle Peak Road,

Cheung Sha Wan, Hong Kong

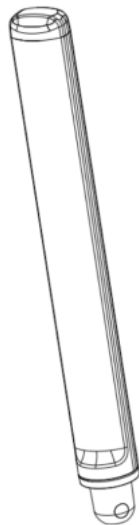

[11] 2422905.4

[15] 07-03-2024

[51] Cl. 7-04

[54] 咖啡研磨機  
Coffee grinder

[73] 玻璃王株式會社  
HARIO Co., Ltd.  
9-3, Nihonbashi Tomizawa-Cho,  
Chuo-Ku, Tokyo 103-0006,  
Japan

[74] CHINA PATENT AGENT (HONG KONG) LIMITED  
22/F, Great Eagle Centre,  
23 Harbour Road,  
Wanchai, Hong Kong

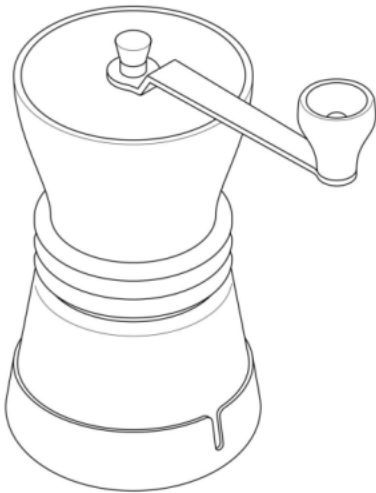

---

[11] 2422936.9

[15] 12-03-2024

[30] 27-02-2024 / JP / 2024-003912

[51] Cl. 21-03

[54] 遊戲機  
Game machine

[73] 株式會社萬代  
BANDAI CO., LTD.  
4-8, Komagata 1-chome,  
Taito-ku, Tokyo,  
Japan

[74] 范紀羅江律師行  
香港灣仔  
港灣道 6-8 號  
瑞安中心 23 樓

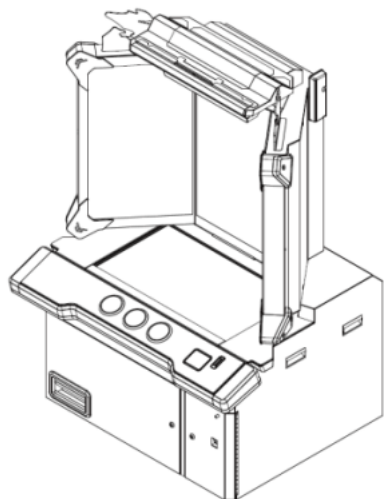



香港特別行政區政府知識產權署外觀設計註冊處  
The Government of the Hong Kong Special Administrative Region  
Designs Registry, Intellectual Property Department

根據註冊外觀設計條例第 28 條，下列註冊外觀設計因未繳續期費而停止有效。

各組記項按註冊外觀設計停止有效日期及註冊編號先後次序排列。

**Registered designs ceased through non-payment of renewal fees under section 28 of the Registered Designs Ordinance. Entries are listed below under their expiry dates.**

**14-03-2024 - 19-03-2024**

<b>14-03-2024</b>	1400470.1M009	0410626.4M003
0410570.4M001	1400470.1M010	0410629.0
0410570.4M002	1400471.3M001	1913237.8
0410570.4M003	1400471.3M002	1913240.4
1913204.8	1400471.3M003	1913241.6
1913208.7	1400471.3M004	1913243.0
1913213.7	1400472.5M001	1913246.7
1913214.9M001	1400472.5M002	1913247.9
1913214.9M002	1400472.5M003	
1913214.9M003	1400472.5M004	<b>19-03-2024</b>
1913214.9M004	1400472.5M005	0900445.2M001
1913214.9M005	1400473.7	0900445.2M002
1913214.9M006	1400474.9	1400503.3
1913214.9M007	1400475.2	1913252.9M001
1913214.9M008	1400476.4	1913252.9M002
1913214.9M009	1400477.6	1913252.9M003
1913214.9M010		1913253.1M001
1913214.9M011	<b>17-03-2024</b>	1913253.1M002
1913219.0M001	0900424.7	1913254.3
1913220.2M001	0900433.6	
1913220.2M002	1400479.0	
	1400480.2M001	
<b>16-03-2024</b>	1400480.2M002	
0900411.0	1400483.8	
0900412.2	1400484.0	
1400469.9M001	1400485.3	
1400469.9M002	1913227.7	
1400470.1M001	1913230.3	
1400470.1M002	1913231.5	
1400470.1M003	1913232.7	
1400470.1M005		
1400470.1M006	<b>18-03-2024</b>	
1400470.1M007	0410626.4M001	
1400470.1M008	0410626.4M002	



香港特別行政區政府知識產權署外觀設計註冊處  
The Government of the Hong Kong Special Administrative Region  
Designs Registry, Intellectual Property Department

根據註冊外觀設計規則第 31 條刪除的註冊外觀設計。各組記項按註冊外觀設計刪除日期及註冊編號先後次序排列。

**Registered designs removed under section 31 of the Registered Designs Rules. Entries are listed below under their removal dates.**

**22-03-2024 - 27-03-2024**

<b>22-03-2024</b>	1801907.5
0311520.9	1801908.7
0311521.1	1801909.9
	1801910.1
<b>23-03-2024</b>	1801911.3
0802239.6	1801912.5

**24-03-2024**

0311532.4  
0802248.5  
0802253.5M001  
0802253.5M002  
0802253.5M003  
0802253.5M004  
0802253.5M005  
0802253.5M006  
0802253.5M007  
1301600.9M001  
1301600.9M005  
1301600.9M006  
1801896.0M001  
1801896.0M002  
1801896.0M003  
1801899.6  
1801900.0

**26-03-2024**

1301623.7M001  
1301623.7M002  
1301623.7M003  
1301623.7M004  
1801914.9  
1801917.6  
1801918.8

**27-03-2024**

1801922.6  
1801923.8  
1801924.0  
1801927.7  
1801928.9  
1801930.3  
1801931.5M001  
1801931.5M002  
1801931.5M003  
1801931.5M004  
1801931.5M005

**25-03-2024**

0802268.7  
1301609.8  
1801903.6  
1801905.1  
1801906.3M001  
1801906.3M002  
1801906.3M003