

香港知識產權公報

Hong Kong Intellectual Property Journal

2024年9月13日
13 September 2024



目錄 Contents

根據註冊外觀設計條例第 25 條註冊的外觀設計

Designs Registered under section 25 of the Registered Designs Ordinance

按註冊編號排列

Arranged by Registration Number

根據註冊外觀設計條例(第 522 章)公布的其他公告

Other Notices Published under the Registered Designs Ordinance (Cap. 522)

根據註冊外觀設計條例第 28 條，註冊外觀設計因未繳續期費而停止有效

Registered designs ceased through non-payment of renewal fees under section 28 of the Registered Designs Ordinance

根據註冊外觀設計規則第 31 條刪除的註冊外觀設計

Registered designs removed under section 31 of the Registered Designs Rules

勘誤

Corrigendum

以下事項沒有記錄

No Records for the Following Matters

根據註冊外觀設計條例第 30 條放棄的外觀設計的註冊

Surrender of Registration of Design under section 30 of the Registered Designs Ordinance

根據註冊外觀設計規則第 37 條，向處長作出轉介

Reference to Registrar under section 37 of the Registered Designs Rules

根據註冊外觀設計條例第 45 條，撤銷註冊

Revocation of Registration under section 45 of the Registered Designs Ordinance

根據註冊外觀設計規則第 46 條，向法院作出轉介

Reference to Court under section 46 of the Registered Designs Rules

根據註冊外觀設計規則第 63 條對不符合規定之處作出糾正

Rectification of Irregularities under section 63 of the Registered Designs Rules

根據註冊外觀設計條例第 66 條，糾正註冊紀錄冊

Rectification of Register under section 66 of the Registered Designs Ordinance

根據註冊外觀設計條例第 67 條 更正註冊紀錄冊內的錯誤

Correction of errors in Register under section 67 of the Registered Designs Ordinance

根據註冊外觀設計條例第 67 及 76 條，更正註冊紀錄冊內及已提交文件中的錯誤

Correction of Errors in Register and in Filed Documents under sections 67 and 76 of the Registered Designs Ordinance

根據註冊外觀設計條例第 76 條，更正已提交文件中的錯誤

Correction of errors in filed documents under section 76 of the Registered Designs Ordinance

註冊外觀設計公告註釋

Notes on advertisements of registration of designs

方括號表示下列資料：

Square brackets indicate the following data：

[11] 註冊編號 Registration number / 聯合王國註冊編號 United Kingdom registration number

[15] 註冊日期 Registration date / 當作註冊日期 Deemed registration date / 聯合王國註冊日期 United Kingdom registration date

[17] 註冊有效期屆滿日期 Expiry date of the period of registration

[22] 提交日期 Filing date / 當作提交日期 Deemed filing date / 聯合王國提交日期 United Kingdom filing date

[30] 聲稱享有的優先權（提交日期 / 巴黎公約國或世界貿易組織成員 / 申請編號） Priority claimed (filing date / Paris Convention country or WTO member / application number)

[51] 國際外觀設計分類號（洛迦諾分類號） International Classification of designs (Locarno Classification)

[54] 物品 Article

[55] 外觀設計的表述 Representation of the design

[62] 分開前的申請編號及提交日期 Application number before division and filing date

[66] 過往註冊的聯繫外觀設計註冊編號 / 日期 Registration No. / Date of Previous Registration for Association

[72] 設計人 Designer

[73] 擁有人姓名和地址 Name and address of the owner

[74] 代理人 Agent /送達地址 Address for service



香港特別行政區政府知識產權署外觀設計註冊處

The Government of the Hong Kong Special Administrative Region

Designs Registry, Intellectual Property Department

根據註冊外觀設計條例第 25 條註冊的外觀設計

Designs registered under section 25 of the Registered Designs Ordinance

按註冊編號排列

Arranged by Registration Number

[11] 2322322.5

[15] 09-11-2023

[30] 10-05-2023 / EU / 015021044-0001

[51] Cl. 31-00

[54] 製備飲料的機器

Machine for preparing drink

[73] BEABA

37 Rue de Liège,

75008 Paris,

France

[74] DEACONS

5th Floor, Alexandra House,

Central,

Hong Kong

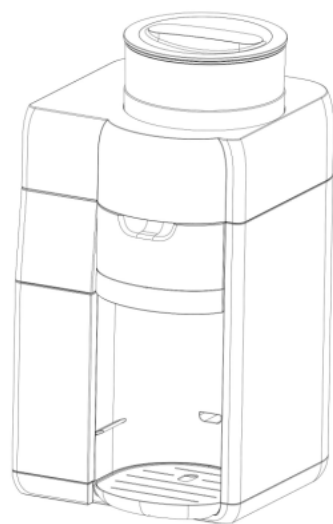

[11] 2423215.1

[15] 24-04-2024

[51] Cl. 11-01

[54] 吊咀
Pendant

[73] 蒂廷國際有限公司
香港
九龍紅磡民裕街 41 號
凱旋工商中心 1 期 1 樓 A3 室

[74] 蒂廷國際有限公司
香港
九龍紅磡民裕街 41 號
凱旋工商中心 1 期 1 樓 A3 室



[11] 2423293.4

[15] 10-05-2024

[51] Cl. 10-02

[54] 背囊掛錶
Backpacker watch

[73] 卓時企業有限公司
KEYTIME ENTERPRISES LIMITED
Room 903, Sunray Industrial Centre,
610 Cha Kwo Ling Road,
Hong Kong

[74] Fan Wai Man Raymond
Room 903, Sunray Industrial Centre,
610 Cha Kwo Ling Road, Yau Tong,
Hong Kong



-
- [11] 2423299.7
[15] 10-05-2024
[30] 17-04-2024 / CN / 2024302154348
[51] Cl. 25-02
[54] 施工防護欄
Guardrail for construction
[73] 祥峰五金貿易有限公司
CHEUNG FUNG METAL TRADING COMPANY LIMITED
香港新界
八鄉錦田公路 DD111, LOT2161
[74] 卓遠知識產權有限公司
香港
上環禧利街 27 號
富輝商業中心 10 樓



-
- [11] 2423300.1M001
[15] 11-05-2024
[30] 11-11-2023 / TR / 2023/011439
[51] Cl. 6-06

[54] 乘客座椅的頭枕

Headrest for passenger seat

[73] VOGELSITZE KOLTUK SISTEMLERI Sanayi Ve Ticaret A.S.

Fethiye OSB Mah. Ali Osman Sönmez,
Bulvari 2. Sokak No: 1, Nilüfer/Bursa,
Turkey

[74] I-MARK INTELLECTUAL PROPERTY CO., LIMITED

Unit B11, 21/F, Tak Wing Industrial Building,
No. 3 Tsun Wen Road, Tuen Mun,
New Territories, Hong Kong

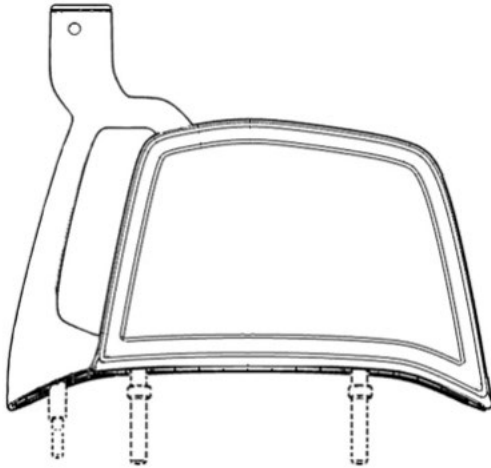

[11] 2423300.1M002

[15] 11-05-2024

[30] 11-11-2023 / TR / 2023/011439

[51] Cl. 6-06

[54] 乘客座椅的頭枕

Headrest for passenger seat

[73] VOGELSITZE KOLTUK SISTEMLERI Sanayi Ve Ticaret A.S.

Fethiye OSB Mah. Ali Osman Sönmez,
Bulvari 2. Sokak No: 1, Nilüfer/Bursa,
Turkey

[74] I-MARK INTELLECTUAL PROPERTY CO., LIMITED

Unit B11, 21/F, Tak Wing Industrial Building,
No. 3 Tsun Wen Road, Tuen Mun,
New Territories, Hong Kong



[11] 2423300.1M003

[15] 11-05-2024

[30] 11-11-2023 / TR / 2023/011439

[51] Cl. 6-06

[54] 乘客座椅的頭枕

Headrest for passenger seat

[73] VOGELSITZE KOLTUK SISTEMLERI Sanayi Ve Ticaret A.S.

Fethiye OSB Mah. Ali Osman Sönmez,

Bulvari 2. Sokak No: 1, Nilüfer/Bursa,

Turkey

[74] I-MARK INTELLECTUAL PROPERTY CO., LIMITED

Unit B11, 21/F, Tak Wing Industrial Building,

No. 3 Tsun Wen Road, Tuen Mun,

New Territories, Hong Kong



- [11] 2423300.1M004
[15] 11-05-2024
[30] 11-11-2023 / TR / 2023/011439
[51] Cl. 6-01
[54] 乘客座椅
Passenger seat
[73] VOGELSITZE KOLTUK SISTEMLERI Sanayi Ve Ticaret A.S.
Fethiye OSB Mah. Ali Osman Sönmez,
Bulvari 2. Sokak No: 1, Nilüfer/Bursa,
Turkey
[74] I-MARK INTELLECTUAL PROPERTY CO., LIMITED
Unit B11, 21/F, Tak Wing Industrial Building,
No. 3 Tsun Wen Road, Tuen Mun,
New Territories, Hong Kong



-
- [11] 2423300.1M005
[15] 11-05-2024
[30] 11-11-2023 / TR / 2023/011439
[51] Cl. 6-06
[54] 乘客座椅的頭枕
Headrest for passenger seat
[73] VOGELSITZE KOLTUK SISTEMLERI Sanayi Ve Ticaret A.S.
Fethiye OSB Mah. Ali Osman Sönmez,
Bulvari 2. Sokak No: 1, Nilüfer/Bursa,
Turkey
[74] I-MARK INTELLECTUAL PROPERTY CO., LIMITED
Unit B11, 21/F, Tak Wing Industrial Building,
No. 3 Tsun Wen Road, Tuen Mun,
New Territories, Hong Kong

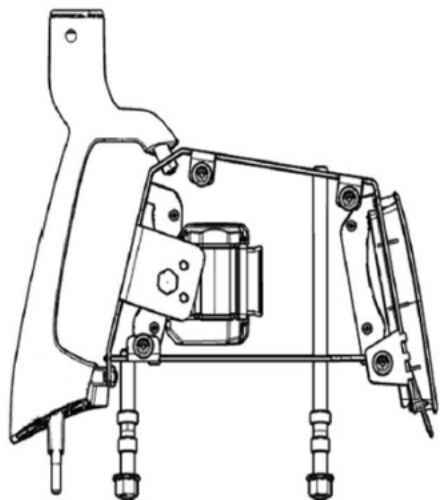

[11] 2423314.0M001

[15] 14-05-2024

[30] 15-11-2023 / EU / 015041065-0001

[51] Cl. 28-03

[54] 按摩儀的按摩頭

Head for massage apparatus

[73] LPG SYSTEMS

30, rue Docteur Henri Abel,

F-26000 Valence,

France

[74] WAN HUI DA (ASIA PACIFIC) CONSULTING LIMITED

Suite 1903, Central Plaza,

18 Harbour Road,

Hong Kong



- [11] 2423314.0M002
- [15] 14-05-2024
- [30] 15-11-2023 / EU / 015041068-0001
- [51] Cl. 28-03
- [54] 按摩儀
Massage apparatus
- [73] LPG SYSTEMS
30, rue Docteur Henri Abel,
F-26000 Valence,
France
- [74] WAN HUI DA (ASIA PACIFIC) CONSULTING LIMITED
Suite 1903, Central Plaza,
18 Harbour Road,
Hong Kong

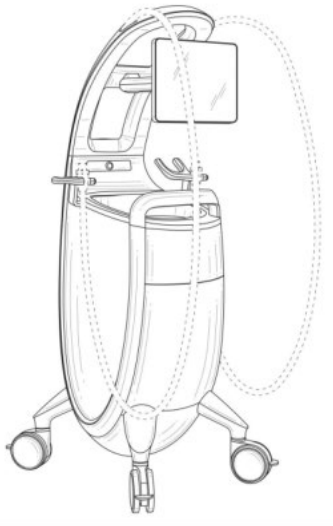

- [11] 2423362.1
- [15] 22-05-2024
- [51] Cl. 14-04
- [54] 顯示屏幕面板的股票走勢分析圖形用戶界面
Graphical user interface for stock trends analysis of the
display screen panel
- [73] 深圳市富途網絡科技有限公司
中國
廣東省深圳市南山區粵海街道科技園社區
科苑路 15 號科興科學園 D1 棟 25 層, 518000
- [74] 港智國際知識產權代理有限公司
香港
屯門震寰路 3 號
德榮工業大廈 21 字樓 B11 室



[11] 2423363.3

[15] 22-05-2024

[51] C1. 14-04

[54] 電子設備的功能訪問圖形用戶界面

Graphical user interface for accessing functions of electronic device

[73] 深圳市富途網絡科技有限公司

中國

廣東省深圳市南山區粵海街道科技園社區

科苑路 15 號科興科學園 D1 棟 25 層，518000

[74] 港智國際知識產權代理有限公司

香港

屯門震寰路 3 號

德榮工業大廈 21 字樓 B11 室

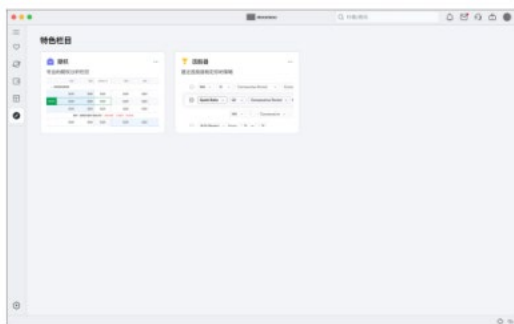

[11] 2423364.5

[15] 22-05-2024

[51] C1. 14-04

[54] 電子設備的股票管理圖形用戶界面

Graphical user interface for stock management of electronic device

[73] 深圳市富途網絡科技有限公司
中國
廣東省深圳市南山區粵海街道科技園社區
科苑路 15 號科興科學園 D1 棟 25 層，518000

[74] 港智國際知識產權代理有限公司
香港
屯門震寰路 3 號
德榮工業大廈 21 字樓 B11 室

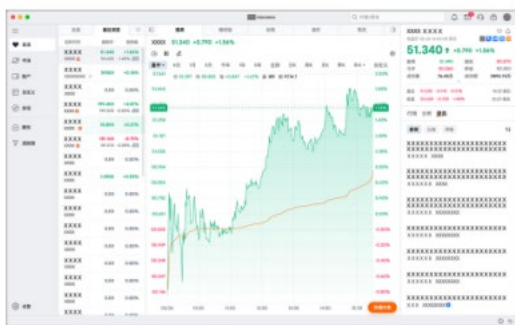

[11] 2423378.5

[15] 24-05-2024

[51] Cl. 7-01

[54] 飲用容器用蓋
Lid for drinking vessels

[73] 頌怡香港有限公司
Joinease Hong Kong Limited
Flat 19, 13/F., Leader Industrial Centre,
57-59 Au Pui Wan Street, Fo Tan, New Territories,
Hong Kong

[74] FEDERATION OF HONG KONG INDUSTRIES
31/F, Billion Plaza,
8 Cheung Yue Street, Cheung Sha Wan, Kowloon,
Hong Kong

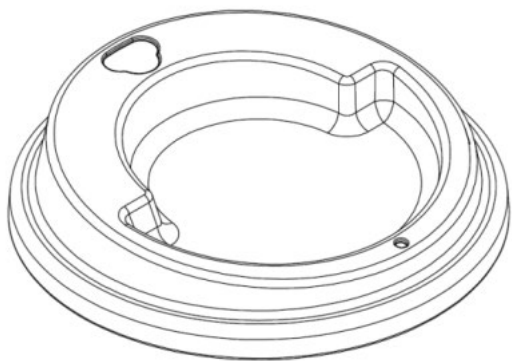

- [11] 2423385.0
[15] 24-05-2024
[30] 06-12-2023 / IT / 402023000003525
[51] Cl. 2-04
[54] 鞋
Shoe
[73] VALENTINO S.p.A.
Via Turati, 16/18,
I-20121 MILANO,
ITALY
[74] BIRD & BIRD
6/F, The Annex, Central Plaza,
18 Harbour Road,
Hong Kong



-
- [11] 2423448.4
[15] 04-06-2024
[51] Cl. 11-01
[54] 手鏈
Bracelet
[73] 蒂廷國際有限公司
香港
九龍紅磡民裕街 41 號
凱旋工商中心一期一樓, A3 室
[74] 蒂廷國際有限公司
香港
九龍紅磡民裕街 41 號
凱旋工商中心一期一樓, A3 室



[11] 2423454.6

[15] 04-06-2024

[51] Cl. 11-01

[54] 吊咀
Pendant

[73] 蒂廷國際有限公司
香港
九龍紅磡民裕街 41 號
凱旋工商中心一期一樓, A3 室

[74] 蒂廷國際有限公司
香港
九龍紅磡民裕街 41 號
凱旋工商中心一期一樓, A3 室



[11] 2423455.9

[15] 04-06-2024

[51] Cl. 11-01

[54] 吊咀
Pendant

[73] 蒂廷國際有限公司
香港
九龍紅磡民裕街 41 號
凱旋工商中心一期一樓, A3 室

[74] 蒂廷國際有限公司
香港
九龍紅磡民裕街 41 號
凱旋工商中心一期一樓, A3 室



[11] 2423456.1

[15] 04-06-2024

[51] Cl. 11-01

[54] 吊咀
Pendant

[73] 蒂廷國際有限公司
香港
九龍紅磡民裕街 41 號
凱旋工商中心一期一樓, A3 室

[74] 蒂廷國際有限公司
香港
九龍紅磡民裕街 41 號
凱旋工商中心一期一樓, A3 室



[11] 2423457.3

[15] 04-06-2024

[51] Cl. 11-01

[54] 吊咀
Pendant

[73] 蒂廷國際有限公司
香港
九龍紅磡民裕街 41 號
凱旋工商中心一期一樓, A3 室

[74] 蒂廷國際有限公司
香港
九龍紅磡民裕街 41 號
凱旋工商中心一期一樓, A3 室



[11] 2423458.5

[15] 04-06-2024

[51] Cl. 11-01

[54] 戒指
Ring

[73] 蒂廷國際有限公司
香港
九龍紅磡民裕街 41 號
凱旋工商中心一期一樓，A3 室

[74] 蒂廷國際有限公司
香港
九龍紅磡民裕街 41 號
凱旋工商中心一期一樓，A3 室



[11] 2423459.7

[15] 04-06-2024

[51] Cl. 11-01

[54] 戒指
Ring

[73] 蒂廷國際有限公司
香港
九龍紅磡民裕街 41 號
凱旋工商中心一期一樓，A3 室

[74] 蒂廷國際有限公司
香港
九龍紅磡民裕街 41 號
凱旋工商中心一期一樓，A3 室



[11] 2423460.9

[15] 04-06-2024

[51] Cl. 11-01

[54] 戒指
Ring

[73] 蒂廷國際有限公司
香港
九龍紅磡民裕街 41 號
凱旋工商中心一期一樓，A3 室

[74] 蒂廷國際有限公司
香港
九龍紅磡民裕街 41 號
凱旋工商中心一期一樓，A3 室



[11] 2423461.1

[15] 04-06-2024

[51] Cl. 11-01

[54] 戒指
Ring

[73] 蒂廷國際有限公司
香港
九龍紅磡民裕街 41 號
凱旋工商中心一期一樓，A3 室

- [74] 蒂廷國際有限公司
香港
九龍紅磡民裕街 41 號
凱旋工商中心一期一樓，A3 室

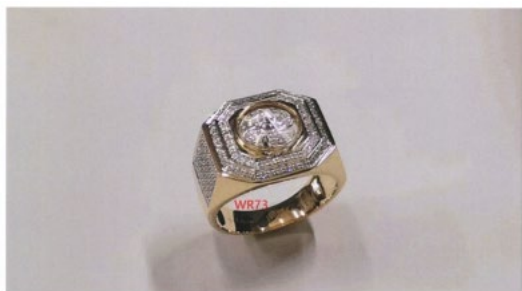

-
- [11] 2423462.3
[15] 04-06-2024
[51] Cl. 11-01
[54] 戒指
Ring
[73] 蒂廷國際有限公司
香港
九龍紅磡民裕街 41 號
凱旋工商中心一期一樓，A3 室
[74] 蒂廷國際有限公司
香港
九龍紅磡民裕街 41 號
凱旋工商中心一期一樓，A3 室



-
- [11] 2423463.5
[15] 04-06-2024
[51] Cl. 11-01
[54] 戒指
Ring

[73] 蒂廷國際有限公司
香港
九龍紅磡民裕街 41 號
凱旋工商中心一期一樓，A3 室

[74] 蒂廷國際有限公司
香港
九龍紅磡民裕街 41 號
凱旋工商中心一期一樓，A3 室



[11] 2423464.7

[15] 04-06-2024

[51] Cl. 11-01

[54] 戒指
Ring

[73] 蒂廷國際有限公司
香港
九龍紅磡民裕街 41 號
凱旋工商中心一期一樓，A3 室

[74] 蒂廷國際有限公司
香港
九龍紅磡民裕街 41 號
凱旋工商中心一期一樓，A3 室



[11] 2423465.0

[15] 04-06-2024

[51] Cl. 11-01

[54] 戒指
Ring

[73] 蒂廷國際有限公司
香港
九龍紅磡民裕街 41 號
凱旋工商中心一期一樓，A3 室

[74] 蒂廷國際有限公司
香港
九龍紅磡民裕街 41 號
凱旋工商中心一期一樓，A3 室



- [11] 2423467.4
[15] 04-06-2024
[30] 04-12-2023 / US / 29/919,420
[51] Cl. 13-02
[54] 充電盒
Charging case
[73] Bose Corporation
The Mountain,
Framingham, Massachusetts 01701-9168,
United States of America
[74] WENPING PATENT & TRADE MARK AGENT LIMITED
1701 Tung Wai Commercial Building,
111 Gloucester Road,
Hong Kong

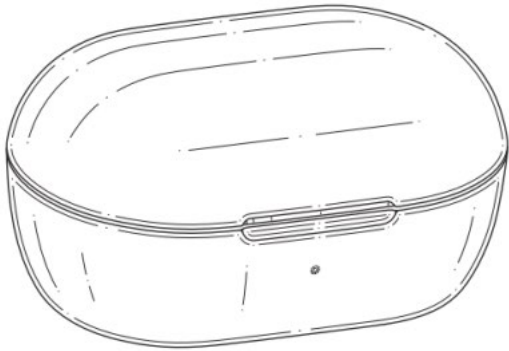

-
- [11] 2423468.6
[15] 04-06-2024
[30] 04-12-2023 / US / 29/919,429
[51] Cl. 14-01
[54] 耳塞式耳筒
Earbud
[73] Bose Corporation
The Mountain,
Framingham, Massachusetts 01701-9168,
United States of America
[74] WENPING PATENT & TRADE MARK AGENT LIMITED
1701 Tung Wai Commercial Building,
111 Gloucester Road,
Hong Kong



[11] 2423469.8

[15] 23-07-2024

[51] Cl. 9-03

[54] 包裝盒

Packing box

[73] 華人藥業(香港)有限公司

香港

觀塘開源道 60 號

駱駝漆大廈 3 座 7 樓 Q 室

[74] 華人藥業(香港)有限公司

香港

觀塘開源道 60 號

駱駝漆大廈 3 座 7 樓 Q 室



[11] 2423470.0

[15] 04-06-2024

[30] 04-12-2023 / US / 29/919,425

[51] Cl. 13-02

[54] 帶耳塞的充電盒

Charging case with earbuds

[73] Bose Corporation

The Mountain,

Framingham, Massachusetts 01701-9168,

United States of America

[74] WENPING PATENT & TRADE MARK AGENT LIMITED

1701 Tung Wai Commercial Building,

111 Gloucester Road,

Hong Kong

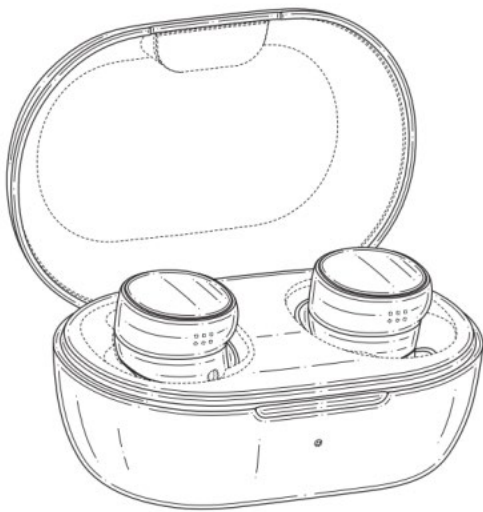

[11] 2423478.7

[15] 05-06-2024

[51] Cl. 13-02

[54] 折疊無線充電器

Folding wireless charger

[73] 深圳麦基克斯科技有限公司

中國

深圳市龙华区大浪街道

同胜社区快乐冷链厂1栋602

[74] 普潤知識產權(香港)有限公司

香港

銅鑼灣怡和街28號

恒生銅鑼灣大廈12樓B室

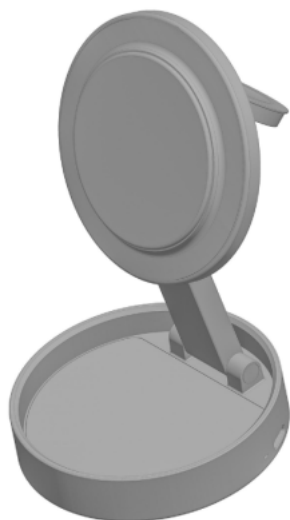

[11] 2423522.2M001

[15] 13-06-2024

[30] 14-12-2023 / DE / 402023100896.4

[51] Cl. 21-01

[54] 玩具或比例模型車

Toy or scale model vehicle

[73] Bayerische Motoren Werke Aktiengesellschaft

Petuelring 130, 80809 Muenchen,
Germany

[74] HASTINGS & CO

1101, 11th Floor, Gloucester Tower, The Landmark,
15 Queen's Road Central,
Hong Kong



[11] 2423522.2M002

[15] 13-06-2024

[30] 14-12-2023 / DE / 402023100896.4

[51] Cl. 21-01

[54] 玩具或比例模型車

Toy or scale model vehicle

[73] Bayerische Motoren Werke Aktiengesellschaft
Petuelring 130, 80809 Muenchen,
Germany

[74] HASTINGS & CO
1101, 11th Floor, Gloucester Tower, The Landmark,
15 Queen's Road Central,
Hong Kong



[11] 2423532.3

[15] 17-06-2024

[30] 22-01-2024 / AU / 202410360

[51] Cl. 6-06

[54] 床墊彈簧

Mattress wire coil

[73] Madad Pty Ltd

1299 Boundary Road, Wacol, QLD 4076,
Australia

[74] SPRUSON & FERGUSON (HONG KONG) LIMITED

5001 Hopewell Centre,
183 Queen's Road East, Wan Chai,
Hong Kong

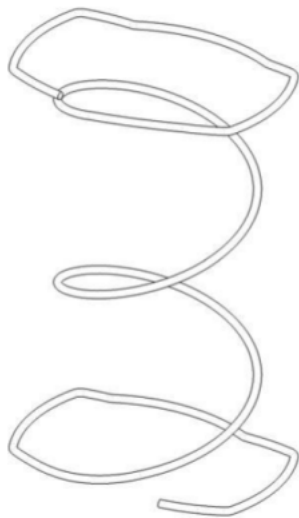

[11] 2423558.8

[15] 21-06-2024

[30] 19-04-2024 / JP / 2024-008143

[51] Cl. 23-01

[54] 淨水器

Water purifier

[73] 松下知識產權經營株式會社

Panasonic Intellectual Property Management Co., Ltd.

22-6, Moto-machi, Kadoma-shi, Osaka 571-0057,

Japan

[74] MARKS & CLERK

Level 9, Cyberport 1,

100 Cyberport Road, Pok Fu Lam,

Hong Kong

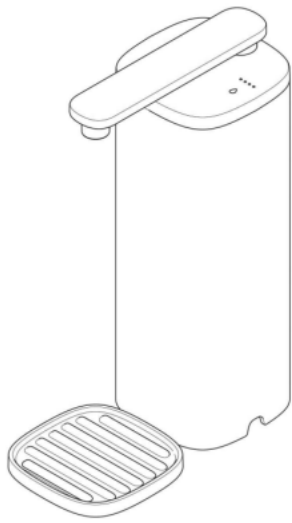

[11] 2423565.3

[15] 21-06-2024

[30] 21-12-2023 / KR / 30-2023-0052461

[51] Cl. 2-02

[54] 連帽衛衣

Hood T-shirt

[73] 株式會社可薄色門

COVER-SOMEONE CORPORATION

#B207, B208, B211,

51 Seongsui-ro, Seongdong-gu, Seoul,

Republic of Korea

[74] MARKS & CLERK

Level 9, Cyberport 1,

100 Cyberport Road, Pok Fu Lam,

Hong Kong



-
- [11] 2423566.5
[15] 21-06-2024
[30] 21-12-2023 / KR / 30-2023-0052462
[51] Cl. 2-02
[54] 連帽衛衣
Hood T-shirt
[73] 株式會社可薄色門
COVER-SOMEONE CORPORATION
#B207, B208, B211,
51 Seongsui-ro, Seongdong-gu, Seoul,
Republic of Korea
[74] MARKS & CLERK
Level 9, Cyberport 1,
100 Cyberport Road, Pok Fu Lam,
Hong Kong



-
- [11] 2423629.9
[15] 03-07-2024
[51] Cl. 21-01
[54] 人物玩具公仔
A character toy figure

[73] 周勳旻

CHOW HONG MAN

FLAT 1, BLK B, 19/F, GREENERY PLAZA,
CHUI YI ST, TAI PO, NEW TERRITORIES,
HONG KONG

[74] Chow Hong Man

FLAT 1, BLK B, 19/F, GREENERY PLAZA,
CHUI YI ST, TAI PO, NEW TERRITORIES,
HONG KONG

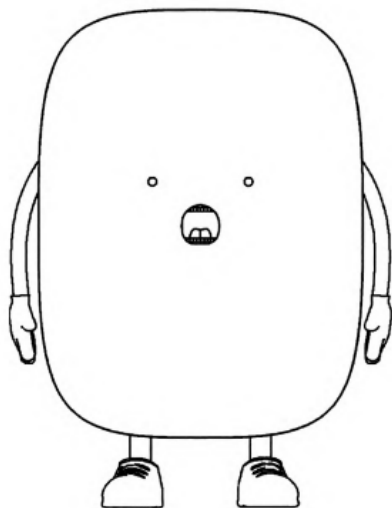

[11] 2423671.7

[15] 11-07-2024

[30] 12-01-2024 / IT / 402024000000078

[51] Cl. 23-06

[54] 淋浴頭

Shower head

[73] GESSI S.P.A.

PARCO GESSI,
FRAZIONE VINTEBBIO,
13037 SERRAVALLE SESIA (VC),
ITALY

[74] WENPING PATENT & TRADE MARK AGENT LIMITED

1701 Tung Wai Commercial Building,
111 Gloucester Road,
Hong Kong

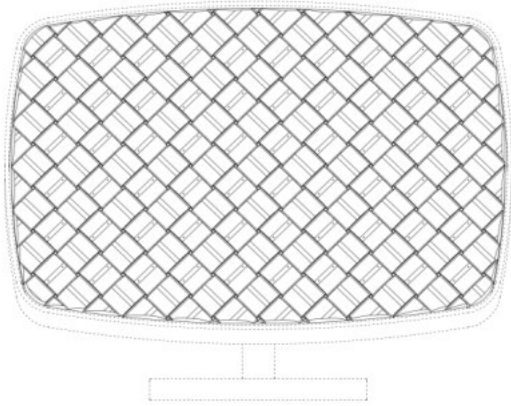

[11] 2423695.8M001

[15] 16-07-2024

[51] C1. 9-03

[54] 包裝盒

Packaging box

[73] 趙書玲

香港

葵涌打磚坪街 49-53 號

華基工業大廈第一期 20 樓 L 室

[74] 趙書玲

香港

葵涌打磚坪街 49-53 號

華基工業大廈第一期 20 樓 L 室



[11] 2423695.8M002

[15] 16-07-2024

[51] C1. 9-03

[54] 包裝盒

Packaging box

[73] 趙書玲
香港
葵涌打磚坪街 49-53 號
華基工業大廈第一期 20 樓 L 室

[74] 趙書玲
香港
葵涌打磚坪街 49-53 號
華基工業大廈第一期 20 樓 L 室

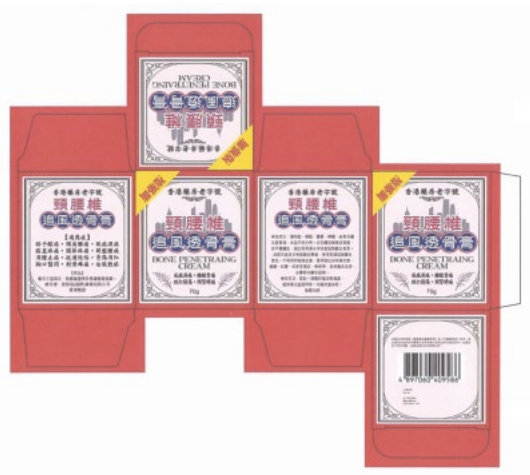

[11] 2423695.8M003

[15] 16-07-2024

[51] C1. 9-03

[54] 包裝盒
Packaging box

[73] 趙書玲
香港
葵涌打磚坪街 49-53 號
華基工業大廈第一期 20 樓 L 室

[74] 趙書玲
香港
葵涌打磚坪街 49-53 號
華基工業大廈第一期 20 樓 L 室



[11] 2423707.5M001

[15] 17-07-2024

[30] 27-02-2024 / EU / 015051866-0001

[51] Cl. 12-06

[54] 雙體船

Catamaran

[73] Sunreef Yachts RMC FZC

PO Box 5130, RAK Maritime City,

Ras Al Khaimah,

United Arab Emirates

[74] LEHMAN, LEE & XU PATENT AND TRADEMARK AGENTS LIMITED

Suite 3313, Tower One, Times Square,

1 Matheson Street, Causeway Bay,

Hong Kong

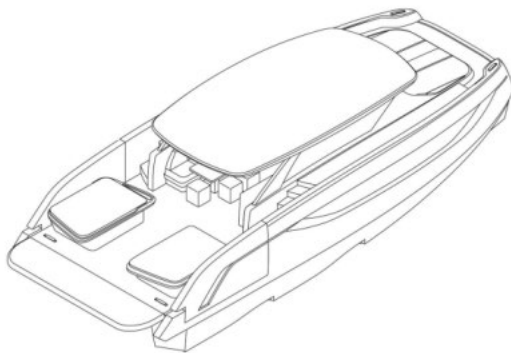

[11] 2423707.5M002

[15] 17-07-2024

[30] 27-02-2024 / EU / 015051866-0002

[51] Cl. 12-06

[54] 雙體船

Catamaran

[73] Sunreef Yachts RMC FZC

PO Box 5130, RAK Maritime City,

Ras Al Khaimah,

United Arab Emirates

[74] LEHMAN, LEE & XU PATENT AND TRADEMARK AGENTS LIMITED

Suite 3313, Tower One, Times Square,

1 Matheson Street, Causeway Bay,

Hong Kong

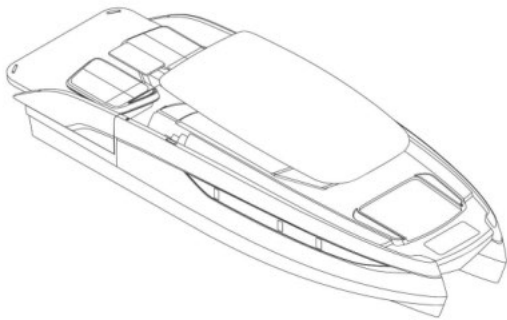

[11] 2423707.5M003

[15] 17-07-2024

[30] 27-02-2024 / EU / 015051866-0003

[51] Cl. 12-06

[54] 雙體船

Catamaran

[73] Sunreef Yachts RMC FZC

PO Box 5130, RAK Maritime City,

Ras Al Khaimah,

United Arab Emirates

[74] LEHMAN, LEE & XU PATENT AND TRADEMARK AGENTS LIMITED

Suite 3313, Tower One, Times Square,

1 Matheson Street, Causeway Bay,

Hong Kong

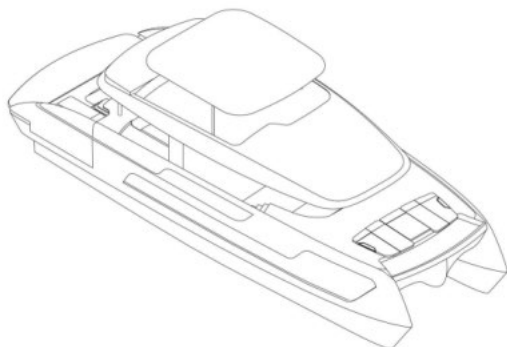

[11] 2423708.7

[15] 17-07-2024

[30] 05-02-2024 / JP / 2024-002400

[51] Cl. 23-04

[54] 空氣淨化器

Air cleaner

[73] 松下知識產權經營株式會社

Panasonic Intellectual Property Management Co., Ltd.

22-6, Moto-machi, Kadoma-shi, Osaka 571-0057,

Japan

[74] MARKS & CLERK

Level 9, Cyberport 1,

100 Cyberport Road, Pok Fu Lam,

Hong Kong

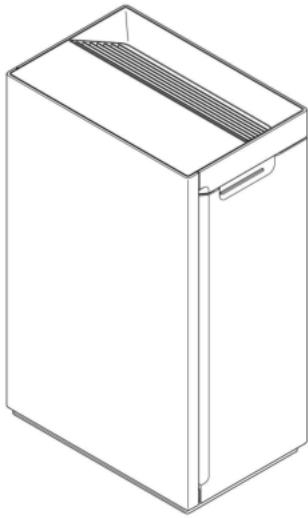

[11] 2423709.9

[15] 17-07-2024

[51] Cl. 16-06

[54] 眼鏡

Glasses

[73] ODD SKIN OUT LIMITED

UNIT 1104A, 11/F, KAI TAK COMM BLDG,

317-319 DES VOEUX ROAD, SHEUNG WAN,

HONG KONG

[74] LISHI INTELLECTUAL PROPERTY GROUP (INTERNATIONAL) LIMITED

Unit 9045, 9/F, Block B, Chung Mei Centre,

15-17 Hing Yip Street, Kwun Tong, Kowloon,

Hong Kong



[11] 2423715.2

[15] 18-07-2024

[30] 19-01-2024 / EU / 015047959-0001

[51] Cl. 7-02

[54] 平底深鍋
Saucepan

[73] CRISTEL
Parc d'Activité du Moulin,
25490 Fesches-le-Chatel,
France

[74] HONG KONG PATENT & TRADEMARK AGENT LIMITED
UNIT 10A, GRAND SCHOLAR BUILDING,
NO. 419K QUEEN'S ROAD WEST,
HONG KONG



[11] 2423716.4

[15] 18-07-2024

[30] 19-01-2024 / EU / 015047964-0001

[51] Cl. 7-02

[54] 平底深鍋
Saucepan

[73] CRISTEL
Parc d'Activité du Moulin,
25490 Fesches-le-Chatel,
France

[74] HONG KONG PATENT & TRADEMARK AGENT LIMITED
UNIT 10A, GRAND SCHOLAR BUILDING,
NO. 419K QUEEN'S ROAD WEST,
HONG KONG



[11] 2423717.6M001

[15] 18-07-2024

[30] 18-01-2024 / JP / 2024-000790

[51] Cl. 9-01

[54] 化妝品用瓶
Bottle for cosmetics

[73] Shiseido Company, Limited
5-5, Ginza 7-chome, Chuo-ku,
Tokyo 104-0061,
Japan

[74] MARKS & CLERK
Level 9, Cyberport 1,
100 Cyberport Road, Pok Fu Lam,
Hong Kong

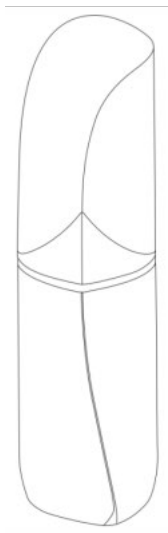

[11] 2423717.6M002

[15] 18-07-2024

[30] 18-01-2024 / JP / 2024-000791

[51] Cl. 9-01

[54] 化妝品用瓶

Bottle for cosmetics

[73] Shiseido Company, Limited

5-5, Ginza 7-chome, Chuo-ku,

Tokyo 104-0061,

Japan

[74] MARKS & CLERK

Level 9, Cyberport 1,

100 Cyberport Road, Pok Fu Lam,

Hong Kong

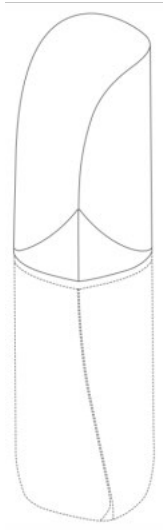

[11] 2423723.8M001

[15] 18-07-2024

[51] Cl. 21-01

[54] 玩具農舍

Toy farm house

[73] 集美塑膠玩具製品廠有限公司

Chap Mei Plastic Toys Manufactory Limited
Unit 541, 5/F., Sino Industrial Plaza,
9 Kai Cheung Road, Kowloon Bay, Kowloon,
Hong Kong

[74] BENNY KONG & TSAI

Unit 19B, Overseas Trust Bank Building,
No. 160 Gloucester Road, Wanchai,
Hong Kong



[11] 2423723.8M002

[15] 18-07-2024

[51] Cl. 21-01

[54] 玩具農用拖拉機

Toy farm tractor

[73] 集美塑膠玩具製品廠有限公司

Chap Mei Plastic Toys Manufactory Limited
Unit 541, 5/F., Sino Industrial Plaza,
9 Kai Cheung Road, Kowloon Bay, Kowloon,
Hong Kong

[74] BENNY KONG & TSAI

Unit 19B, Overseas Trust Bank Building,
No. 160 Gloucester Road, Wanchai,
Hong Kong



[11] 2423723.8M003

[15] 18-07-2024

[51] Cl. 21-01

[54] 玩具農夫

Toy farmer

[73] 集美塑膠玩具製品廠有限公司

Chap Mei Plastic Toys Manufactory Limited

Unit 541, 5/F., Sino Industrial Plaza,
9 Kai Cheung Road, Kowloon Bay, Kowloon,
Hong Kong

[74] BENNY KONG & TSAI

Unit 19B, Overseas Trust Bank Building,
No. 160 Gloucester Road, Wanchai,
Hong Kong



[11] 2423723.8M004

[15] 18-07-2024

[51] Cl. 21-01

[54] 玩具女農夫

Toy female farmer

- [73] 集美塑膠玩具製品廠有限公司
Chap Mei Plastic Toys Manufactory Limited
Unit 541, 5/F., Sino Industrial Plaza,
9 Kai Cheung Road, Kowloon Bay, Kowloon,
Hong Kong
- [74] BENNY KONG & TSAI
Unit 19B, Overseas Trust Bank Building,
No. 160 Gloucester Road, Wanchai,
Hong Kong



-
- [11] 2423729.1
- [15] 19-07-2024
- [51] C1. 25-03
- [54] 風力發電機組塔架組
Tower set of wind driven generator set
- [73] 香港格林技術有限公司
HONG KONG GREEN TECHNOLOGICAL CO., LIMITED
香港
灣仔軒尼詩道 253-261 號
依時商業大廈 1801 室
- [74] 萬慧達 (亞太) 諮詢有限公司
香港
灣仔港灣道 18 號
中環廣場 1903 室



[11] 2423730.3M001

[15] 19-07-2024

[30] 31-01-2024 / BG, DK, BE, FI, FR, DE, GR, LU, MC, NL, NO, CN,
HU, RO, SG, ES, CH, VN, IL, IT, KR / DM/235159

[51] Cl. 9-01

[54] 瓶

Bottle

[73] CHANEL

135 avenue Charles de Gaulle,
92200 Neuilly-sur-Seine,
France

[74] WILKINSON & GRIST

6th Floor, Prince's Building,
Chater Road,
Hong Kong

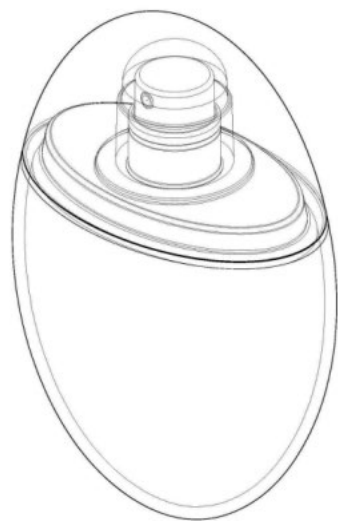

[11] 2423730.3M002

[15] 19-07-2024

[30] 31-01-2024 / BG, DK, BE, FI, FR, DE, GR, LU, MC, NL, NO, CN,
HU, RO, SG, ES, CH, VN, IL, IT, KR / DM/235159

[51] Cl. 9-01

[54] 瓶

Bottle

[73] CHANEL

135 avenue Charles de Gaulle,
92200 Neuilly-sur-Seine,
France

[74] WILKINSON & GRIST

6th Floor, Prince's Building,
Chater Road,
Hong Kong



[11] 2423731.5M001

[15] 19-07-2024

[30] 09-02-2024 / BG, HR, DK, BE, FI, FR, DE, GR, LU, MC, NL, NO,
CN, HU, RO, SK, ES, CH, IT, KR / DM/235194

[51] Cl. 28-03

[54] 眼部修護乳霜施用器

Eye serum applicator

[73] CHANEL

135 avenue Charles de Gaulle,
92200 Neuilly-sur-Seine,
France

[74] WILKINSON & GRIST

6th Floor, Prince's Building,

Chater Road,
Hong Kong

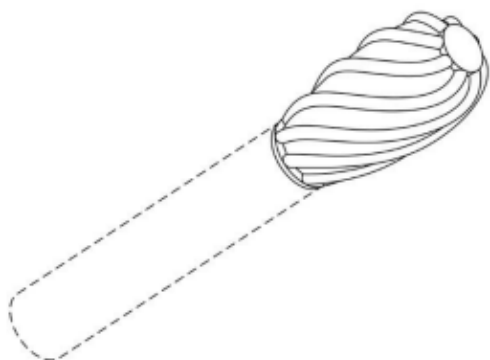

[11] 2423731.5M002

[15] 19-07-2024

[30] 09-02-2024 / BG, HR, DK, BE, FI, FR, DE, GR, LU, MC, NL, NO,
CN, HU, RO, SK, ES, CH, IT, KR / DM/235194

[51] Cl. 28-03

[54] 眼部修護乳霜施用器
Eye serum applicator

[73] CHANEL
135 avenue Charles de Gaulle,
92200 Neuilly-sur-Seine,
France

[74] WILKINSON & GRIST
6th Floor, Prince's Building,
Chater Road,
Hong Kong

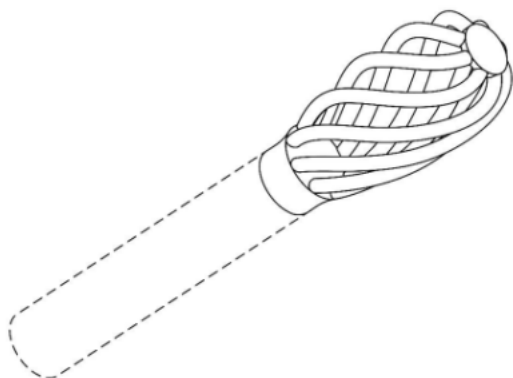

[11] 2423734.1

[15] 20-07-2024

[51] Cl. 26-02

[54] 燈籠
Lantern

[73] 蔡國浩
CHOI Kwok Ho
香港
元朗
朗屏邨寶屏樓 2809 號

[74] 蔡國浩
香港
新界 元朗 朗屏邨
寶屏樓 2809 室



[11] 2423737.8

[15] 22-07-2024

[51] Cl. 16-06

[54] 眼鏡
Glasses

[73] ODD SKIN OUT LIMITED
UNIT 1104A, 11/F, KAI TAK COMM BLDG,
317-319 DES VOEUX ROAD, SHEUNG WAN,
HONG KONG

[74] LISHI INTELLECTUAL PROPERTY GROUP (INTERNATIONAL) LIMITED
Unit 9045, 9/F, Block B, Chung Mei Centre,
15-17 Hing Yip Street, Kwun Tong, Kowloon,
Hong Kong



[11] 2423743.0

[15] 23-07-2024

[51] Cl. 25-01

[54] 地板

Decking

[73] Liu Sai Man

Room 2620, Tin Mei Hse, Tin Ping Est,
Sheung Shui, New Territories,
Hong Kong

[74] ACCOLADE IP LIMITED

10/F, Fu Fai Comm. Ctr.,
27 Hillier Street, Sheung Wan,
Hong Kong

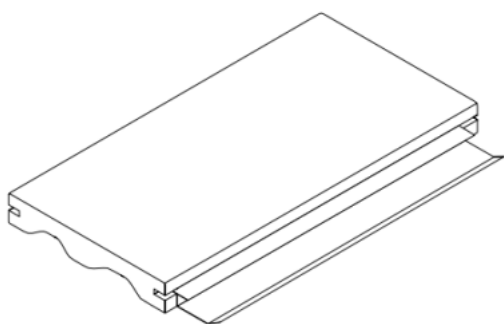

[11] 2423744.2

[15] 23-07-2024

[51] Cl. 6-09

[54] 珊瑚枕

Coral pillow

[73] 泰森集團有限公司
英屬處女群島
托托拉島羅德城弗朗西斯·德瑞克先生公路 3076 號
埃倫·斯凱爾頓大廈 4 樓保得利辦事處

[74] 泰森集團有限公司
香港
香港灣仔皇后大道東 213 號
胡忠大廈 28 樓 2810 室



[11] 2423750.5

[15] 24-07-2024

[51] Cl. 14-03

[54] 數碼天線
Digital antenna

[73] 旺角電子(香港)有限公司
Mongkok Electronics (Hong Kong) Ltd
香港
旺角黑布街 100 号地下

[74] 旺角電子(香港)有限公司
香港
旺角黑布街 100 号地下

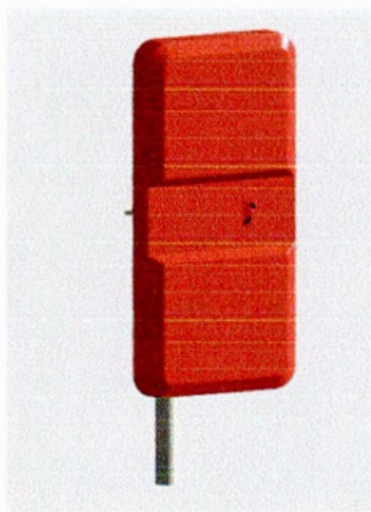

- [11] 2423751.7
- [15] 24-07-2024
- [30] 20-03-2024 / EU / 015054352-0001
- [51] Cl. 14-02
- [54] 資訊處理裝置
Information processing device
- [73] LEDGER
1 Rue du Mail,
75002 Paris,
France
- [74] WILKINSON & GRIST
6th Floor, Prince's Building,
Chater Road, Central,
Hong Kong

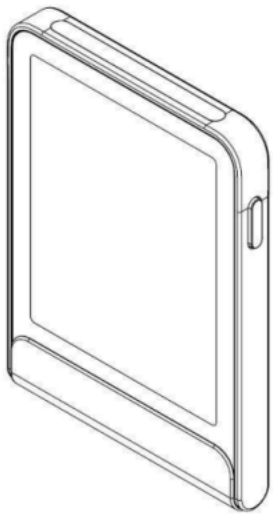

-
- [11] 2423752.9
 - [15] 24-07-2024
 - [30] 08-03-2024 / CA, AZ, MX, MC, ME, MA, NO, RU, SG, CH, TR, UA,
GB, US, EU, JP, KR / WIPO145546
 - [51] Cl. 2-04
 - [54] 鞋
Footwear
 - [73] CHRISTIAN DIOR COUTURE
30 Avenue Montaigne,
75008 Paris,
France
 - [74] WILKINSON & GRIST
6th Floor, Prince's Building,
Chater Road, Central,
Hong Kong



-
- [11] 2423755.6
 - [15] 25-07-2024
 - [30] 19-02-2024 / JP / 2024-003340
 - [51] Cl. 9-03
 - [54] 包裝用箱
Packing box
 - [73] 久光製藥株式會社
HISAMITSU PHARMACEUTICAL CO., INC.
408, Tashirodaikan-machi,
Tosu-shi, Saga 841-0017,
JAPAN
 - [74] WILKINSON & GRIST
6th Floor, Prince's Building,
Chater Road, Central,
Hong Kong



-
- [11] 2423756.8

[15] 25-07-2024

[51] Cl. 3-01

[54] 迷你托特包

Mini belted tote bag

[73] 東莞市利得製造有限公司

Nefertiti Manufacturing (Dongguan) Ltd.

中國

廣東省東莞市常平鎮土塘港建路 27 號 2 棟 3 樓

[74] 袁丹吉

香港

中環康樂廣場 1 號

怡和大廈 2206-19 室



[11] 2423787.3M001

[15] 30-07-2024

[30] 01-02-2024 / EU / 015049306-0001

[51] Cl. 7-05

[54] 蒸汽掛燙機

Garment steamer

[73] VERSUNI HOLDING B.V.

HIGH TECH CAMPUS 42, 5656AE EINDHOVEN,

NETHERLANDS

[74] CHANG TSI AND PARTNERS INTELLECTUAL PROPERTY (HK) LIMITED

Level 20, One International Finance Centre,

No. 1 Harbour View Street, Central,

Hong Kong



[11] 2423787.3M002

[15] 30-07-2024

[30] 01-02-2024 / EU / 015049306-0002

[51] Cl. 7-05

[54] 蒸汽掛燙機

Garment steamer

[73] VERSUNI HOLDING B.V.

HIGH TECH CAMPUS 42, 5656AE EINDHOVEN,
NETHERLANDS

[74] CHANG TSI AND PARTNERS INTELLECTUAL PROPERTY (HK) LIMITED

Level 20, One International Finance Centre,
No. 1 Harbour View Street, Central,
Hong Kong

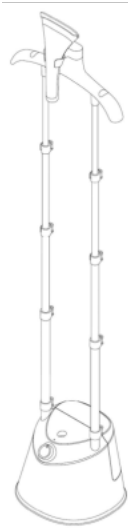

[11] 2423787.3M003

[15] 30-07-2024

[30] 01-02-2024 / EU / 015049306-0003

[51] Cl. 7-05

[54] 蒸汽掛燙機

Garment steamer

[73] VERSUNI HOLDING B.V.

HIGH TECH CAMPUS 42, 5656AE EINDHOVEN,
NETHERLANDS

[74] CHANG TSI AND PARTNERS INTELLECTUAL PROPERTY (HK) LIMITED

Level 20, One International Finance Centre,
No. 1 Harbour View Street, Central,
Hong Kong

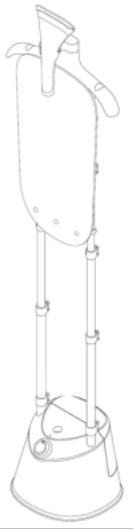

[11] 2423787.3M004

[15] 30-07-2024

[30] 01-02-2024 / EU / 015049306-0004

[51] Cl. 7-05

[54] 蒸汽掛燙機

Garment steamer

[73] VERSUNI HOLDING B.V.

HIGH TECH CAMPUS 42, 5656AE EINDHOVEN,
NETHERLANDS

[74] CHANG TSI AND PARTNERS INTELLECTUAL PROPERTY (HK) LIMITED

Level 20, One International Finance Centre,
No. 1 Harbour View Street, Central,
Hong Kong

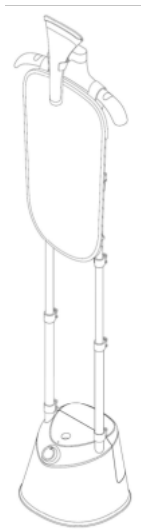

[11] 2423787.3M005

[15] 30-07-2024

[30] 01-02-2024 / EU / 015049306-0005

[51] Cl. 7-05

[54] 蒸汽掛燙機

Garment steamer

[73] VERSUNI HOLDING B.V.

HIGH TECH CAMPUS 42, 5656AE EINDHOVEN,
NETHERLANDS

[74] CHANG TSI AND PARTNERS INTELLECTUAL PROPERTY (HK) LIMITED

Level 20, One International Finance Centre,
No. 1 Harbour View Street, Central,
Hong Kong

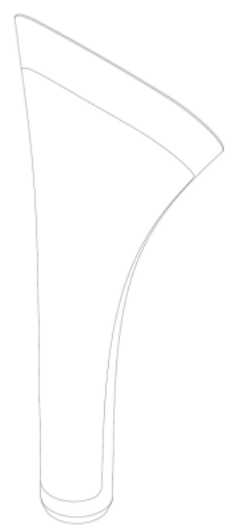

[11] 2423787.3M006

[15] 30-07-2024

[30] 01-02-2024 / EU / 015049306-0006

[51] Cl. 7-05

[54] 蒸汽掛燙機

Garment steamer

[73] VERSUNI HOLDING B.V.

HIGH TECH CAMPUS 42, 5656AE EINDHOVEN,
NETHERLANDS

[74] CHANG TSI AND PARTNERS INTELLECTUAL PROPERTY (HK) LIMITED

Level 20, One International Finance Centre,
No. 1 Harbour View Street, Central,
Hong Kong

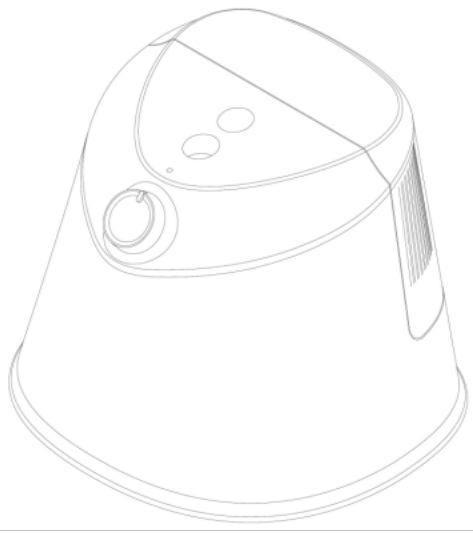

[11] 2423787.3M007

[15] 30-07-2024

[30] 01-02-2024 / EU / 015049306-0007

[51] Cl. 7-05

[54] 蒸汽掛燙機

Garment steamer

[73] VERSUNI HOLDING B.V.

HIGH TECH CAMPUS 42, 5656AE EINDHOVEN,
NETHERLANDS

[74] CHANG TSI AND PARTNERS INTELLECTUAL PROPERTY (HK) LIMITED

Level 20, One International Finance Centre,
No. 1 Harbour View Street, Central,
Hong Kong

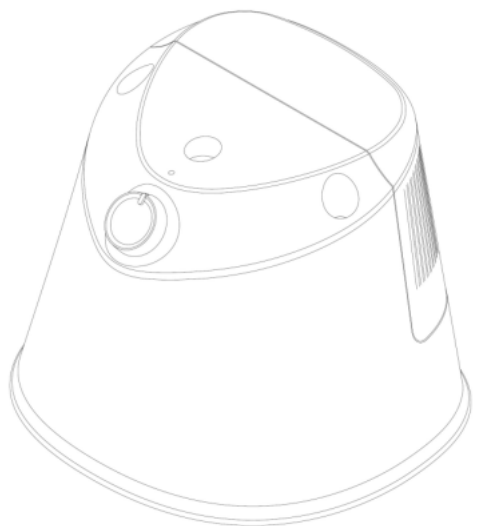

[11] 2423787.3M008

[15] 30-07-2024

[30] 01-02-2024 / EU / 015049306-0008

[51] Cl. 7-05

[54] 蒸汽掛燙機

Garment steamer

[73] VERSUNI HOLDING B.V.

HIGH TECH CAMPUS 42, 5656AE EINDHOVEN,
NETHERLANDS

[74] CHANG TSI AND PARTNERS INTELLECTUAL PROPERTY (HK) LIMITED

Level 20, One International Finance Centre,
No. 1 Harbour View Street, Central,
Hong Kong



[11] 2423787.3M009

[15] 30-07-2024

[30] 01-02-2024 / EU / 015049306-0009

[51] Cl. 7-05

[54] 蒸汽掛燙機

Garment steamer

[73] VERSUNI HOLDING B.V.

HIGH TECH CAMPUS 42, 5656AE EINDHOVEN,
NETHERLANDS

[74] CHANG TSI AND PARTNERS INTELLECTUAL PROPERTY (HK) LIMITED

Level 20, One International Finance Centre,
No. 1 Harbour View Street, Central,
Hong Kong



[11] 2423796.2

[15] 01-08-2024

[51] Cl. 21-01

[54] 驚喜獨角獸扭蛋玩具

Surprise unicorn capsule toy

[73] PREMIUM TOYS LIMITED

UNIT 345-346, 3/F., PENINSULA CENTRE,
67 MODY ROAD, TSIM SHA TSUI (EAST), KOWLOON,
HONG KONG

[74] PREMIUM TOYS LIMITED

UNIT 345-346, 3/F., PENINSULA CENTRE,
67 MODY ROAD, TSIM SHA TSUI (EAST), KOWLOON,
HONG KONG



[11] 2423797.4

[15] 01-08-2024

[51] C1. 21-01

[54] 迷你獨角獸扭蛋玩具

Mini unicorn capsule toy

[73] PREMIUM TOYS LIMITED

UNIT 345-346, 3/F., PENINSULA CENTRE,
67 MODY ROAD, TSIM SHA TSUI (EAST), KOWLOON,
HONG KONG

[74] PREMIUM TOYS LIMITED

UNIT 345-346, 3/F., PENINSULA CENTRE,
67 MODY ROAD, TSIM SHA TSUI (EAST), KOWLOON,
HONG KONG





香港特別行政區政府知識產權署外觀設計註冊處

The Government of the Hong Kong Special Administrative Region

Designs Registry, Intellectual Property Department

根據註冊外觀設計條例第 28 條，下列註冊外觀設計因未繳續期費而停止有效。

各組記項按註冊外觀設計停止有效日期及註冊編號先後次序排列。

Registered designs ceased through non-payment of renewal fees under section 28 of the Registered Designs Ordinance. Entries are listed below under their expiry dates.

15-08-2024 - 20-08-2024

15-08-2024

0411810.5	1401551.5
1914470.2M001	1914481.5
1914470.2M002	1914484.1M001
1914470.2M003	1914484.1M002
1914470.2M004	1914484.1M003
1914473.8	1914484.1M004
1914474.0	1914484.1M005
	1914485.4
	1914486.6

17-08-2024

1401527.5M003	1914487.8
1401527.5M004	1914488.0
1401527.5M006	1914489.2
1401528.7	1914490.4
	1914491.6
	1914492.8

18-08-2024

0411824.4	1914493.0
0411826.9M002	1914498.1
0411826.9M003	1914499.3
0411826.9M004	1914500.8
1401544.0	1914501.0
1914476.5	1914502.2
	1914503.4
	1914504.6

19-08-2024

0411832.1M005
0411833.3M005
0411842.2M001
0411842.2M002
0901344.8
0901345.1
1401545.3
1401546.5M004
1401546.5M006
1401550.3M002

20-08-2024

1401567.9M003
1401567.9M004
1401567.9M005
1914505.9



香港特別行政區政府知識產權署外觀設計註冊處

The Government of the Hong Kong Special Administrative Region

Designs Registry, Intellectual Property Department

根據註冊外觀設計規則第 31 條刪除的註冊外觀設計。各組記項按註冊外觀設計刪除日期及註冊編號先後次序排列。

Registered designs removed under section 31 of the Registered Designs Rules. Entries are listed below under their removal dates.

23-08-2024 - 28-08-2024**23-08-2024**0900239.5
0900240.7
0900241.9M001
0900241.9M002
0900241.9M004
0900241.9M005**25-08-2024**0900259.7
1400279.6M001
1400279.6M002
1400280.8M001
1400280.8M002
1400280.8M003
1400280.8M004
1400280.8M005
1400280.8M006
1400280.8M007
1913046.3**26-08-2024**0410329.3
0410331.7
0410336.8
0900268.6
0900269.8
1400285.9
1913053.7M001
1913053.7M002
1913053.7M003
1913053.7M004
1913053.7M005
1913053.7M006**27-08-2024**0900276.3
1400295.0
1400304.0
1913055.2
1913059.0
1913060.21913061.4
1913062.6M001
1913062.6M002
1913062.6M003
1913062.6M004
1913062.6M005
1913062.6M006
1913062.6M007**28-08-2024**1913064.0
1913065.3M001
1913065.3M002
1913066.5
1913069.1
1913071.5M002
1913072.7M002
1913072.7M003
1913072.7M004
1913072.7M005
1913073.9
1913074.1



香港特別行政區政府知識產權署外觀設計註冊處

The Government of the Hong Kong Special Administrative Region

Designs Registry, Intellectual Property Department

勘誤

CORRIGENDUM

已在官方公報刊登的外觀設計公告內的聲稱具有優先權更正如下:

The following show the corrected priority claim in advertisement previously published in the official journal:

官方公報日期 Official journal date 06.09.2024

[11] 2423033.4

[30] 27-09-2024/CN/2023306344987

27-09-2024/CN/2023306345693