

# 香港知識產權公報

Hong Kong Intellectual Property Journal

2025年2月14日  
14 February 2025

## 目錄 Contents

### 根據註冊外觀設計條例第 25 條註冊的外觀設計

#### **Designs Registered under section 25 of the Registered Designs Ordinance**

按註冊編號排列

Arranged by Registration Number

### 根據註冊外觀設計條例(第 522 章)公布的其他公告

#### **Other Notices Published under the Registered Designs Ordinance (Cap. 522)**

根據註冊外觀設計條例第 28 條，註冊外觀設計因未繳續期費而停止有效

Registered designs ceased through non-payment of renewal fees under section 28 of the Registered Designs Ordinance

根據註冊外觀設計規則第 31 條刪除的註冊外觀設計

Registered designs removed under section 31 of the Registered Designs Rules

根據註冊外觀設計條例第 76 條，更正已提交文件中的錯誤

Correction of errors in filed documents under section 76 of the Registered Designs Ordinance

### 以下事項沒有記錄

#### **No Records for the Following Matters**

根據註冊外觀設計條例第 30 條放棄的外觀設計的註冊

Surrender of Registration of Design under section 30 of the Registered Designs Ordinance

根據註冊外觀設計規則第 37 條，向處長作出轉介

Reference to Registrar under section 37 of the Registered Designs Rules

根據註冊外觀設計條例第 45 條，撤銷註冊

Revocation of Registration under section 45 of the Registered Designs Ordinance

根據註冊外觀設計規則第 46 條，向法院作出轉介

Reference to Court under section 46 of the Registered Designs Rules

根據註冊外觀設計規則第 63 條對不符合規定之處作出糾正

Rectification of Irregularities under section 63 of the Registered Designs Rules

根據註冊外觀設計條例第 66 條，糾正註冊紀錄冊

Rectification of Register under section 66 of the Registered Designs Ordinance

根據註冊外觀設計條例第 67 條 更正註冊紀錄冊內的錯誤

Correction of errors in Register under section 67 of the Registered Designs Ordinance

根據註冊外觀設計條例第 67 及 76 條，更正註冊紀錄冊內及已提交文件中的錯誤

Correction of Errors in Register and in Filed Documents under sections 67 and 76 of the Registered Designs Ordinance

勘誤

Corrigendum

## 註冊外觀設計公告註釋

### Notes on advertisements of registration of designs

方括號表示下列資料：

Square brackets indicate the following data：

[11] 註冊編號 Registration number / 聯合王國註冊編號 United Kingdom registration number

[15] 註冊日期 Registration date / 當作註冊日期 Deemed registration date / 聯合王國註冊日期 United Kingdom registration date

[17] 註冊有效期屆滿日期 Expiry date of the period of registration

[22] 提交日期 Filing date / 當作提交日期 Deemed filing date / 聯合王國提交日期 United Kingdom filing date

[30] 聲稱享有的優先權（提交日期 / 巴黎公約國或世界貿易組織成員 / 申請編號） Priority claimed (filing date / Paris Convention country or WTO member / application number)

[51] 國際外觀設計分類號（洛迦諾分類號） International Classification of designs (Locarno Classification)

[54] 物品 Article

[55] 外觀設計的表述 Representation of the design

[62] 分開前的申請編號及提交日期 Application number before division and filing date

[66] 過往註冊的聯繫外觀設計註冊編號 / 日期 Registration No. / Date of Previous Registration for Association

[72] 設計人 Designer

[73] 擁有人姓名和地址 Name and address of the owner

[74] 代理人 Agent /送達地址 Address for service



香港特別行政區政府知識產權署外觀設計註冊處  
The Government of the Hong Kong Special Administrative Region  
Designs Registry, Intellectual Property Department

## 根據註冊外觀設計條例第 25 條註冊的外觀設計

### Designs registered under section 25 of the Registered Designs Ordinance

按註冊編號排列

Arranged by Registration Number

[11] 2321918.9M001

[15] 12-11-2022

[30] 27-10-2022 / US / 29/867,534

27-10-2022 / US / 29/867,501

13-05-2022 / US / 29/838,534

[51] Cl. 19-08

[54] 藥物輸送裝置包裝標籤

Label for packaging medication delivery device

[73] ELI LILLY AND COMPANY

P.O. Box 6288,

Indianapolis, IN 46206-6288,

United States of America

[74] MARKS & CLERK

Level 9, Cyberport 1,

100 Cyberport Road,

Pok Fu Lam, Hong Kong



[11] 2321918.9M002

- [15] 12-11-2022
- [30] 27-10-2022 / US / 29/867,534  
27-10-2022 / US / 29/867,501  
13-05-2022 / US / 29/838,534
- [51] Cl. 19-08
- [54] 藥物輸送裝置包裝標籤  
Label for packaging medication delivery device
- [73] ELI LILLY AND COMPANY  
P.O. Box 6288,  
Indianapolis, IN 46206-6288,  
United States of America
- [74] MARKS & CLERK  
Level 9, Cyberport 1,  
100 Cyberport Road,  
Pok Fu Lam, Hong Kong

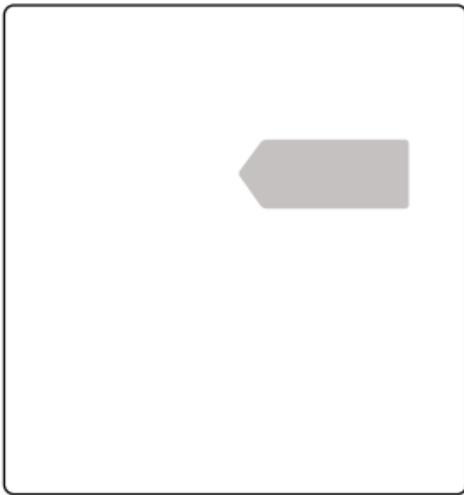

- 
- [11] 2321918.9M003
  - [15] 12-11-2022
  - [30] 27-10-2022 / US / 29/867,534  
27-10-2022 / US / 29/867,501  
13-05-2022 / US / 29/838,534
  - [51] Cl. 19-08
  - [54] 藥物輸送裝置包裝標籤  
Label for packaging medication delivery device
  - [73] ELI LILLY AND COMPANY  
P.O. Box 6288,  
Indianapolis, IN 46206-6288,  
United States of America
  - [74] MARKS & CLERK  
Level 9, Cyberport 1,

100 Cyberport Road,  
Pok Fu Lam, Hong Kong

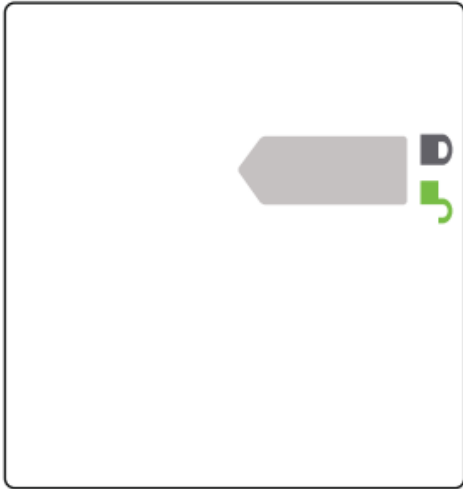

[11] 2321918.9M004

[15] 12-11-2022

[30] 27-10-2022 / US / 29/867,534

27-10-2022 / US / 29/867,501

13-05-2022 / US / 29/838,534

[51] Cl. 19-08

[54] 藥物輸送裝置包裝標籤

Label for packaging medication delivery device

[73] ELI LILLY AND COMPANY

P.O. Box 6288,

Indianapolis, IN 46206-6288,

United States of America

[74] MARKS & CLERK

Level 9, Cyberport 1,

100 Cyberport Road,

Pok Fu Lam, Hong Kong

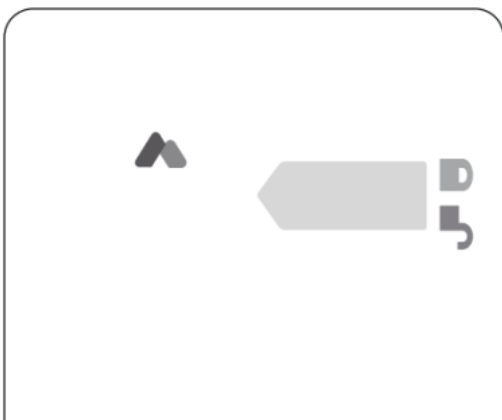



- [11] 2321918.9M005  
[15] 12-11-2022  
[30] 27-10-2022 / US / 29/867,534  
27-10-2022 / US / 29/867,501  
13-05-2022 / US / 29/838,534  
[51] Cl. 19-08  
[54] 藥物輸送裝置包裝標籤  
Label for packaging medication delivery device  
[73] ELI LILLY AND COMPANY  
P.O. Box 6288,  
Indianapolis, IN 46206-6288,  
United States of America  
[74] MARKS & CLERK  
Level 9, Cyberport 1,  
100 Cyberport Road,  
Pok Fu Lam, Hong Kong

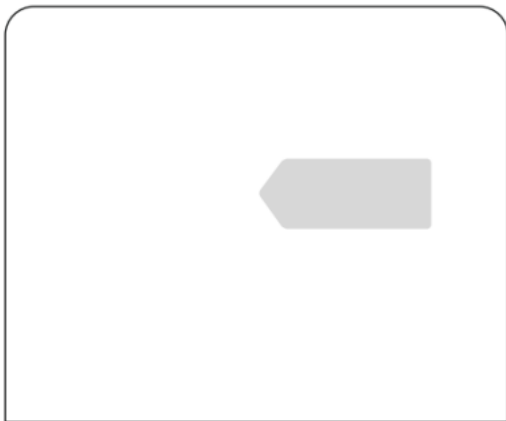

- 
- [11] 2321918.9M006  
[15] 12-11-2022  
[30] 27-10-2022 / US / 29/867,534  
27-10-2022 / US / 29/867,501  
13-05-2022 / US / 29/838,534  
[51] Cl. 19-08  
[54] 藥物輸送裝置包裝標籤  
Label for packaging medication delivery device  
[73] ELI LILLY AND COMPANY  
P.O. Box 6288,  
Indianapolis, IN 46206-6288,  
United States of America  
[74] MARKS & CLERK  
Level 9, Cyberport 1,

100 Cyberport Road,  
Pok Fu Lam, Hong Kong

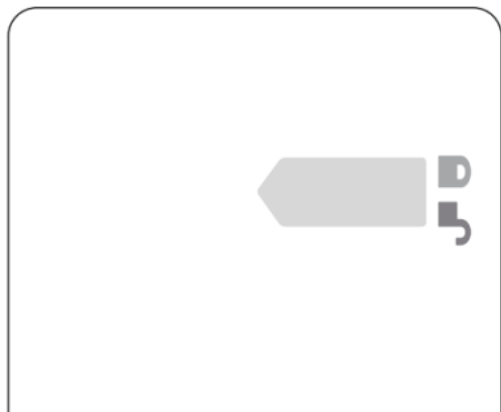

- 
- [11] 2321918.9M007
  - [15] 12-11-2022
  - [30] 27-10-2022 / US / 29/867,534  
27-10-2022 / US / 29/867,501  
13-05-2022 / US / 29/838,534
  - [51] Cl. 19-08
  - [54] 藥物輸送裝置包裝標籤  
Label for packaging medication delivery device
  - [73] ELI LILLY AND COMPANY  
P.O. Box 6288,  
Indianapolis, IN 46206-6288,  
United States of America
  - [74] MARKS & CLERK  
Level 9, Cyberport 1,  
100 Cyberport Road,  
Pok Fu Lam, Hong Kong



- 
- [11] 2321919.1M001

- [15] 12-11-2022
- [30] 27-10-2022 / US / 29/867,534  
13-05-2022 / US / 29/838,534  
27-10-2022 / US / 29/867,501
- [51] Cl. 24-02
- [54] 藥物輸送裝置  
Medication delivery device
- [73] ELI LILLY AND COMPANY  
P.O. Box 6288,  
Indianapolis, IN 46206-6288,  
United States of America
- [74] MARKS & CLERK  
Level 9, Cyberport 1,  
100 Cyberport Road,  
Pok Fu Lam, Hong Kong



- 
- [11] 2321919.1M002
  - [15] 12-11-2022
  - [30] 27-10-2022 / US / 29/867,534  
13-05-2022 / US / 29/838,534  
27-10-2022 / US / 29/867,501
  - [51] Cl. 24-02
  - [54] 藥物輸送裝置  
Medication delivery device
  - [73] ELI LILLY AND COMPANY  
P.O. Box 6288,  
Indianapolis, IN 46206-6288,  
United States of America
  - [74] MARKS & CLERK  
Level 9, Cyberport 1,

100 Cyberport Road,  
Pok Fu Lam, Hong Kong

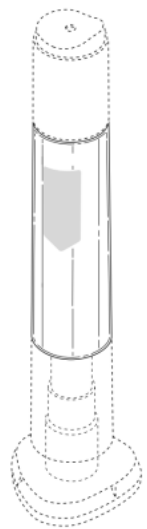

[11] 2321919.1M003

[15] 12-11-2022

[30] 27-10-2022 / US / 29/867,534

13-05-2022 / US / 29/838,534

27-10-2022 / US / 29/867,501

[51] Cl. 24-02

[54] 藥物輸送裝置

Medication delivery device

[73] ELI LILLY AND COMPANY

P.O. Box 6288,

Indianapolis, IN 46206-6288,

United States of America

[74] MARKS & CLERK

Level 9, Cyberport 1,

100 Cyberport Road,

Pok Fu Lam, Hong Kong

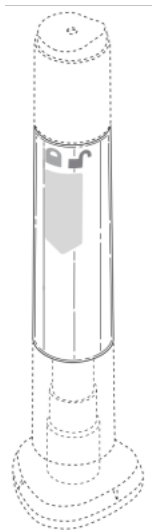

[11] 2321919.1M004

[15] 12-11-2022

[30] 27-10-2022 / US / 29/867,534

13-05-2022 / US / 29/838,534

27-10-2022 / US / 29/867,501

[51] Cl. 24-02

[54] 藥物輸送裝置

Medication delivery device

[73] ELI LILLY AND COMPANY

P.O. Box 6288,

Indianapolis, IN 46206-6288,

United States of America

[74] MARKS & CLERK

Level 9, Cyberport 1,

100 Cyberport Road,

Pok Fu Lam, Hong Kong

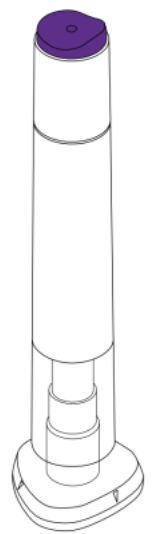

[11] 2321919.1M005

[15] 12-11-2022

[30] 27-10-2022 / US / 29/867,534

13-05-2022 / US / 29/838,534

27-10-2022 / US / 29/867,501

[51] Cl. 24-02

[54] 藥物輸送裝置

Medication delivery device

[73] ELI LILLY AND COMPANY

P.O. Box 6288,

Indianapolis, IN 46206-6288,

United States of America

[74] MARKS & CLERK

Level 9, Cyberport 1,

100 Cyberport Road,

Pok Fu Lam, Hong Kong

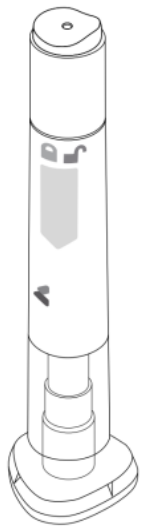

---

[11] 2321919.1M006

[15] 12-11-2022

[30] 27-10-2022 / US / 29/867,534

13-05-2022 / US / 29/838,534

27-10-2022 / US / 29/867,501

[51] Cl. 24-02

[54] 藥物輸送裝置

Medication delivery device

[73] ELI LILLY AND COMPANY

P.O. Box 6288,

Indianapolis, IN 46206-6288,

United States of America

[74] MARKS & CLERK  
Level 9, Cyberport 1,  
100 Cyberport Road,  
Pok Fu Lam, Hong Kong

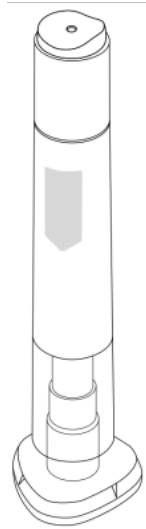

[11] 2321919.1M007

[15] 12-11-2022

[30] 27-10-2022 / US / 29/867,534

13-05-2022 / US / 29/838,534

27-10-2022 / US / 29/867,501

[51] Cl. 24-02

[54] 藥物輸送裝置

Medication delivery device

[73] ELI LILLY AND COMPANY

P.O. Box 6288,

Indianapolis, IN 46206-6288,

United States of America

[74] MARKS & CLERK

Level 9, Cyberport 1,

100 Cyberport Road,

Pok Fu Lam, Hong Kong

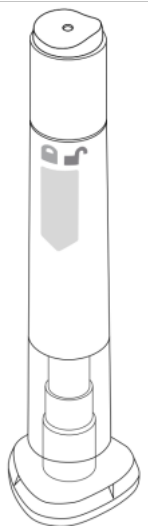

---

[11] 2423784.6

[15] 30-07-2024

[51] Cl. 9-05

[54] 特濃咖啡沖調包裝袋

Packaging bag for coffee espresso

[73] 陳志揚

CHAN CHI YEUNG BILLY

ESPRESSO FACTORY

SHOP 2, G/F, THE HEDON,

11 MATHESON STREET, CAUSEWAY BAY,

HONG KONG

[74] ESPRESSO FACTORY

SHOP 2, G/F, THE HEDON,

11 MATHESON STREET, CAUSEWAY BAY,

HONG KONG

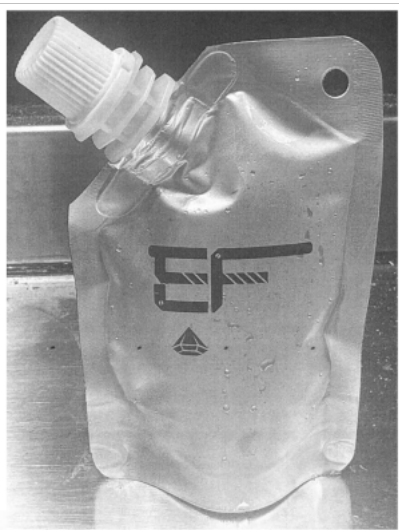



[11] 2423831.7

[15] 09-08-2024

[51] Cl. 3-01

[54] 珠寶盒

Jewel case

[73] 深圳迪凱工貿有限公司

Shenzhen Dikai Industrial Co., Ltd.

中國

深圳市寶安區新橋街道新橋社區

新橋崗仔大街 132 號第 10 棟廠房 9 層南面

[74] 智群科技設計(香港)有限公司

香港

九龍九龍灣宏光道 8 號

創豪坊 7 樓 706 室

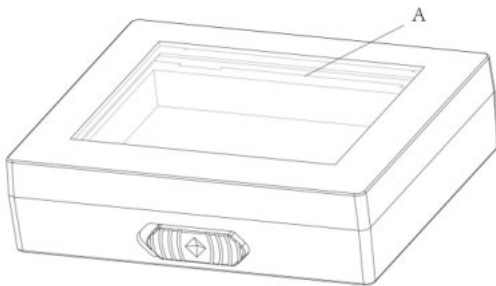

[11] 2423850.7

[15] 13-08-2024

[30] 12-04-2024 / CN / 2024302057117

[51] Cl. 23-04

[54] 煙機

Range hood

[73] 佛山市顺德区美的电热电器制造有限公司

中國

广东省佛山市顺德区

北滘镇三乐东路 19 号

[74] 香港派特恩知识产权代理有限公司

香港

上環永樂街 121-125 號

永達商業大廈 10 樓 C 室

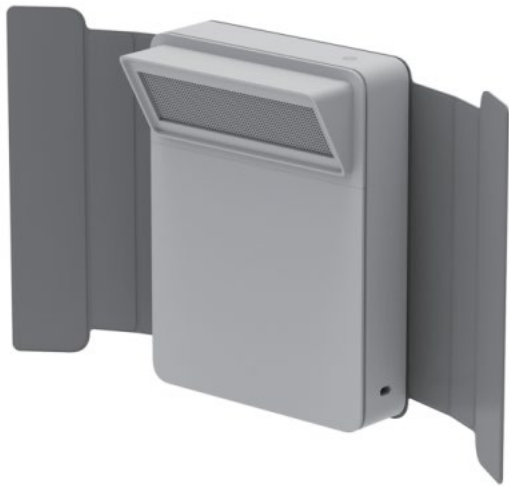

---

[11] 2424017.2

[15] 12-09-2024

[30] 22-05-2024 / KH, CA, AM, AZ, BZ, BA, GE, LI, MK, MD, MC, MN,  
ME, MA, NO, OM, RU, SG, CH, TN, TR, UA, GB, EU, AL, IL, KR, KG  
/ DM/238914

[51] Cl. 10-07

[54] 錶面  
Dial

[73] OMEGA SA (OMEGA AG) (OMEGA LTD.)  
Jakob-Stämpfli-Strasse 96,  
CH-2502 Biel/Bienne,  
SWITZERLAND

[74] SPRUSON & FERGUSON (HONG KONG) LIMITED  
5001 Hopewell Centre,  
183 Queen's Road East, Wan Chai,  
Hong Kong



- [11] 2424132.5M001  
[15] 27-09-2024  
[30] 29-03-2024 / US / 29/935,190  
[51] Cl. 9-07  
[54] 容器蓋  
Container lid  
[73] RUNWAY BLUE, LLC  
35 South Pfeifferhorn Drive,  
Alpine, Utah 84004,  
UNITED STATES OF AMERICA  
[74] ROUSE & CO. INTERNATIONAL (OVERSEAS) LIMITED  
26/F., Tesbury Centre,  
28 Queen's Road East,  
Hong Kong

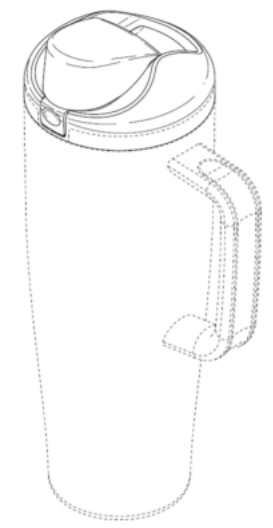

- 
- [11] 2424132.5M002  
[15] 27-09-2024  
[30] 29-03-2024 / US / 29/935,190  
[51] Cl. 9-01  
[54] 容器  
Container  
[73] RUNWAY BLUE, LLC  
35 South Pfeifferhorn Drive,  
Alpine, Utah 84004,  
UNITED STATES OF AMERICA  
[74] ROUSE & CO. INTERNATIONAL (OVERSEAS) LIMITED  
26/F., Tesbury Centre,  
28 Queen's Road East,  
Hong Kong

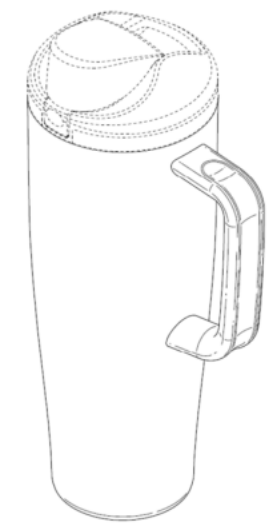

---

[11] 2424132.5M003

[15] 27-09-2024

[30] 29-03-2024 / US / 29/935,195

[51] Cl. 9-07

[54] 容器蓋

Container lid

[73] RUNWAY BLUE, LLC

35 South Pfeifferhorn Drive,

Alpine, Utah 84004,

UNITED STATES OF AMERICA

[74] ROUSE & CO. INTERNATIONAL (OVERSEAS) LIMITED

26/F., Tesbury Centre,

28 Queen's Road East,

Hong Kong

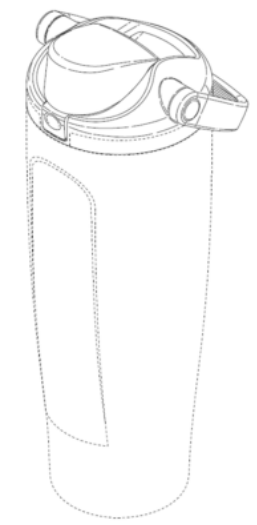

- [11] 2424132.5M004  
[15] 27-09-2024  
[30] 29-03-2024 / US / 29/935,195  
[51] Cl. 9-01  
[54] 容器  
Container  
[73] RUNWAY BLUE, LLC  
35 South Pfeifferhorn Drive,  
Alpine, Utah 84004,  
UNITED STATES OF AMERICA  
[74] ROUSE & CO. INTERNATIONAL (OVERSEAS) LIMITED  
26/F., Tesbury Centre,  
28 Queen's Road East,  
Hong Kong

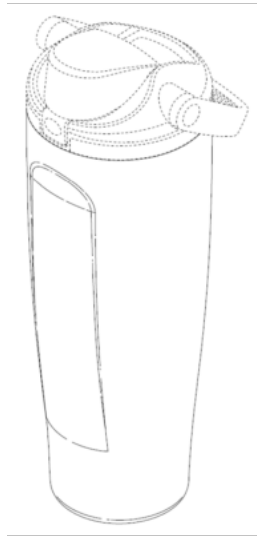

- [11] 2424141.4M001  
[15] 30-09-2024  
[51] Cl. 16-01  
[54] 相機  
Camera  
[73] 影石创新科技股份有限公司  
ARASHI VISION INC.  
中國  
广东省深圳市宝安区新安街道海旺社区兴业路  
1100号金利通金融中心大厦2栋1101,1102,1103  
[74] 香港派特恩知识产权代理有限公司  
香港  
上環永樂街121-125號  
永達商業大廈10樓C室

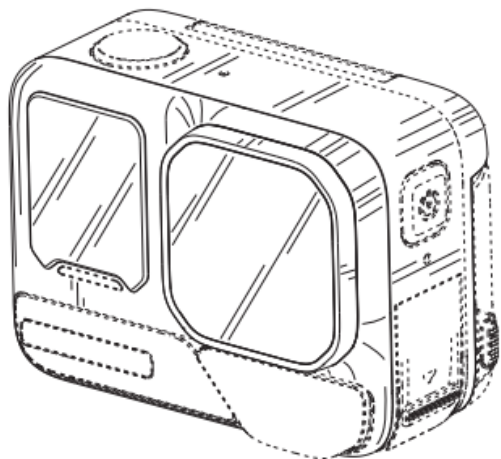

---

[11] 2424141.4M002

[15] 30-09-2024

[51] Cl. 16-01

[54] 相機

Camera

[73] 影石创新科技股份有限公司

ARASHI VISION INC.

中國

广东省深圳市宝安区新安街道海旺社区兴业路

1100号金利通金融中心大厦2栋1101,1102,1103

[74] 香港派特恩知识产权代理有限公司

香港

上環永樂街121-125號

永達商業大廈10樓C室

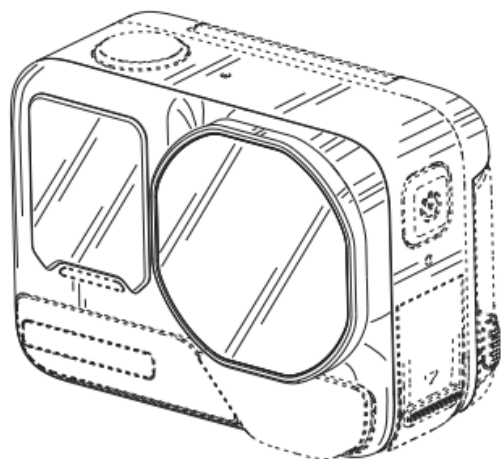

---

[11] 2424287.3M001

- [15] 15-10-2024
- [30] 01-05-2024 / US / 29/940,376
- [51] Cl. 26-05
- [54] 便攜式燈  
Portable light
- [73] Bocci Design & Manufacturing Inc.  
495 Railway St., Vancouver,  
British Columbia, V6A 1A7,  
CANADA
- [74] ELLALAN  
26th - 28th Floors, The Hennessy,  
256 Hennessy Road, Wanchai,  
Hong Kong

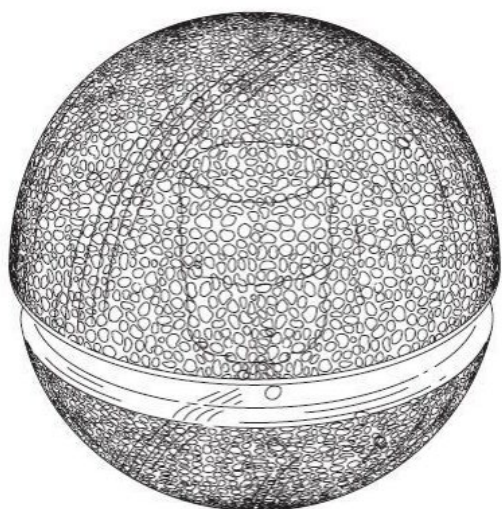

- 
- [11] 2424287.3M002
- [15] 15-10-2024
- [30] 01-05-2024 / US / 29/940,376
- [51] Cl. 26-05
- [54] 便攜式燈  
Portable light
- [73] Bocci Design & Manufacturing Inc.  
495 Railway St., Vancouver,  
British Columbia, V6A 1A7,  
CANADA
- [74] ELLALAN  
26th - 28th Floors, The Hennessy,  
256 Hennessy Road, Wanchai,  
Hong Kong



---

[11] 2424287.3M003

[15] 15-10-2024

[30] 01-05-2024 / US / 29/940,376

[51] Cl. 26-05

[54] 便攜式燈

Portable light

[73] Bocci Design & Manufacturing Inc.

495 Railway St., Vancouver,

British Columbia, V6A 1A7,

CANADA

[74] ELLALAN

26th - 28th Floors, The Hennessy,

256 Hennessy Road, Wanchai,

Hong Kong





- [11] 2424400.4  
[15] 22-10-2024  
[30] 22-04-2024 / EU / 015058375-0015  
[51] Cl. 12-16  
[54] 後保險槓  
Vehicle rear bumper  
[73] 蔚来汽车科技(安徽)有限公司  
NIO Technology (Anhui) Co., Ltd  
中國  
安徽省合肥市经济技术开发区宿松路 3963 号  
恒创智能科技园 F 幢  
[74] 中一聯合國際知識產權有限公司  
香港  
九龍觀塘興業街 20 號  
聯合興業工業大廈 5 樓 A26 室



- 
- [11] 2424401.6  
[15] 22-10-2024  
[30] 22-04-2024 / EU / 015058375-0009  
[51] Cl. 12-16  
[54] 前保險槓  
Vehicle front bumper  
[73] 蔚来汽车科技(安徽)有限公司  
NIO Technology (Anhui) Co., Ltd  
中國  
安徽省合肥市经济技术开发区宿松路 3963 号  
恒创智能科技园 F 幢  
[74] 中一聯合國際知識產權有限公司  
香港

九龍觀塘興業街 20 號  
聯合興業工業大廈 5 樓 A26 室

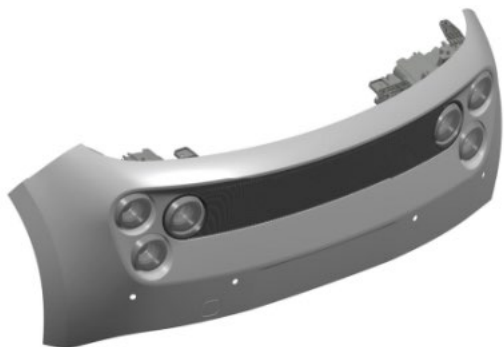

---

[11] 2424521.1

[15] 13-11-2024

[30] 16-08-2024 / US / 29/957,945

[51] Cl. 28-03

[54] 化妝品盒

Cosmetic case

[73] Beauty Molecules International Limited

No.3, 10 Cadogan Square,

London SW1X 0JU,

UNITED KINGDOM

[74] TRADEMARKCN COMPANY LIMITED

Block A, 4/F., Granville Building,

14 Granville Road, Tsim Sha Tsui, Kowloon,

HONG KONG

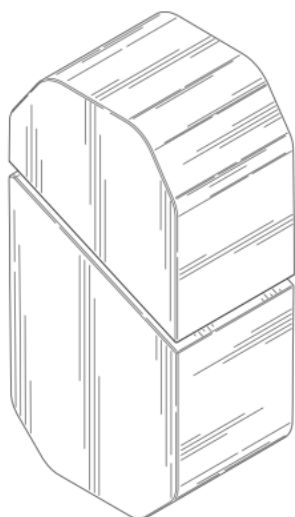

- [11] 2424522.3  
[15] 13-11-2024  
[30] 13-05-2024 / US / 29/941,917  
[51] Cl. 28-03  
[54] 可再填充化妝品盒的托盤  
Tray for a refillable cosmetic compact  
[73] ELC MANAGEMENT LLC  
155 Pinelawn Road,  
Suite 345 South,  
Melville, NY 11747,  
UNITED STATES OF AMERICA  
[74] CHINA PATENT AGENT (HONG KONG) LIMITED  
22/F, Great Eagle Centre,  
23 Harbour Road, Wanchai,  
HONG KONG

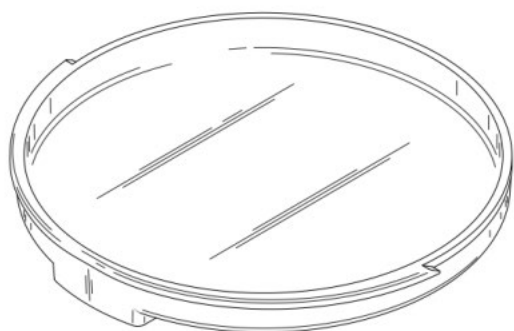

- 
- [11] 2424540.1  
[15] 14-11-2024  
[30] 24-06-2024 / CN / 2024303888847  
[51] Cl. 3-01  
[54] 膠套  
Protective sleeve  
[73] 伊贝斯国际控股有限公司  
E-BEST HOLDING COMPANY LIMITED  
RM. 1805, NANYANG PLAZA,  
57 HUNG TO ROAD, KL.,  
HONG KONG, CHINA  
[74] ACCOLADE IP LIMITED  
Unit 2406B, 24/F, Low Block,  
Grand Millennium Plaza,  
181 Queen's Road Central,  
Sheung Wan, HONG KONG

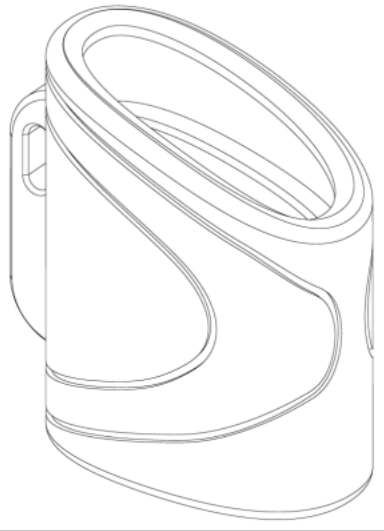

[11] 2424595.7

[15] 25-11-2024

[51] C1. 9-03

[54] 包裝盒  
Packing box

[73] 香港热科农业科技有限公司  
HONG KONG RAKO AGROTECH LIMITED  
中國  
香港上環德輔道西 81-85 號  
潮州會館 302 室

[74] LISHI INTELLECTUAL PROPERTY GROUP (INTERNATIONAL) LIMITED  
香港  
九龍尖沙咀中心東翼  
10 樓 1013 室



[11] 2424610.0

[15] 27-11-2024

[51] Cl. 28-06

[54] 吹風機

Hair dryer

[73] 渲美美健(深圳)科技股份有限公司

TOUCHBEAUTY BEAUTY & HEALTH (SHENZHEN) CO., LTD

中國

廣東省深圳市南山區粵海街道

海珠社區海德三道 195 號

天利中央商務廣場(二期) B2901

[74] 海思国际知识产权有限公司

香港

九龍觀塘道 348 號

宏利廣場 6 樓

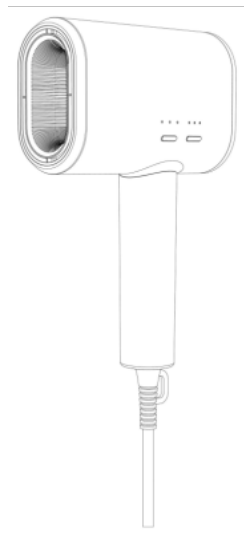

[11] 2424634.0

[15] 29-11-2024

[51] Cl. 3-01

[54] 皮革卡片套

Leather card holder

[73] 郭盛熙

Kwok Shing Hei

香港

灣仔皇后大道東 127 號

三樓後座

[74] 郭盛熙

香港

灣仔皇后大道東 127 號

三樓後座

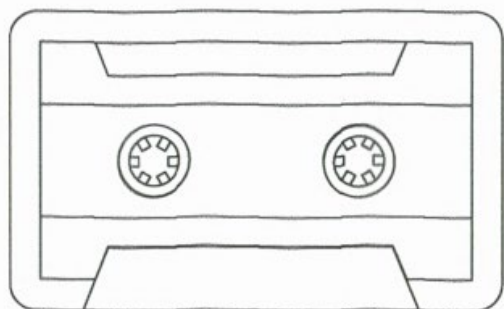

---

[11] 2424668.2M001

[15] 05-12-2024

[30] 06-06-2024 / JP / 2024-011468

[51] Cl. 12-12

[54] 嬰兒車

Baby carriage

[73] 康貝株式會社

Combi Corporation

6-7, Motoasakusa 2-chome,

Taito-ku, Tokyo 111-0041,

JAPAN

[74] DELONG INTELLECTUAL PROPERTY GROUP (HONG KONG) CO., LIMITED

Unit D, 29/F, Morrison Plaza,

9 Morrison Hill Road, WAN CHAI,

HONG KONG



---

[11] 2424668.2M002

[15] 05-12-2024

[30] 06-06-2024 / JP / 2024-011469

[51] Cl. 12-12

[54] 嬰兒車

Baby carriage

[73] 康貝株式會社

Combi Corporation

6-7, Motoasakusa 2-chome,

Taito-ku, Tokyo 111-0041,

JAPAN

[74] DELONG INTELLECTUAL PROPERTY GROUP (HONG KONG) CO., LIMITED

Unit D, 29/F, Morrison Plaza,

9 Morrison Hill Road, WAN CHAI,

HONG KONG



---

[11] 2424668.2M003

[15] 05-12-2024

[30] 06-06-2024 / JP / 2024-011470

[51] Cl. 12-12

[54] 嬰兒車

Baby carriage

[73] 康貝株式會社

Combi Corporation

6-7, Motoasakusa 2-chome,

Taito-ku, Tokyo 111-0041,

JAPAN

[74] DELONG INTELLECTUAL PROPERTY GROUP (HONG KONG) CO., LIMITED

Unit D, 29/F, Morrison Plaza,

9 Morrison Hill Road, WAN CHAI,

HONG KONG



---

[11] 2424677.1M001

[15] 06-12-2024

[30] 07-06-2024 / CN / 2024303516859

[51] Cl. 14-03

[54] 會議設備

Conference equipment

[73] 影石创新科技股份有限公司

ARASHI VISION INC.

中國

广东省深圳市宝安区新安街道海旺社区

兴业路 1100 号金利通金融中心大厦

2 栋 1101, 1102, 1103

[74] 香港派特恩知识产权代理有限公司

香港

上環永樂街 121-125 號

永達商業大廈 10 樓 C 室

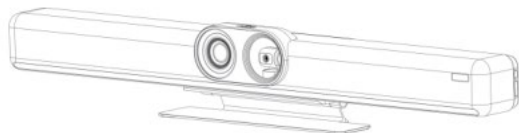

---

[11] 2424677.1M002

[15] 06-12-2024

[30] 07-06-2024 / CN / 2024303516859

[51] Cl. 14-03

[54] 會議設備

Conference equipment



[73] 影石创新科技股份有限公司  
ARASHI VISION INC.  
中國  
广东省深圳市宝安区新安街道海旺社区  
兴业路 1100 号金利通金融中心大厦  
2 栋 1101,1102,1103

[74] 香港派特恩知识产权代理有限公司  
香港  
上環永樂街 121-125 號  
永達商業大廈 10 樓 C 室



---

[11] 2424682.1

[15] 09-12-2024

[30] 13-06-2024 / US / 29/947,278

[51] Cl. 3-01

[54] 耳塞式耳機收納盒  
Case for earbud headphones

[73] Skullcandy, Inc.  
6301 N. Landmark Drive,  
Park City, UT 84098,  
UNITED STATES OF AMERICA

[74] CLT PATENT & TRADEMARK (H.K.) LIMITED  
Unit 09, 34/F., Office Tower,  
Convention Plaza, 1 Harbour Road,  
Wanchai, HONG KONG

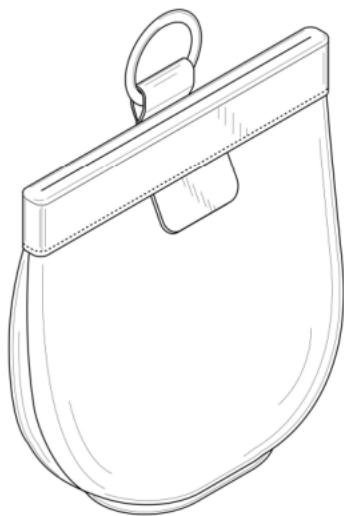

- [11] 2424714.0  
[15] 13-12-2024  
[30] 16-07-2024 / JP / 2024-014548  
[51] Cl. 9-05  
[54] 包裝袋  
Packing pouch  
[73] 久光製藥株式會社  
HISAMITSU PHARMACEUTICAL CO., INC.  
408, Tashirodaikan-machi,  
Tosu-shi, Saga 841-0017,  
JAPAN  
[74] WILKINSON & GRIST  
11/F, Great Eagle Centre,  
23 Harbour Road,  
HONG KONG
- 



- [11] 2424781.1M001  
[15] 19-12-2024  
[30] 19-07-2024 / KH, CA, AM, AZ, BZ, BA, GE, LI, MK, MD, MC, MN,  
ME, MA, NO, OM, SG, CH, TN, TR, UA, GB, EU, AL, IL, KR, KG /  
DM/238886  
[51] Cl. 11-01  
[54] 項鍊  
Necklace  
[73] Harry Winston SA  
Chemin du Tourbillon 8,  
CH-1228 Plan-les-Ouates,  
SWITZERLAND
-

[74] SPRUSON & FERGUSON (HONG KONG) LIMITED  
5001 Hopewell Centre,  
183 Queen's Road East,  
Wan Chai, HONG KONG



---

[11] 2424781.1M002

[15] 19-12-2024

[30] 19-07-2024 / KH, CA, AM, AZ, BZ, BA, GE, LI, MK, MD, MC, MN,  
ME, MA, NO, OM, SG, CH, TN, TR, UA, GB, EU, AL, IL, KR, KG /  
DM/238886

[51] Cl. 11-01

[54] 耳環

Earrings

[73] Harry Winston SA  
Chemin du Tourbillon 8,  
CH-1228 Plan-les-Ouates,  
SWITZERLAND

[74] SPRUSON & FERGUSON (HONG KONG) LIMITED  
5001 Hopewell Centre,  
183 Queen's Road East,  
Wan Chai, HONG KONG



---

[11] 2424781.1M003

[15] 19-12-2024

[30] 19-07-2024 / KH, CA, AM, AZ, BZ, BA, GE, LI, MK, MD, MC, MN,  
ME, MA, NO, OM, SG, CH, TN, TR, UA, GB, EU, AL, IL, KR, KG /  
DM/238886

[51] Cl. 11-01

[54] 指環  
Ring

[73] Harry Winston SA  
Chemin du Tourbillon 8,  
CH-1228 Plan-les-Ouates,  
SWITZERLAND

[74] SPRUSON & FERGUSON (HONG KONG) LIMITED  
5001 Hopewell Centre,  
183 Queen's Road East,  
Wan Chai, HONG KONG



---

[11] 2424781.1M004

[15] 19-12-2024

[30] 19-07-2024 / KH, CA, AM, AZ, BZ, BA, GE, LI, MK, MD, MC, MN,  
ME, MA, NO, OM, SG, CH, TN, TR, UA, GB, EU, AL, IL, KR, KG /  
DM/238886

[51] Cl. 11-01

[54] 項鍊  
Necklace

[73] Harry Winston SA  
Chemin du Tourbillon 8,  
CH-1228 Plan-les-Ouates,  
SWITZERLAND

[74] SPRUSON & FERGUSON (HONG KONG) LIMITED  
5001 Hopewell Centre,  
183 Queen's Road East,  
Wan Chai, HONG KONG



[11] 2424781.1M005

[15] 19-12-2024

[30] 19-07-2024 / KH, CA, AM, AZ, BZ, BA, GE, LI, MK, MD, MC, MN, ME, MA, NO, OM, SG, CH, TN, TR, UA, GB, EU, AL, IL, KR, KG / DM/238886

[51] Cl. 11-01

[54] 耳環

Earrings

[73] Harry Winston SA

Chemin du Tourbillon 8,  
CH-1228 Plan-les-Ouates,  
SWITZERLAND

[74] SPRUSON & FERGUSON (HONG KONG) LIMITED

5001 Hopewell Centre,  
183 Queen's Road East,  
Wan Chai, HONG KONG

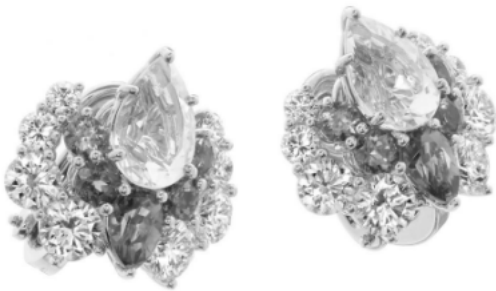

[11] 2424781.1M006

[15] 19-12-2024

[30] 19-07-2024 / KH, CA, AM, AZ, BZ, BA, GE, LI, MK, MD, MC, MN, ME, MA, NO, OM, SG, CH, TN, TR, UA, GB, EU, AL, IL, KR, KG / DM/238886

[51] Cl. 11-01

[54] 項鍊

Necklace

[73] Harry Winston SA  
Chemin du Tourbillon 8,  
CH-1228 Plan-les-Ouates,  
SWITZERLAND

[74] SPRUSON & FERGUSON (HONG KONG) LIMITED  
5001 Hopewell Centre,  
183 Queen's Road East,  
Wan Chai, HONG KONG



---

[11] 2424796.3M001

[15] 24-12-2024

[51] Cl. 7-02

[54] 小吃造型用托盤  
Tray for snack molding

[73] 客樂譜株式會社  
Kracie, Ltd.  
20-20, Kaigan 3-chome,  
Minato-ku, Tokyo,  
JAPAN

[74] UNION PATENT SERVICE CENTRE  
Units E-F, 20th Floor,  
Neich Tower, 128 Gloucester Road,  
HONG KONG

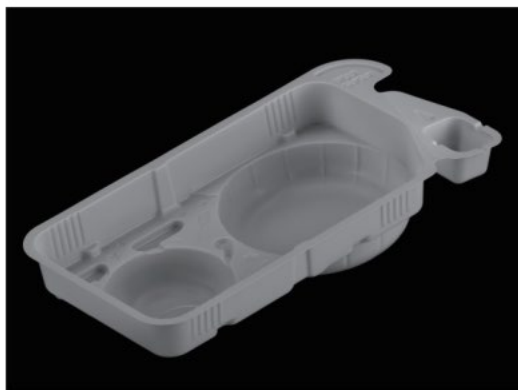

---

[11] 2424796.3M002

[15] 24-12-2024

[51] Cl. 7-02

[54] 小吃造型用托盤

Tray for snack molding

[73] 客樂譜株式會社

Kracie, Ltd.

20-20, Kaigan 3-chome,

Minato-ku, Tokyo,

JAPAN

[74] UNION PATENT SERVICE CENTRE

Units E-F, 20th Floor,

Neich Tower, 128 Gloucester Road,

HONG KONG



---

[11] 2424797.5

[15] 24-12-2024

[51] Cl. 7-02

[54] 小吃造型用托盤

Tray for snack molding

[73] 客樂譜株式會社

Kracie, Ltd.

20-20, Kaigan 3-chome,

Minato-ku, Tokyo,

JAPAN

[74] UNION PATENT SERVICE CENTRE

Units E-F, 20th Floor,

Neich Tower, 128 Gloucester Road,

HONG KONG



---

[11] 2424798.7M001

[15] 24-12-2024

[51] Cl. 9-05

[54] 包裝用袋  
Packaging bag

[73] 客樂譜株式會社  
Kracie, Ltd.  
20-20, Kaigan 3-chome,  
Minato-ku, Tokyo,  
JAPAN

[74] UNION PATENT SERVICE CENTRE  
Units E-F, 20th Floor,  
Neich Tower, 128 Gloucester Road,  
HONG KONG



---

[11] 2424798.7M002

[15] 24-12-2024

[51] Cl. 9-05

[54] 包裝用袋  
Packaging bag



[73] 客樂譜株式會社

Kracie, Ltd.

20-20, Kaigan 3-chome,

Minato-ku, Tokyo,

JAPAN

[74] UNION PATENT SERVICE CENTRE

Units E-F, 20th Floor,

Neich Tower, 128 Gloucester Road,

HONG KONG



[11] 2424803.9

[15] 24-12-2024

[51] Cl. 24-01

[54] 內窺鏡操作站

A station for operating an endoscope

[73] Agilis Robotics Limited

Room 630, 6/F, Block 17,

Science Park West Avenue,

Pak Shek Kok, HONG KONG

[74] LECTO IP LIMITED

Unit 503, 5/F, Tower 2 Lippo Centre,

89 Queensway, Admiralty,

HONG KONG

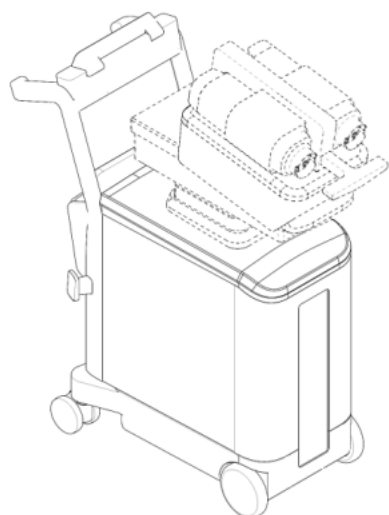

---

[11] 2424805.4

[15] 27-12-2024

[30] 18-11-2024 / US / 29/973,761

[51] Cl. 2-04

[54] 中底週邊

Midsole periphery

[73] Skechers U.S.A., Inc. II  
228 Manhattan Beach Blvd.,  
Manhattan Beach, CA 90266,  
UNITED STATES OF AMERICA

[74] P C WOO & CO  
ROOM 1225, 12/F.,  
PRINCE'S BUILDING,  
10 CHATER ROAD,  
CENTRAL, HONG KONG



---

[11] 2424806.6

[15] 27-12-2024

[30] 18-11-2024 / US / 29/973,750

[51] Cl. 2-04

[54] 外底底部

Outsole bottom

[73] Skechers U.S.A., Inc. II  
228 Manhattan Beach Blvd.,  
Manhattan Beach, CA 90266,  
UNITED STATES OF AMERICA

[74] P C WOO & CO  
ROOM 1225, 12/F.,  
PRINCE'S BUILDING,  
10 CHATER ROAD,  
CENTRAL, HONG KONG



---

[11] 2424808.0

[15] 27-12-2024

[30] 07-11-2024 / JP / 2024-023096

[51] Cl. 21-01

[54] 立體金屬拼圖

3-Dimensional metallic puzzle

[73] 華山國際貿易有限公司  
Hanayama International Trading Limited  
Flat A, 7/F, NO.1 Chatham Road South,  
Tsim Sha Tsui, Kowloon,  
HONG KONG

[74] Ms Cansi Wong  
Flat A, 7/F, No.1 Chatham Road South,  
Tsim Sha Tsui, Kowloon,  
HONG KONG



---

[11] 2424809.2

[15] 27-12-2024

[51] Cl. 11-01

[54] 戒指  
Ring

[73] 周大福珠寶金行(深圳)有限公司  
Chow Tai Fook Jewellery (Shenzhen) Company Limited  
中國  
廣東省深圳市鹽田區深鹽路  
黃金珠寶大廈 12 樓 A 座

[74] 天標知識產權代理有限公司  
香港  
九龍尖沙咀加連威老道 14 號  
加連威大廈 4 樓 A 座



---

[11] 2424810.4

[15] 27-12-2024

[51] Cl. 11-01

[54] 戒指  
Ring

[73] 周大福珠寶金行(深圳)有限公司  
Chow Tai Fook Jewellery (Shenzhen) Company Limited  
中國  
廣東省深圳市鹽田區深鹽路  
黃金珠寶大廈 12 樓 A 座

[74] 天標知識產權代理有限公司  
香港  
九龍尖沙咀加連威老道 14 號  
加連威大廈 4 樓 A 座



---

[11] 2424811.6

[15] 27-12-2024

[51] Cl. 11-01

[54] 戒指  
Ring

[73] 周大福珠寶金行(深圳)有限公司  
Chow Tai Fook Jewellery (Shenzhen) Company Limited  
中國  
廣東省深圳市鹽田區深鹽路  
黃金珠寶大廈 12 樓 A 座

[74] 天標知識產權代理有限公司  
香港  
九龍尖沙咀加連威老道 14 號  
加連威大廈 4 樓 A 座



---

[11] 2424817.9

[15] 27-12-2024

[30] 18-07-2024 / KH, CA, EG, AM, AZ, BZ, BA, GE, LI, MK, MD, MC, MN, ME, MA, NO, OM, RU, RS, SG, CH, TN, TR, UA, GB, VN, EU, AL, IL, KR, KG / DM/240032

[51] Cl. 10-02

[54] 錶

Watch

[73] OMEGA SA (OMEGA AG) (OMEGA LTD.)

Jakob-Stämpfli-Strasse 96,

CH-2502 Biel/Bienne,

SWITZERLAND

[74] SPRUSON & FERGUSON (HONG KONG) LIMITED

5001 Hopewell Centre,

183 Queen's Road East,

Wan Chai, HONG KONG



---

[11] 2424818.1

[15] 27-12-2024

[51] Cl. 7-07

[54] 拖把桶

Mop bucket

[73] 慈溪市博生塑料制品有限公司

CIXI BOSHEG PLASTIC CO., LTD.

中國

浙江省慈溪市

龙山镇东渡村, 315331

[74] 百睿知識產權有限公司

香港

新界沙田香港科學園

科技大道西 10 號浚湖樓 617 室



---

[11] 2424819.3

[15] 30-12-2024

[51] Cl. 23-01

[54] 面盆水龍頭

Basin faucet

[73] 蔡茂雄

CHOI MOU HUNG

香港

粉嶺坪洋村

DD79 HOUSE

LOT 127 號

[74] 蔡茂雄

香港

火炭禾寮坑路 2-16 號

安盛工業大廈 1 樓 B 室



[11] 2424820.5

[15] 30-12-2024

[51] Cl. 23-01

[54] 高身面盆水龍頭  
High basin faucet

[73] 蔡茂雄  
CHOI MOU HUNG  
香港  
粉嶺坪洋村  
DD79 HOUSE  
LOT 127 號

[74] 蔡茂雄  
香港  
火炭禾寮坑路 2-16 號  
安盛工業大廈 1 樓 B 室





- [11] 2424827.0  
[15] 31-12-2024  
[30] 11-07-2024 / CA, MX, OM, SG, CH, TR, GB, VN, EU, IL /  
DM/239317  
[51] Cl. 10-02  
[54] 錶  
Watch  
[73] RADO UHREN AG (RADO WATCH CO. LTD.) (MONTRES RADO SA)  
Bielstrasse 45,  
CH-2543 Lengnau,  
SWITZERLAND  
[74] SPRUSON & FERGUSON (HONG KONG) LIMITED  
5001 Hopewell Centre,  
183 Queen's Road East,  
Wan Chai, HONG KONG



- [11] 2424828.2M001  
[15] 31-12-2024  
[30] 05-07-2024 / KR / 30-2024-0026607  
[51] Cl. 9-05  
[54] 食品包裝袋  
Bag for food packing  
[73] CJ 第一製糖株式會社  
CJ CHEILJEDANG CORPORATION  
(Ssangnim-dong) 330, Dongho-ro,  
Jung-gu, Seoul 04560  
REPUBLIC OF KOREA  
[74] GLOBAL ZEN IP SERVICES LIMITED  
Room 1707, 17th Floor, Beverly House,  
93-107 Lockhart Road, Wanchai,  
HONG KONG



[11] 2424828.2M002

[15] 31-12-2024

[30] 05-07-2024 / KR / 30-2024-0026608

[51] Cl. 9-05

[54] 食品包裝袋

Bag for food packing

[73] CJ 第一製糖株式會社

CJ CHEILJEDANG CORPORATION

(Ssangnim-dong) 330, Dongho-ro,

Jung-gu, Seoul 04560

REPUBLIC OF KOREA

[74] GLOBAL ZEN IP SERVICES LIMITED

Room 1707, 17th Floor, Beverly House,

93-107 Lockhart Road, Wanchai,

HONG KONG



- [11] 2424828.2M003  
[15] 31-12-2024  
[30] 05-07-2024 / KR / 30-2024-0026609  
[51] Cl. 9-05  
[54] 食品包裝袋  
Bag for food packing  
[73] CJ 第一製糖株式會社  
CJ CHEILJEDANG CORPORATION  
(Ssangnim-dong) 330, Dongho-ro,  
Jung-gu, Seoul 04560  
REPUBLIC OF KOREA  
[74] GLOBAL ZEN IP SERVICES LIMITED  
Room 1707, 17th Floor, Beverly House,  
93-107 Lockhart Road, Wanchai,  
HONG KONG



- [11] 2424828.2M004  
[15] 31-12-2024  
[30] 05-07-2024 / KR / 30-2024-0026610  
[51] Cl. 9-05  
[54] 食品包裝袋  
Bag for food packing  
[73] CJ 第一製糖株式會社  
CJ CHEILJEDANG CORPORATION  
(Ssangnim-dong) 330, Dongho-ro,  
Jung-gu, Seoul 04560  
REPUBLIC OF KOREA  
[74] GLOBAL ZEN IP SERVICES LIMITED  
Room 1707, 17th Floor, Beverly House,

93-107 Lockhart Road, Wanchai,  
HONG KONG



[11] 2424828.2M005

[15] 31-12-2024

[30] 05-07-2024 / KR / 30-2024-0026611

[51] Cl. 9-05

[54] 食品包裝袋  
Bag for food packing

[73] CJ 第一製糖株式會社  
CJ CHEILJEDANG CORPORATION  
(Ssangnim-dong) 330, Dongho-ro,  
Jung-gu, Seoul 04560  
REPUBLIC OF KOREA

[74] GLOBAL ZEN IP SERVICES LIMITED  
Room 1707, 17th Floor, Beverly House,  
93-107 Lockhart Road, Wanchai,  
HONG KONG



[11] 2424829.4M001

[15] 31-12-2024

[51] Cl. 11-01

[54] 珠寶飾品  
Jewellery ornament

[73] 周大福珠宝金行(深圳)有限公司  
CHOW TAI FOOK JEWELLERY (SHENZHEN) CO., LTD.  
中國  
广东省深圳市盐田区深盐路  
黄金珠宝大厦 12 楼 A 座

[74] 中一聯合國際知識產權有限公司  
香港  
九龍觀塘興業街 20 號  
聯合興業工業大廈 5 樓 A26 室



[11] 2424829.4M002

[15] 31-12-2024

[51] Cl. 11-01

[54] 珠寶飾品

Jewellery ornament

[73] 周大福珠宝金行(深圳)有限公司

CHOW TAI FOOK JEWELLERY (SHENZHEN) CO., LTD.

中國

广东省深圳市盐田区深盐路

黄金珠宝大厦 12 楼 A 座

[74] 中一聯合國際知識產權有限公司

香港

九龍觀塘興業街 20 號

聯合興業工業大廈 5 樓 A26 室



[11] 2424829.4M003

[15] 31-12-2024

[51] Cl. 11-01

[54] 珠寶飾品

Jewellery ornament

[73] 周大福珠宝金行(深圳)有限公司

CHOW TAI FOOK JEWELLERY (SHENZHEN) CO., LTD.

中國

广东省深圳市盐田区深盐路

黄金珠宝大厦 12 楼 A 座

[74] 中一聯合國際知識產權有限公司

香港

九龍觀塘興業街 20 號  
聯合興業工業大廈 5 樓 A26 室

---



---

[11] 2424829.4M004

[15] 31-12-2024

[51] Cl. 11-01

[54] 珠寶飾品  
Jewellery ornament

[73] 周大福珠寶金行(深圳)有限公司  
CHOW TAI FOOK JEWELLERY (SHENZHEN) CO., LTD.  
中國  
廣東省深圳市鹽田區深鹽路  
黃金珠寶大廈 12 樓 A 座

[74] 中一聯合國際知識產權有限公司  
香港  
九龍觀塘興業街 20 號  
聯合興業工業大廈 5 樓 A26 室



[11] 2424829.4M005

[15] 31-12-2024

[51] Cl. 11-01

[54] 珠寶飾品  
Jewellery ornament

[73] 周大福珠宝金行(深圳)有限公司  
CHOW TAI FOOK JEWELLERY (SHENZHEN) CO., LTD.  
中國  
广东省深圳市盐田区深盐路  
黄金珠宝大厦 12 楼 A 座

[74] 中一聯合國際知識產權有限公司  
香港  
九龍觀塘興業街 20 號  
聯合興業工業大廈 5 樓 A26 室





[11] 2424829.4M006

[15] 31-12-2024

[51] Cl. 11-01

[54] 珠寶飾品

Jewellery ornament

[73] 周大福珠宝金行(深圳)有限公司

CHOW TAI FOOK JEWELLERY (SHENZHEN) CO., LTD.

中國

广东省深圳市盐田区深盐路

黄金珠宝大厦 12 楼 A 座

[74] 中一聯合國際知識產權有限公司

香港

九龍觀塘興業街 20 號

聯合興業工業大廈 5 樓 A26 室



[11] 2424835.7M001

[15] 31-12-2024

[30] 02-07-2024 / AU / 202414503

[51] Cl. 14-06

[54] 用於移動電子裝置的支架

Mount for a mobile electronic device

[73] ANNEX PRODUCTS PTY LTD

Suite 6A, Level 3,

299 Toorak Road,

South Yarra VIC 3141,

AUSTRALIA

[74] CHINAHONGKONG IP LIMITED

1502, 15/F, Capital Centre,

151 Gloucester Road,

Wanchai, HONG KONG

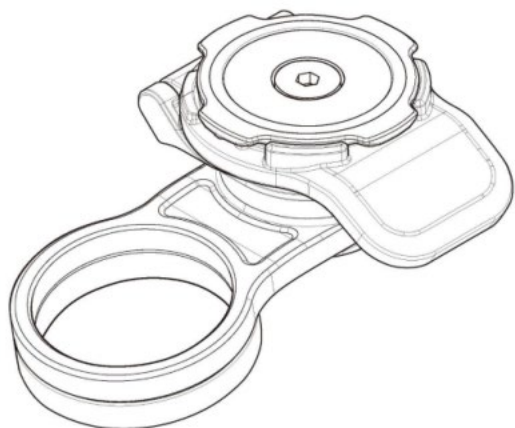

---

[11] 2424835.7M002

[15] 31-12-2024

[30] 02-07-2024 / AU / 202414503

[51] Cl. 14-06

[54] 用於移動電子裝置的支架

Mount for a mobile electronic device

[73] ANNEX PRODUCTS PTY LTD

Suite 6A, Level 3,

299 Toorak Road,

South Yarra VIC 3141,

AUSTRALIA

[74] CHINAHONGKONG IP LIMITED

1502, 15/F, Capital Centre,

151 Gloucester Road,

Wanchai, HONG KONG

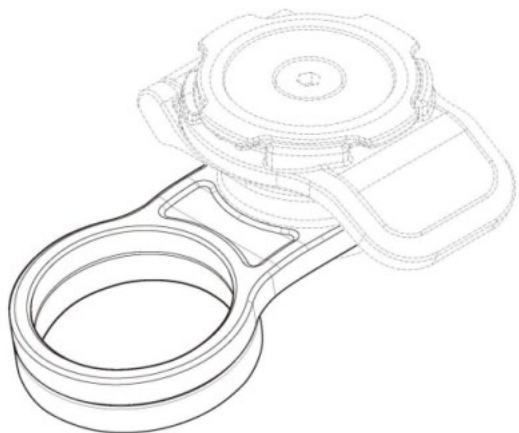



香港特別行政區政府知識產權署外觀設計註冊處

The Government of the Hong Kong Special Administrative Region

Designs Registry, Intellectual Property Department

根據註冊外觀設計條例第 28 條，下列註冊外觀設計因未繳續期費而停止有效。

各組記項按註冊外觀設計停止有效日期及註冊編號先後次序排列。

**Registered designs ceased through non-payment of renewal fees under section 28 of the Registered Designs Ordinance. Entries are listed below under their expiry dates.**

**16-01-2025 - 19-01-2025****16-01-2025**

2015444.1	2015451.6M001
2015447.8M001	2015451.6M002
2015447.8M002	2015451.6M003
	2015451.6M004
	2015451.6M005

**17-01-2025**

1000087.5	2015451.6M006
	2015456.7M001
	2015456.7M002

**18-01-2025**

1000102.8	2015457.9
1500134.0M001	2015458.1M001
1500134.0M002	2015458.1M002
1500144.1M001	
1500144.1M002	
1500144.1M003	
1500144.1M004	
1500144.1M005	
1500144.1M006	
1500144.1M007	
1500144.1M008	
1500144.1M009	
2015450.4M001	
2015450.4M002	

**19-01-2025**

0500142.5M001
0500142.5M002
0500142.5M003
0500142.5M004
0500142.5M005
1000123.2
1500146.6
1500148.0M001
1500148.0M002



香港特別行政區政府知識產權署外觀設計註冊處

The Government of the Hong Kong Special Administrative Region

Designs Registry, Intellectual Property Department

根據註冊外觀設計規則第 31 條刪除的註冊外觀設計。各組記項按註冊外觀設計刪除日期及註冊編號先後次序排列。

**Registered designs removed under section 31 of the Registered Designs Rules. Entries are listed below under their removal dates.**

**24-01-2025 - 26-01-2025**

**24-01-2025**

1914261.9M001

1914261.9M002

1914262.1

1914268.4

**25-01-2025**

1401346.0

1401349.6

1401350.8

1401351.0M001

1401351.0M002

1401351.0M003

1401351.0M004

1401351.0M006

1914271.0

1914272.2

1914273.4

1914275.9

**26-01-2025**

1914281.1



香港特別行政區政府知識產權署外觀設計註冊處

The Government of the Hong Kong Special Administrative Region

Designs Registry, Intellectual Property Department

## 根據註冊外觀設計條例第 76 條，更正已提交文件中的錯誤

### **Correction of errors in filed documents under section 76 of the Registered Designs Ordinance**

下列在 06.12.2024 官方公報刊登的更正錯誤的請求已在 07.02.2025 獲准許

The following request for correction of error advertised in the official journal on 06.12.2024 was allowed on 07.02.2025

[21] 2423943.4M011

[55] 外觀設計的表述

Representations of the Design