

香港知識產權公報

Hong Kong Intellectual Property Journal

2024年4月19日

19 April 2024



目錄 Contents

根據註冊外觀設計條例第 25 條註冊的外觀設計

Designs Registered under section 25 of the Registered Designs Ordinance

按註冊編號排列

Arranged by Registration Number

根據註冊外觀設計條例(第 522 章)公布的其他公告

Other Notices Published under the Registered Designs Ordinance (Cap. 522)

根據註冊外觀設計條例第 28 條，註冊外觀設計因未繳續期費而停止有效

Registered designs ceased through non-payment of renewal fees under section 28 of the Registered Designs Ordinance

根據註冊外觀設計規則第 31 條刪除的註冊外觀設計

Registered designs removed under section 31 of the Registered Designs Rules

根據註冊外觀設計條例第 76 條，更正已提交文件中的錯誤

Correction of errors in filed documents under section 76 of the Registered Designs Ordinance

以下事項沒有記錄

No Records for the Following Matters

根據註冊外觀設計條例第 30 條放棄的外觀設計的註冊

Surrender of Registration of Design under section 30 of the Registered Designs Ordinance

根據註冊外觀設計規則第 37 條，向處長作出轉介

Reference to Registrar under section 37 of the Registered Designs Rules

根據註冊外觀設計條例第 45 條，撤銷註冊

Revocation of Registration under section 45 of the Registered Designs Ordinance

根據註冊外觀設計規則第 46 條，向法院作出轉介

Reference to Court under section 46 of the Registered Designs Rules

根據註冊外觀設計規則第 63 條對不符合規定之處作出糾正

Rectification of Irregularities under section 63 of the Registered Designs Rules

根據註冊外觀設計條例第 66 條，糾正註冊紀錄冊

Rectification of Register under section 66 of the Registered Designs Ordinance

根據註冊外觀設計條例第 67 條 更正註冊紀錄冊內的錯誤

Correction of errors in Register under section 67 of the Registered Designs Ordinance

根據註冊外觀設計條例第 67 及 76 條，更正註冊紀錄冊內及已提交文件中的錯誤

Correction of Errors in Register and in Filed Documents under sections 67 and 76 of the Registered Designs Ordinance

勘誤

Corrigendum

註冊外觀設計公告註釋

Notes on advertisements of registration of designs

方括號表示下列資料：

Square brackets indicate the following data：

[11] 註冊編號 Registration number / 聯合王國註冊編號 United Kingdom registration number

[15] 註冊日期 Registration date / 當作註冊日期 Deemed registration date / 聯合王國註冊日期 United Kingdom registration date

[17] 註冊有效期屆滿日期 Expiry date of the period of registration

[22] 提交日期 Filing date / 當作提交日期 Deemed filing date / 聯合王國提交日期 United Kingdom filing date

[30] 聲稱享有的優先權（提交日期 / 巴黎公約國或世界貿易組織成員 / 申請編號） Priority claimed (filing date / Paris Convention country or WTO member / application number)

[51] 國際外觀設計分類號（洛迦諾分類號） International Classification of designs (Locarno Classification)

[54] 物品 Article

[55] 外觀設計的表述 Representation of the design

[62] 分開前的申請編號及提交日期 Application number before division and filing date

[66] 過往註冊的聯繫外觀設計註冊編號 / 日期 Registration No. / Date of Previous Registration for Association

[72] 設計人 Designer

[73] 擁有人姓名和地址 Name and address of the owner

[74] 代理人 Agent /送達地址 Address for service



香港特別行政區政府知識產權署外觀設計註冊處
The Government of the Hong Kong Special Administrative Region
Designs Registry, Intellectual Property Department

根據註冊外觀設計條例第 25 條註冊的外觀設計

Designs registered under section 25 of the Registered Designs Ordinance

按註冊編號排列

Arranged by Registration Number

[11] 2321845.4M001

[15] 08-08-2023

[30] 09-02-2023 / JP / 002432 of 2023

[51] Cl. 6-13

[54] 床墊罩

Mattress cover

[73] AIRWEAVE INC.

28, Aza-Arai, Oaza-Ogi, Kota-cho,

Nukata-gun, Aichi 4440115,

Japan

[74] CHINA PATENT AGENT (HONG KONG) LIMITED

22/F, Great Eagle Centre,

23 Harbour Road,

Wanchai, Hong Kong

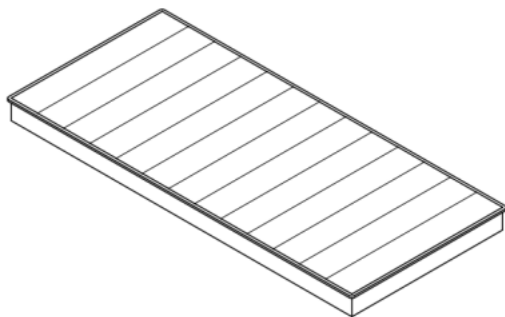

[11] 2321845.4M002

[15] 08-08-2023

[30] 09-02-2023 / JP / 002433 of 2023

[51] Cl. 6-13

[54] 床墊內罩

Inner cover for a mattress

[73] AIRWEAVE INC.
28, Aza-Arai, Oaza-Ogi, Kota-cho,
Nukata-gun, Aichi 4440115,
Japan

[74] CHINA PATENT AGENT (HONG KONG) LIMITED
22/F, Great Eagle Centre,
23 Harbour Road,
Wanchai, Hong Kong

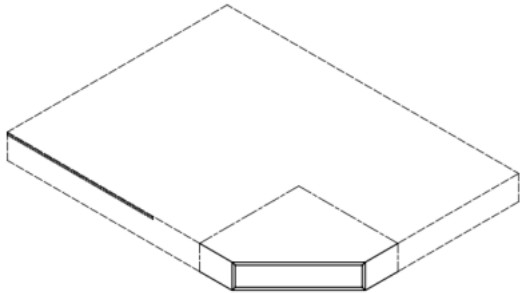

[11] 2321845.4M003

[15] 08-08-2023

[30] 09-02-2023 / JP / 002434 of 2023

[51] Cl. 6-13

[54] 床墊內罩

Inner cover for a mattress

[73] AIRWEAVE INC.
28, Aza-Arai, Oaza-Ogi, Kota-cho,
Nukata-gun, Aichi 4440115,
Japan

[74] CHINA PATENT AGENT (HONG KONG) LIMITED
22/F, Great Eagle Centre,
23 Harbour Road,
Wanchai, Hong Kong

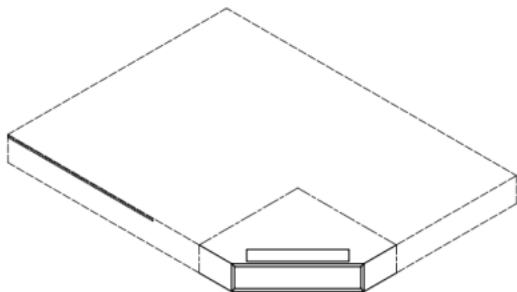

[11] 2322158.7

[15] 30-09-2023

[30] 31-03-2023 / FR / 20231530

[51] Cl. 11-01

[54] 首飾

Jewellery

[73] LOUIS VUITTON MALLETIER

2 rue du Pont-Neuf,

75001 Paris,

France

[74] BAKER & MCKENZIE

14th Floor, One Taikoo Place,

979 King's Road,

Quarry Bay, Hong Kong



[11] 2322159.9

[15] 30-09-2023

[30] 31-03-2023 / FR / 20231530

[51] Cl. 11-01

[54] 首飾

Jewellery

[73] LOUIS VUITTON MALLETIER

2 rue du Pont-Neuf,

75001 Paris,

France

[74] BAKER & MCKENZIE

14th Floor, One Taikoo Place,

979 King's Road,

Quarry Bay, Hong Kong



[11] 2322160.1

[15] 30-09-2023

[30] 31-03-2023 / FR / 20231533

[51] Cl. 11-01

[54] 首飾

Jewellery

[73] LOUIS VUITTON MALLETIER

2 rue du Pont-Neuf,

75001 Paris,

France

[74] BAKER & MCKENZIE

14th Floor, One Taikoo Place,

979 King's Road,

Quarry Bay, Hong Kong



- [11] 2322162.5
[15] 30-09-2023
[30] 02-04-2023 / FR / 20231550
[51] Cl. 11-01
[54] 首飾
Jewellery
[73] LOUIS VUITTON MALLETIER
2 rue du Pont-Neuf,
75001 Paris,
France
[74] BAKER & MCKENZIE
14th Floor, One Taikoo Place,
979 King's Road,
Quarry Bay, Hong Kong



-
- [11] 2322554.7
[15] 14-12-2023
[30] 03-07-2023 / NO, SG, CH, GB, EU / DM/230 815
[51] Cl. 7-02
[54] 煮咖啡器
Coffee maker
[73] Pi-Design AG
Altgasse 82,
CH-6340 Baar,
Switzerland
[74] WENPING PATENT & TRADE MARK AGENT LIMITED
1701 Tung Wai Commercial Building,
111 Gloucester Road,
Hong Kong



[11] 2322584.0M001

[15] 21-12-2023

[51] Cl. 10-02

[54] 錶

Watch

[73] MONTRES BREGUET SA (MONTRES BREGUET AG) (MONTRES BREGUET LTD)

Place de la Tour 23,

1344 L'Abbaye,

Switzerland

[74] SPRUSON & FERGUSON (HONG KONG) LIMITED

5001 Hopewell Centre,

183 Queen's Road East,

Wan Chai, Hong Kong



[11] 2322584.0M002

[15] 21-12-2023

[51] Cl. 10-02

[54] 錶

Watch

[73] MONTRES BREGUET SA (MONTRES BREGUET AG) (MONTRES BREGUET LTD)
Place de la Tour 23,
1344 L'Abbaye,
Switzerland

[74] SPRUSON & FERGUSON (HONG KONG) LIMITED
5001 Hopewell Centre,
183 Queen's Road East,
Wan Chai, Hong Kong



[11] 2322584.0M003

[15] 21-12-2023

[51] Cl. 10-02

[54] 錶

Watch

[73] MONTRES BREGUET SA (MONTRES BREGUET AG) (MONTRES BREGUET LTD)
Place de la Tour 23,
1344 L'Abbaye,
Switzerland

[74] SPRUSON & FERGUSON (HONG KONG) LIMITED
5001 Hopewell Centre,
183 Queen's Road East,
Wan Chai, Hong Kong



- [11] 2422706.2
[15] 18-01-2024
[51] Cl. 3-01
[54] 磁吸保護殼
Protective case with magnetic
[73] 創新產品有限公司
INNOVATION PRODUCTS LIMITED
Flat/Rm 1903, 19/F, Elite Centre,
22 Hung To Road,
Kwun Tong, Kowloon, Hong Kong
[74] INNOVATION PRODUCTS LIMITED (創新產品有限公司)
Flat/Rm 1903, 19/F, Elite Centre,
22 Hung To Road,
Kwun Tong, Kowloon, Hong Kong



-
- [11] 2422716.3
[15] 19-01-2024
[30] 12-12-2023 / TW / 112306507
[51] Cl. 9-05
[54] 泡殼
Blister pack
[73] 相信音樂國際股份有限公司
B'IN MUSIC INTERNATIONAL LIMITED
6F., No. 12, Ln. 33, Guangfu S. Rd.,
Songshan Dist., Taipei City 10563,
Taiwan
[74] MARKS & CLERK
Level 9, Cyberport 1,
100 Cyberport Road,
Pok Fu Lam, Hong Kong



[11] 2422717.5

[15] 19-01-2024

[30] 12-12-2023 / TW / 112306506

[51] Cl. 9-05

[54] 泡殼

Blister pack

[73] 相信音樂國際股份有限公司

B' IN MUSIC INTERNATIONAL LIMITED
6F., No. 12, Ln. 33, Guangfu S. Rd.,
Songshan Dist., Taipei City 10563,
Taiwan

[74] MARKS & CLERK

Level 9, Cyberport 1,
100 Cyberport Road,
Pok Fu Lam, Hong Kong



[11] 2422731.4

- [15] 24-01-2024
- [51] Cl. 20-03
- [54] 速熱淨水廣告機
Quick-heating water-purifying advertise machine
- [73] 韓文正
Wenzheng Han
中國深圳市龍崗區
南灣街道南嶺村社區
金坑北路 7 號金龍花園 B 棟 108
- [74] 千里馬知識產權有限公司
香港九龍旺角
花園街 2-16 號
好景商業中心 16 樓 4 室



-
- [11] 2422744.1
- [15] 25-01-2024
- [30] 11-12-2023 / TW / 112306474
- [51] Cl. 3-01
- [54] 袋
Bag
- [73] 相信音樂國際股份有限公司
B' IN MUSIC INTERNATIONAL LIMITED
6F., No. 12, Ln. 33,
Guangfu S. Rd., Songshan Dist.,
Taipei City 10563, Taiwan
- [74] MARKS & CLERK
Level 9, Cyberport 1,
100 Cyberport Road,
Pok Fu Lam, Hong Kong

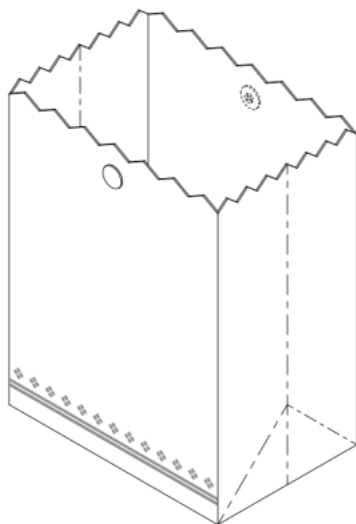

[11] 2422745.4

[15] 25-01-2024

[30] 11-12-2023 / TW / 112306475

[51] Cl. 20-02

[54] 支架插片

Stand panel

[73] 相信音樂國際股份有限公司

B'IN MUSIC INTERNATIONAL LIMITED

6F., No. 12, Ln. 33,

Guangfu S. Rd., Songshan Dist.,

Taipei City 10563, Taiwan

[74] MARKS & CLERK

Level 9, Cyberport 1,

100 Cyberport Road,

Pok Fu Lam, Hong Kong



- [11] 2422860.7
[15] 29-02-2024
[30] 04-09-2023 / CH / 147571
[51] Cl. 20-02
[54] 櫃檯
Counter
[73] Société des Produits Nestlé S.A.
1800 Vevey,
Switzerland
[74] DEACONS
5th Floor, Alexandra House,
Central,
Hong Kong

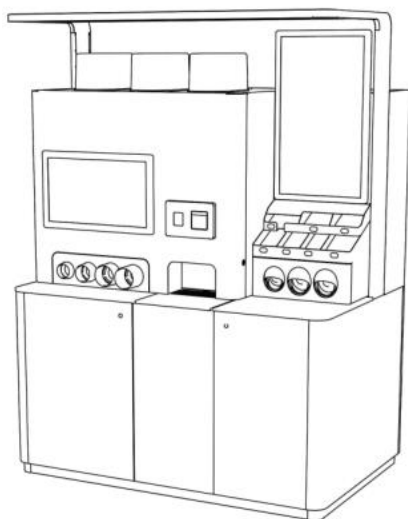

-
- [11] 2422881.1
[15] 04-03-2024
[30] 19-09-2023 / KR / 30-2023-0037078
[51] Cl. 23-04
[54] 空氣清新機
Air purifier
[73] LG Jeon za Joo-sik-hoi-sa (LG Electronics Inc.)
128, Yeoui-daero,
Yeongdeungpo-gu, Seoul, 07336,
Republic of Korea
[74] SPRUSON & FERGUSON (HONG KONG) LIMITED
5001 Hopewell Centre,
183 Queen's Road East,
Wan Chai, Hong Kong

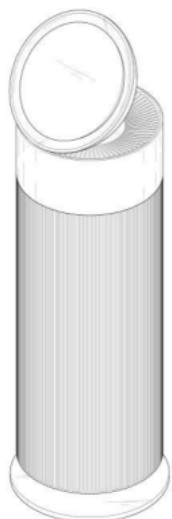

[11] 2422890.0

[15] 05-03-2024

[51] Cl. 11-01

[54] 鏈子鎖扣
Chain clasp

[73] 深圳市華悅珠寶科技有限公司
中國深圳市鹽田區
沙頭角街道田心社區深鹽路 3051 號
龍嘉首飾一棟 2 層及 3 層 302 房

[74] 天標知識產權代理有限公司
香港九龍尖沙咀
加連威老道 14 號
加連威大廈 4 樓 A 座



- [11] 2422891.2
[15] 05-03-2024
[51] Cl. 11-01
[54] 鏈子鎖扣
Chain clasp
[73] 深圳市華悅珠寶科技有限公司
中國深圳市鹽田區
沙頭角街道田心社區深鹽路 3051 號
龍嘉首飾一棟 2 層及 3 層 302 房
[74] 天標知識產權代理有限公司
香港九龍尖沙咀
加連威老道 14 號
加連威大廈 4 樓 A 座



-
- [11] 2422895.1
[15] 06-03-2024
[51] Cl. 11-01
[54] 手鏈
Bracelet
[73] 滿福珠寶金行有限公司
Moon Fook Jewellery (Hong Kong) Limited
香港尖沙咀
國都大廈
804 室
[74] 卓遠知識產權有限公司
香港上環
禧利街 27 號
富輝商業中心 10 樓



[11] 2422897.5

[15] 06-03-2024

[51] Cl. 2-03

[54] 防水純綿布料浴帽

Water proof cotton cloth shower cap

[73] 遠東酒店用品有限公司

Far East Hotel Supplies Company Limited

香港新蒲崗

大有街 32 號

泰力工業中心 7 樓 13 室

[74] 遠東酒店用品有限公司

香港新蒲崗

大有街 32 號

泰力工業中心 7 樓 13 室

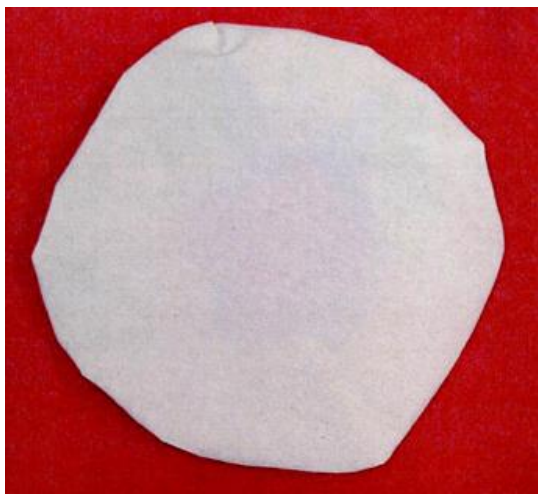

[11] 2422908.0

[15] 07-03-2024

[30] 23-10-2023 / KR / 30-2023-0041419

[51] Cl. 28-03

[54] 化妝品容器

Cosmetic container

[73] INNISFREE CORPORATION

100, Hangang-daero,

Yongsan-gu, Seoul,
Republic of Korea

[74] TRADEMARKCN COMPANY LIMITED
Block A, 4/F., Granville Building,
14 Granville Road,
Tsim Sha Tsui, Kowloon, Hong Kong



[11] 2422910.4

[15] 07-03-2024

[30] 23-10-2023 / KR / 30-2023-0041420

[51] Cl. 28-03

[54] 分配器

Dispenser

[73] INNISFREE CORPORATION

100, Hangang-daero,
Yongsan-gu, Seoul,
Republic of Korea

[74] TRADEMARKCN COMPANY LIMITED

Block A, 4/F., Granville Building,
14 Granville Road,
Tsim Sha Tsui, Kowloon, Hong Kong



[11] 2422911.6

[15] 07-03-2024

[51] Cl. 11-01

[54] 戒指
Ring

[73] Liu Ka Wan Karen
Room A, 17/F, Man Hing Commercial Building,
79-83 Queen's Road Central,
Hong Kong

[74] TRADEMARKCN COMPANY LIMITED
Block A, 4/F., Granville Building,
14 Granville Road,
Tsim Sha Tsui, Kowloon, Hong Kong

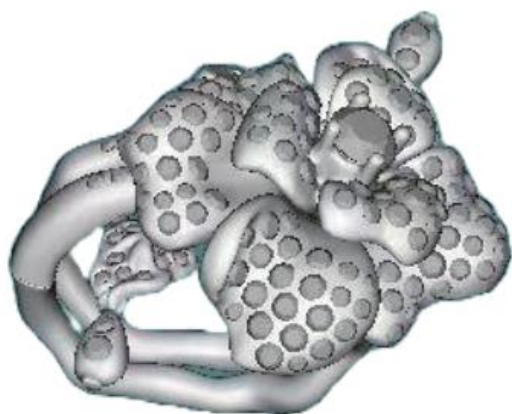

[11] 2422912.8

[15] 07-03-2024

[51] Cl. 11-01

[54] 戒指
Ring

[73] Liu Ka Wan Karen
Room A, 17/F, Man Hing Commercial Building,
79-83 Queen's Road Central,
Hong Kong

[74] TRADEMARKCN COMPANY LIMITED
Block A, 4/F., Granville Building,
14 Granville Road,
Tsim Sha Tsui, Kowloon, Hong Kong



[11] 2422913.0

[15] 07-03-2024

[51] Cl. 23-01

[54] 灑水器
Water sprinkler

[73] 客來博股份公司
CLABER S.p.A.
Via Pontebbana, 22,
33080 Fiume Veneto,
Pordenone, Italy

[74] UNITALEN ATTORNEYS AT LAW LIMITED
Room 1201, 12/F, Golden Era Plaza,
39-55 Sai Yee Street,
Mongkok, Kowloon, Hong Kong



[11] 2422914.2M001

[15] 07-03-2024

[51] Cl. 11-01

[54] 珠寶飾品

Jewellery ornament

[73] 周大福珠寶金行(深圳)有限公司

CHOW TAI FOOK JEWELLERY (SHENZHEN) CO., LTD.

中國廣東省

深圳市鹽田區深鹽路

黃金珠寶大廈 12 樓 A 座

[74] 中一聯合國際知識產權有限公司

香港九龍尖沙咀

漆咸道南 45-51 號

其士大廈 803 室



[11] 2422914.2M002

[15] 07-03-2024

[51] Cl. 11-01

[54] 珠寶飾品
Jewellery ornament

[73] 周大福珠寶金行(深圳)有限公司
CHOW TAI FOOK JEWELLERY (SHENZHEN) CO., LTD.
中國廣東省
深圳市鹽田區深鹽路
黃金珠寶大廈 12 樓 A 座

[74] 中一聯合國際知識產權有限公司
香港九龍尖沙咀
漆咸道南 45-51 號
其士大廈 803 室



[11] 2422914.2M003

[15] 07-03-2024

[51] Cl. 11-01

[54] 珠寶飾品
Jewellery ornament

[73] 周大福珠寶金行(深圳)有限公司
CHOW TAI FOOK JEWELLERY (SHENZHEN) CO., LTD.
中國廣東省
深圳市鹽田區深鹽路
黃金珠寶大廈 12 樓 A 座

[74] 中一聯合國際知識產權有限公司
香港九龍尖沙咀
漆咸道南 45-51 號
其士大廈 803 室



[11] 2422914.2M004

[15] 07-03-2024

[51] Cl. 11-01

[54] 珠寶飾品

Jewellery ornament

[73] 周大福珠寶金行(深圳)有限公司

CHOW TAI FOOK JEWELLERY (SHENZHEN) CO., LTD.

中國廣東省

深圳市鹽田區深鹽路

黃金珠寶大廈 12 樓 A 座

[74] 中一聯合國際知識產權有限公司

香港九龍尖沙咀

漆咸道南 45-51 號

其士大廈 803 室



[11] 2422914.2M005

[15] 07-03-2024

[51] Cl. 11-01

- [54] 珠寶飾品
Jewellery ornament
- [73] 周大福珠寶金行(深圳)有限公司
CHOW TAI FOOK JEWELLERY (SHENZHEN) CO., LTD.
中國廣東省
深圳市鹽田區深鹽路
黃金珠寶大廈 12 樓 A 座
- [74] 中一聯合國際知識產權有限公司
香港九龍尖沙咀
漆咸道南 45-51 號
其士大廈 803 室



-
- [11] 2422914.2M006
- [15] 07-03-2024
- [51] Cl. 11-01
- [54] 珠寶飾品
Jewellery ornament
- [73] 周大福珠寶金行(深圳)有限公司
CHOW TAI FOOK JEWELLERY (SHENZHEN) CO., LTD.
中國廣東省
深圳市鹽田區深鹽路
黃金珠寶大廈 12 樓 A 座
- [74] 中一聯合國際知識產權有限公司
香港九龍尖沙咀
漆咸道南 45-51 號
其士大廈 803 室



[11] 2422914.2M007

[15] 07-03-2024

[51] Cl. 11-01

[54] 珠寶飾品

Jewellery ornament

[73] 周大福珠寶金行(深圳)有限公司

CHOW TAI FOOK JEWELLERY (SHENZHEN) CO., LTD.

中國廣東省

深圳市鹽田區深鹽路

黃金珠寶大廈 12 樓 A 座

[74] 中一聯合國際知識產權有限公司

香港九龍尖沙咀

漆咸道南 45-51 號

其士大廈 803 室



[11] 2422914.2M008

[15] 07-03-2024

[51] Cl. 11-01

[54] 珠寶飾品

Jewellery ornament

[73] 周大福珠寶金行(深圳)有限公司

CHOW TAI FOOK JEWELLERY (SHENZHEN) CO., LTD.

中國廣東省
深圳市鹽田區深鹽路
黃金珠寶大廈 12 樓 A 座

- [74] 中一聯合國際知識產權有限公司
香港九龍尖沙咀
漆咸道南 45-51 號
其士大廈 803 室



-
- [11] 2422915.5
[15] 07-03-2024
[30] 17-01-2024 / CN / 202430030385.0
[51] Cl. 2-02
[54] 西裝上衣
Suit
[73] 上海麗致服裝有限公司
Tie ForHer Co., Limited
中國上海市
崇明區新河鎮
新開河路 825 號
[74] 港智國際知識產權代理有限公司
香港屯門
震寰路 3 號
德榮工業大廈 21 字樓 B11 室



[11] 2422921.7

[15] 08-03-2024

[30] 27-09-2023 / CN / 2023306344794

[51] C1. 15-05

[54] 烘衣機

Clothes dryer

[73] 林曉偉

中國廣東省

揭陽市空港經濟區

鳳美東升村一圍七巷 68 號，郵編：522000

[74] 卓遠知識產權有限公司

香港上環

禧利街 27 號

富輝商業中心 10 樓



[11] 2422925.6

[15] 11-03-2024

[51] Cl. 7-02

[54] 電煎鍋

Electric skillet

[73] ZOJIRUSHI CORPORATION

20-5, 1-Chome, Tenma,
Kita-ku, Osaka, 530-8511,
Japan

[74] HASTINGS & CO

5/F, Gloucester Tower, The Landmark,
11 Pedder Street,
Central, Hong Kong



[11] 2422928.2M001

[15] 11-03-2024

[30] 23-11-2023 / EU / 015042004-0001

[51] Cl. 26-06

[54] 汽車頭燈

Front lights for vehicles

[73] Dr. Ing. h.c. F. Porsche Aktiengesellschaft

Porscheplatz 1,
70435 Stuttgart,
Germany

[74] WENPING PATENT & TRADE MARK AGENT LIMITED

1701 Tung Wai Commercial Building,
111 Gloucester Road,
Hong Kong



[11] 2422928.2M002

[15] 11-03-2024

[30] 23-11-2023 / EU / 015042004-0002

[51] Cl. 26-06

[54] 汽車頭燈

Front lights for vehicles

[73] Dr. Ing. h.c. F. Porsche Aktiengesellschaft

Porscheplatz 1,

70435 Stuttgart,

Germany

[74] WENPING PATENT & TRADE MARK AGENT LIMITED

1701 Tung Wai Commercial Building,

111 Gloucester Road,

Hong Kong



[11] 2422928.2M003

[15] 11-03-2024

[30] 23-11-2023 / EU / 015042004-0003

[51] Cl. 26-06

[54] 汽車頭燈

Front lights for vehicles

[73] Dr. Ing. h.c. F. Porsche Aktiengesellschaft

Porscheplatz 1,

70435 Stuttgart,
Germany

[74] WENPING PATENT & TRADE MARK AGENT LIMITED
1701 Tung Wai Commercial Building,
111 Gloucester Road,
Hong Kong



[11] 2422928.2M004

[15] 11-03-2024

[30] 23-11-2023 / EU / 015042004-0004

[51] Cl. 26-06

[54] 汽車頭燈

Front lights for vehicles

[73] Dr. Ing. h.c. F. Porsche Aktiengesellschaft
Porscheplatz 1,
70435 Stuttgart,
Germany

[74] WENPING PATENT & TRADE MARK AGENT LIMITED
1701 Tung Wai Commercial Building,
111 Gloucester Road,
Hong Kong



[11] 2422928.2M005

[15] 11-03-2024

[30] 23-11-2023 / EU / 015042004-0005

[51] Cl. 26-06

[54] 汽車頭燈

Front lights for vehicles

[73] Dr. Ing. h.c. F. Porsche Aktiengesellschaft

Porscheplatz 1,

70435 Stuttgart,

Germany

[74] WENPING PATENT & TRADE MARK AGENT LIMITED

1701 Tung Wai Commercial Building,

111 Gloucester Road,

Hong Kong



[11] 2422928.2M006

[15] 11-03-2024

[30] 23-11-2023 / EU / 015042004-0006

[51] Cl. 26-06

[54] 汽車頭燈

Front lights for vehicles

[73] Dr. Ing. h.c. F. Porsche Aktiengesellschaft

Porscheplatz 1,

70435 Stuttgart,

Germany

[74] WENPING PATENT & TRADE MARK AGENT LIMITED

1701 Tung Wai Commercial Building,

111 Gloucester Road,

Hong Kong



[11] 2422928.2M007

[15] 11-03-2024

[30] 23-11-2023 / EU / 015042004-0007

[51] Cl. 26-06

[54] 汽車頭燈

Front lights for vehicles

[73] Dr. Ing. h.c. F. Porsche Aktiengesellschaft

Porscheplatz 1,

70435 Stuttgart,

Germany

[74] WENPING PATENT & TRADE MARK AGENT LIMITED

1701 Tung Wai Commercial Building,

111 Gloucester Road,

Hong Kong



[11] 2422928.2M008

[15] 11-03-2024

[30] 23-11-2023 / EU / 015042004-0008

[51] Cl. 26-06

[54] 汽車頭燈

Front lights for vehicles

[73] Dr. Ing. h.c. F. Porsche Aktiengesellschaft

Porscheplatz 1,

70435 Stuttgart,

Germany

[74] WENPING PATENT & TRADE MARK AGENT LIMITED

1701 Tung Wai Commercial Building,

111 Gloucester Road,

Hong Kong



[11] 2422928.2M009

[15] 11-03-2024

[30] 23-11-2023 / EU / 015042004-0009

[51] Cl. 26-06

[54] 汽車頭燈

Front lights for vehicles

[73] Dr. Ing. h.c. F. Porsche Aktiengesellschaft

Porscheplatz 1,

70435 Stuttgart,

Germany

[74] WENPING PATENT & TRADE MARK AGENT LIMITED

1701 Tung Wai Commercial Building,

111 Gloucester Road,

Hong Kong



[11] 2422928.2M010

[15] 11-03-2024

[30] 23-11-2023 / EU / 015042004-0010

[51] Cl. 26-06

[54] 汽車頭燈

Front lights for vehicles

[73] Dr. Ing. h.c. F. Porsche Aktiengesellschaft

Porscheplatz 1,

70435 Stuttgart,
Germany

[74] WENPING PATENT & TRADE MARK AGENT LIMITED
1701 Tung Wai Commercial Building,
111 Gloucester Road,
Hong Kong



[11] 2422928.2M011

[15] 11-03-2024

[30] 23-11-2023 / EU / 015042004-0011

[51] Cl. 26-06

[54] 汽車頭燈

Front lights for vehicles

[73] Dr. Ing. h.c. F. Porsche Aktiengesellschaft
Porscheplatz 1,
70435 Stuttgart,
Germany

[74] WENPING PATENT & TRADE MARK AGENT LIMITED
1701 Tung Wai Commercial Building,
111 Gloucester Road,
Hong Kong



[11] 2422928.2M012

[15] 11-03-2024

[30] 23-11-2023 / EU / 015042004-0012

[51] Cl. 26-06

[54] 汽車頭燈

Front lights for vehicles

[73] Dr. Ing. h.c. F. Porsche Aktiengesellschaft

Porscheplatz 1,

70435 Stuttgart,

Germany

[74] WENPING PATENT & TRADE MARK AGENT LIMITED

1701 Tung Wai Commercial Building,

111 Gloucester Road,

Hong Kong



[11] 2422928.2M013

[15] 11-03-2024

[30] 23-11-2023 / EU / 015042004-0013

[51] Cl. 26-06

[54] 汽車頭燈

Front lights for vehicles

[73] Dr. Ing. h.c. F. Porsche Aktiengesellschaft

Porscheplatz 1,

70435 Stuttgart,

Germany

[74] WENPING PATENT & TRADE MARK AGENT LIMITED

1701 Tung Wai Commercial Building,

111 Gloucester Road,

Hong Kong



[11] 2422928.2M014

[15] 11-03-2024

[30] 23-11-2023 / EU / 015042004-0014

[51] Cl. 26-06

[54] 汽車頭燈

Front lights for vehicles

[73] Dr. Ing. h.c. F. Porsche Aktiengesellschaft

Porscheplatz 1,

70435 Stuttgart,

Germany

[74] WENPING PATENT & TRADE MARK AGENT LIMITED

1701 Tung Wai Commercial Building,

111 Gloucester Road,

Hong Kong



[11] 2422928.2M015

[15] 11-03-2024

[30] 23-11-2023 / EU / 015042004-0015

[51] Cl. 26-06

[54] 汽車尾燈

Rear lights for vehicles

[73] Dr. Ing. h.c. F. Porsche Aktiengesellschaft

Porscheplatz 1,

70435 Stuttgart,
Germany

[74] WENPING PATENT & TRADE MARK AGENT LIMITED
1701 Tung Wai Commercial Building,
111 Gloucester Road,
Hong Kong



[11] 2422928.2M016

[15] 11-03-2024

[30] 23-11-2023 / EU / 015042004-0016

[51] Cl. 26-06

[54] 汽車尾燈

Rear lights for vehicles

[73] Dr. Ing. h.c. F. Porsche Aktiengesellschaft
Porscheplatz 1,
70435 Stuttgart,
Germany

[74] WENPING PATENT & TRADE MARK AGENT LIMITED
1701 Tung Wai Commercial Building,
111 Gloucester Road,
Hong Kong



[11] 2422928.2M017

[15] 11-03-2024

[30] 23-11-2023 / EU / 015042004-0017

[51] Cl. 26-06

[54] 汽車尾燈

Rear lights for vehicles

[73] Dr. Ing. h.c. F. Porsche Aktiengesellschaft

Porscheplatz 1,
70435 Stuttgart,
Germany

[74] WENPING PATENT & TRADE MARK AGENT LIMITED

1701 Tung Wai Commercial Building,
111 Gloucester Road,
Hong Kong



[11] 2422928.2M018

[15] 11-03-2024

[30] 23-11-2023 / EU / 015042004-0018

[51] Cl. 26-06

[54] 汽車尾燈

Rear lights for vehicles

[73] Dr. Ing. h.c. F. Porsche Aktiengesellschaft

Porscheplatz 1,
70435 Stuttgart,
Germany

[74] WENPING PATENT & TRADE MARK AGENT LIMITED

1701 Tung Wai Commercial Building,
111 Gloucester Road,
Hong Kong

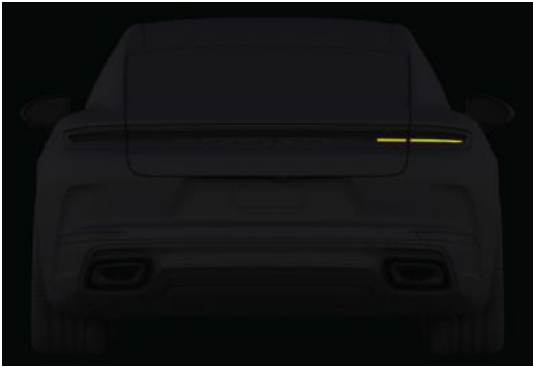

[11] 2422928.2M019

[15] 11-03-2024

[30] 23-11-2023 / EU / 015042004-0019

[51] Cl. 26-06

[54] 汽車尾燈

Rear lights for vehicles

[73] Dr. Ing. h.c. F. Porsche Aktiengesellschaft
Porscheplatz 1,
70435 Stuttgart,
Germany

[74] WENPING PATENT & TRADE MARK AGENT LIMITED
1701 Tung Wai Commercial Building,
111 Gloucester Road,
Hong Kong



[11] 2422928.2M020

[15] 11-03-2024

[30] 23-11-2023 / EU / 015042004-0020

[51] Cl. 26-06

[54] 汽車尾燈

Rear lights for vehicles

[73] Dr. Ing. h.c. F. Porsche Aktiengesellschaft
Porscheplatz 1,

70435 Stuttgart,
Germany

[74] WENPING PATENT & TRADE MARK AGENT LIMITED
1701 Tung Wai Commercial Building,
111 Gloucester Road,
Hong Kong



[11] 2422928.2M021

[15] 11-03-2024

[30] 23-11-2023 / EU / 015042004-0021

[51] Cl. 26-06

[54] 汽車尾燈

Rear lights for vehicles

[73] Dr. Ing. h.c. F. Porsche Aktiengesellschaft
Porscheplatz 1,
70435 Stuttgart,
Germany

[74] WENPING PATENT & TRADE MARK AGENT LIMITED
1701 Tung Wai Commercial Building,
111 Gloucester Road,
Hong Kong



[11] 2422928.2M022

- [15] 11-03-2024
- [30] 23-11-2023 / EU / 015042004-0022
- [51] Cl. 26-06
- [54] 汽車尾燈
Rear lights for vehicles
- [73] Dr. Ing. h.c. F. Porsche Aktiengesellschaft
Porscheplatz 1,
70435 Stuttgart,
Germany
- [74] WENPING PATENT & TRADE MARK AGENT LIMITED
1701 Tung Wai Commercial Building,
111 Gloucester Road,
Hong Kong



-
- [11] 2422928.2M023
- [15] 11-03-2024
- [30] 23-11-2023 / EU / 015042004-0023
- [51] Cl. 26-06
- [54] 汽車尾燈
Rear lights for vehicles
- [73] Dr. Ing. h.c. F. Porsche Aktiengesellschaft
Porscheplatz 1,
70435 Stuttgart,
Germany
- [74] WENPING PATENT & TRADE MARK AGENT LIMITED
1701 Tung Wai Commercial Building,
111 Gloucester Road,
Hong Kong



[11] 2422928.2M024

[15] 11-03-2024

[30] 23-11-2023 / EU / 015042004-0024

[51] Cl. 26-06

[54] 汽車尾燈

Rear lights for vehicles

[73] Dr. Ing. h.c. F. Porsche Aktiengesellschaft

Porscheplatz 1,

70435 Stuttgart,

Germany

[74] WENPING PATENT & TRADE MARK AGENT LIMITED

1701 Tung Wai Commercial Building,

111 Gloucester Road,

Hong Kong



[11] 2422928.2M025

[15] 11-03-2024

[30] 23-11-2023 / EU / 015042004-0025

[51] Cl. 26-06

[54] 汽車尾燈

Rear lights for vehicles

[73] Dr. Ing. h.c. F. Porsche Aktiengesellschaft

Porscheplatz 1,

70435 Stuttgart,
Germany

[74] WENPING PATENT & TRADE MARK AGENT LIMITED
1701 Tung Wai Commercial Building,
111 Gloucester Road,
Hong Kong



[11] 2422928.2M026

[15] 11-03-2024

[30] 23-11-2023 / EU / 015042004-0026

[51] Cl. 26-06

[54] 汽車尾燈

Rear lights for vehicles

[73] Dr. Ing. h.c. F. Porsche Aktiengesellschaft
Porscheplatz 1,
70435 Stuttgart,
Germany

[74] WENPING PATENT & TRADE MARK AGENT LIMITED
1701 Tung Wai Commercial Building,
111 Gloucester Road,
Hong Kong



[11] 2422928.2M027

[15] 11-03-2024

[30] 23-11-2023 / EU / 015042004-0027

[51] Cl. 26-06

[54] 汽車尾燈

Rear lights for vehicles

[73] Dr. Ing. h.c. F. Porsche Aktiengesellschaft

Porscheplatz 1,
70435 Stuttgart,
Germany

[74] WENPING PATENT & TRADE MARK AGENT LIMITED

1701 Tung Wai Commercial Building,
111 Gloucester Road,
Hong Kong



[11] 2422928.2M028

[15] 11-03-2024

[30] 23-11-2023 / EU / 015042004-0028

[51] Cl. 26-06

[54] 汽車尾燈

Rear lights for vehicles

[73] Dr. Ing. h.c. F. Porsche Aktiengesellschaft

Porscheplatz 1,
70435 Stuttgart,
Germany

[74] WENPING PATENT & TRADE MARK AGENT LIMITED

1701 Tung Wai Commercial Building,
111 Gloucester Road,
Hong Kong



[11] 2422928.2M029

[15] 11-03-2024

[30] 23-11-2023 / EU / 015042004-0029

[51] Cl. 26-06

[54] 汽車尾燈

Rear lights for vehicles

[73] Dr. Ing. h.c. F. Porsche Aktiengesellschaft

Porscheplatz 1,
70435 Stuttgart,
Germany

[74] WENPING PATENT & TRADE MARK AGENT LIMITED

1701 Tung Wai Commercial Building,
111 Gloucester Road,
Hong Kong



[11] 2422928.2M030

[15] 11-03-2024

[30] 23-11-2023 / EU / 015042004-0030

[51] Cl. 26-06

[54] 汽車尾燈

Rear lights for vehicles

[73] Dr. Ing. h.c. F. Porsche Aktiengesellschaft

Porscheplatz 1,

70435 Stuttgart,
Germany

[74] WENPING PATENT & TRADE MARK AGENT LIMITED
1701 Tung Wai Commercial Building,
111 Gloucester Road,
Hong Kong



[11] 2422928.2M031

[15] 11-03-2024

[30] 23-11-2023 / EU / 015042004-0031

[51] Cl. 26-06

[54] 汽車尾燈

Rear lights for vehicles

[73] Dr. Ing. h.c. F. Porsche Aktiengesellschaft
Porscheplatz 1,
70435 Stuttgart,
Germany

[74] WENPING PATENT & TRADE MARK AGENT LIMITED
1701 Tung Wai Commercial Building,
111 Gloucester Road,
Hong Kong



[11] 2422928.2M032

[15] 11-03-2024

[30] 23-11-2023 / EU / 015042004-0032

[51] Cl. 26-06

[54] 汽車尾燈

Rear lights for vehicles

[73] Dr. Ing. h.c. F. Porsche Aktiengesellschaft

Porscheplatz 1,

70435 Stuttgart,

Germany

[74] WENPING PATENT & TRADE MARK AGENT LIMITED

1701 Tung Wai Commercial Building,

111 Gloucester Road,

Hong Kong



[11] 2422940.7

[15] 13-03-2024

[51] Cl. 28-03

[54] 粉盒

Powder compact

[73] Shiseido Company, Limited

5-5, Ginza 7-chome, Chuo-ku,

Tokyo 104-0061,

Japan

[74] MARKS & CLERK

Level 9, Cyberport 1,

100 Cyberport Road,

Pok Fu Lam, Hong Kong

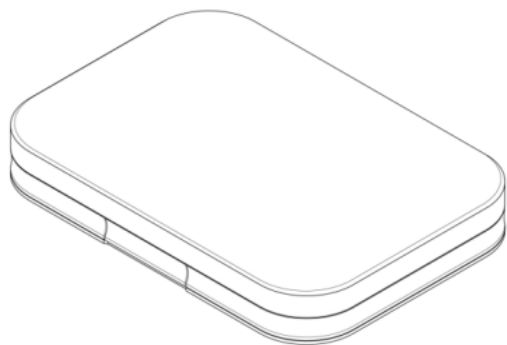

- [11] 2422941.9
[15] 13-03-2024
[51] Cl. 11-01
[54] 戒指
Ring
[73] Liu Ka Wan Karen
Room A, 17/F, Man Hing Commercial Building,
79-83 Queen's Road Central,
Hong Kong
[74] TRADEMARKCN COMPANY LIMITED
Block A, 4/F., Granville Building,
14 Granville Road,
Tsim Sha Tsui, Kowloon, Hong Kong

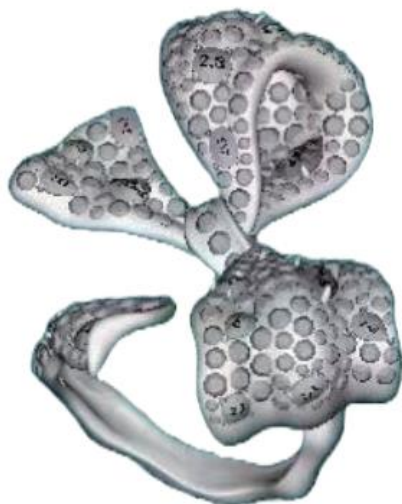

-
- [11] 2422942.1
[15] 13-03-2024
[51] Cl. 2-02
[54] 褲
Pants
[73] LAM CHIN NGAI
Rm 2218, Tsui Fuk House,
Tsui Wan Estate,
Chai Wan, Hong Kong
[74] ACCOLADE IP LIMITED
10/F, Fu Fai Comm. Ctr.,
27 Hillier Street,
Sheung Wan, Hong Kong



[11] 2422943.3

[15] 13-03-2024

[51] Cl. 6-04

[54] 雨傘除水器

Umbrella dryer

[73] 創新發展(香港)有限公司

Arte Espina (HK) Co., Ltd.

香港荃灣

柴灣角街 84-92 號

順豐工業大廈 17 樓 K 室

[74] 卓遠知識產權有限公司

香港上環

禧利街 27 號

富輝商業中心 10 樓



[11] 2422944.5

[15] 13-03-2024

[51] Cl. 28-03

[54] 用於隱形眼鏡和擴眼的工具

Tool used for contact lens and eye expansion

[73] 英泰行有限公司

CHINA FOCUS (HK) LIMITED

Flat 11, 17/F, Hewlett Centre,

52-54 Hoi Yuen Road,

Kwun Tong, Kowloon, Hong Kong

[74] ACCOLADE IP LIMITED

10/F, Fu Fai Comm. Ctr.,

27 Hillier Street,

Sheung Wan, Hong Kong



[11] 2422949.6M001

[15] 14-03-2024

[30] 21-12-2023 / EU / 015045256-0001

[51] Cl. 9-01

[54] 噴霧劑容器

Aerosol container

[73] DIPTYQUE S.A.S.

34, boulevard Saint Germain,

F-75005 Paris,

France

[74] ECCLES & LEE

Suite 3212, Jardine House,

1 Connaught Place,

Central, Hong Kong



[11] 2422949.6M002

[15] 14-03-2024

[30] 21-12-2023 / EU / 015045256-0002

[51] Cl. 9-01

[54] 噴霧劑容器 (的部分)

Aerosol container (part of-)

[73] DIPTYQUE S.A.S.

34, boulevard Saint Germain,

F-75005 Paris,

France

[74] ECCLES & LEE

Suite 3212, Jardine House,

1 Connaught Place,

Central, Hong Kong



- [11] 2422949.6M003
[15] 14-03-2024
[30] 21-12-2023 / EU / 015045256-0003
[51] Cl. 9-01
[54] 噴霧劑容器(的部分)
Aerosol container (part of-)
[73] DIPTYQUE S.A.S.
34, boulevard Saint Germain,
F-75005 Paris,
France
[74] ECCLES & LEE
Suite 3212, Jardine House,
1 Connaught Place,
Central, Hong Kong



-
- [11] 2422950.8M001
[15] 14-03-2024
[30] 21-12-2023 / EU / 015045258-0001
[51] Cl. 26-01
[54] 茶燭台
Tealight holder
[73] DIPTYQUE S.A.S.
34, boulevard Saint Germain,
F-75005 Paris,
France
[74] ECCLES & LEE
Suite 3212, Jardine House,
1 Connaught Place,
Central, Hong Kong



[11] 2422950.8M002

[15] 14-03-2024

[30] 21-12-2023 / EU / 015045258-0002

[51] Cl. 26-01

[54] 茶燭台

Tealight holder

[73] DIPTYQUE S.A.S.

34, boulevard Saint Germain,

F-75005 Paris,

France

[74] ECCLES & LEE

Suite 3212, Jardine House,

1 Connaught Place,

Central, Hong Kong

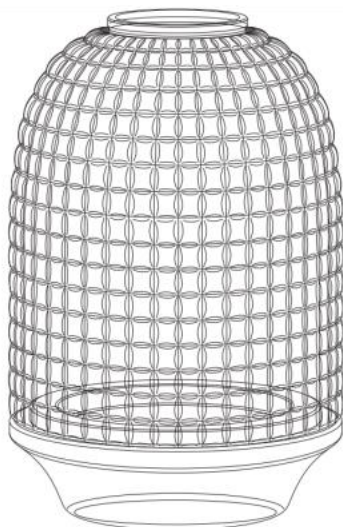

- [11] 2422951.0
[15] 14-03-2024
[30] 21-12-2023 / EU / 015045259-0001
[51] Cl. 26-01
[54] 茶燭台
Tealight holder
[73] DIPTYQUE S.A.S.
34, boulevard Saint Germain,
F-75005 Paris,
France
[74] ECCLES & LEE
Suite 3212, Jardine House,
1 Connaught Place,
Central, Hong Kong



-
- [11] 2422952.2
[15] 14-03-2024
[30] 21-12-2023 / EU / 015045262-0001
[51] Cl. 26-01
[54] 茶燭台
Tealight holder
[73] DIPTYQUE S.A.S.
34, boulevard Saint Germain,
F-75005 Paris,
France
[74] ECCLES & LEE
Suite 3212, Jardine House,
1 Connaught Place,
Central, Hong Kong



[11] 2422953.4M001

[15] 14-03-2024

[51] Cl. 19-08

[54] 包裝標籤

Packaging label

[73] 達江食品(香港)有限公司

Tat Kong Food (HK) Limited

香港元朗

喜業工廠大廈

4樓 T9-10 室

[74] 卓遠知識產權有限公司

香港上環

禧利街 27 號

富輝商業中心 10 樓



[11] 2422953.4M002

[15] 14-03-2024

[51] Cl. 19-08

- [54] 包裝標籤
Packaging label
- [73] 達江食品(香港)有限公司
Tat Kong Food (HK) Limited
香港元朗
喜業工廠大廈
4樓 T9-10 室
- [74] 卓遠知識產權有限公司
香港上環
禧利街 27 號
富輝商業中心 10 樓



-
- [11] 2422954.6M001
- [15] 14-03-2024
- [30] 21-12-2023 / EU / 015045263-0001
- [51] Cl. 26-01
- [54] 燭台
Candle holder
- [73] DIPTYQUE S.A.S.
34, boulevard Saint Germain,
F-75005 Paris,
France
- [74] ECCLES & LEE
Suite 3212, Jardine House,
1 Connaught Place,
Central, Hong Kong



[11] 2422954.6M002

[15] 14-03-2024

[30] 21-12-2023 / EU / 015045263-0002

[51] Cl. 26-01

[54] 燭台

Candle holder

[73] DIPTYQUE S.A.S.

34, boulevard Saint Germain,

F-75005 Paris,

France

[74] ECCLES & LEE

Suite 3212, Jardine House,

1 Connaught Place,

Central, Hong Kong

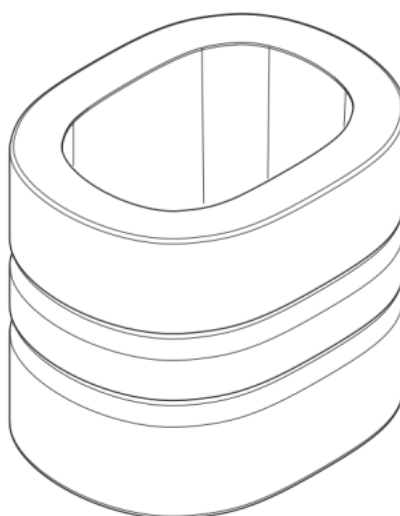

- [11] 2422954.6M003
[15] 14-03-2024
[30] 21-12-2023 / EU / 015045263-0003
[51] Cl. 26-01
[54] 燭台
Candle holder
[73] DIPTYQUE S.A.S.
34, boulevard Saint Germain,
F-75005 Paris,
France
[74] ECCLES & LEE
Suite 3212, Jardine House,
1 Connaught Place,
Central, Hong Kong

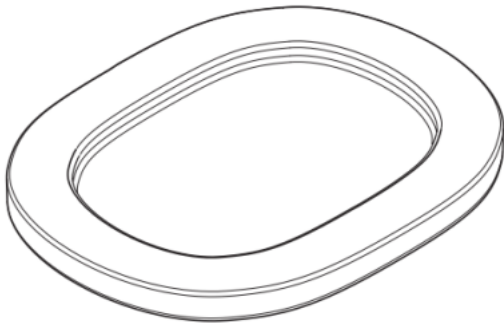

-
- [11] 2422957.3
[15] 14-03-2024
[30] 25-01-2024 / CN / 2024300510615
[51] Cl. 30-03
[54] 寵物飲水器
Pet water fountain
[73] 戴强
Qiang DAI
加拿大
汉密尔顿市
马尔街道 20 号
[74] LISHI INTELLECTUAL PROPERTY GROUP (INTERNATIONAL) LIMITED
香港九龍觀塘
興業街 15-17 號
中美中心 B 座 9 樓 9045 室



[11] 2422972.4

[15] 15-03-2024

[51] Cl. 11-01

[54] 圓形回力扣

Round spring ring

[73] 广州市天丰珠宝有限公司

Tin Fung Jewellery Limited (Guangzhou)

中國广东省

广州市番禺區沙頭街道

銀建路 34 號二樓

[74] LISHI INTELLECTUAL PROPERTY GROUP (INTERNATIONAL) LIMITED

香港九龍觀塘

興業街 15-17 號

中美中心 B 座 9 樓 9045 室

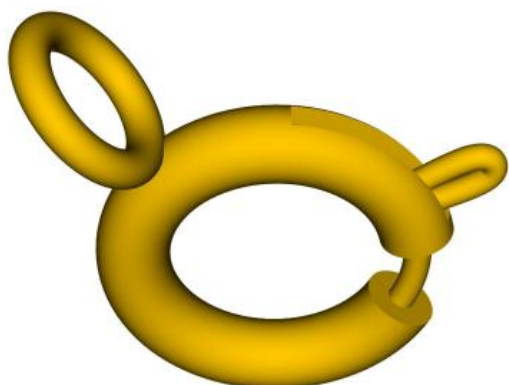

[11] 2422975.1M001

[15] 18-03-2024

[51] Cl. 28-03

[54] 吹風機

Hair drier

[73] 东莞港电电器制品有限公司

Dongguan Gangdian electrical Products Co., LTD

中國广东省

东莞市石排镇

工业大道 12 号

[74] 集佳知識產權有限公司

香港九龍

旺角太子道西 193 號

新世紀廣場一座 12 樓 1211 室



[11] 2422975.1M002

[15] 18-03-2024

[51] Cl. 28-03

[54] 吹風機

Hair drier

[73] 东莞港电电器制品有限公司

Dongguan Gangdian electrical Products Co., LTD

中國广东省

东莞市石排镇

工业大道 12 号

[74] 集佳知識產權有限公司

香港九龍

旺角太子道西 193 號

新世紀廣場一座 12 樓 1211 室

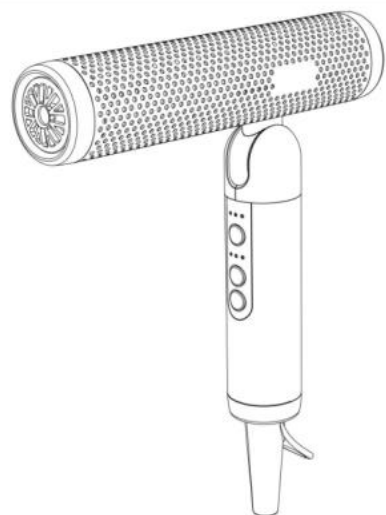



香港特別行政區政府知識產權署外觀設計註冊處

The Government of the Hong Kong Special Administrative Region

Designs Registry, Intellectual Property Department

根據註冊外觀設計條例第 28 條，下列註冊外觀設計因未繳續期費而停止有效。

各組記項按註冊外觀設計停止有效日期及註冊編號先後次序排列。

Registered designs ceased through non-payment of renewal fees under section 28 of the Registered Designs Ordinance. Entries are listed below under their expiry dates.

20-03-2024 - 27-03-2024

20-03-2024

1400523.5M001

1400523.5M002

1913257.0M001

1913257.0M002

1913257.0M003

1913257.0M004

1913257.0M005

1913258.2M002

1913258.2M007

1913258.2M008

1913258.2M009

1913258.2M010

1913258.2M015

1913259.4M001

1913259.4M002

1913261.8M001

1913261.8M002

1913261.8M003

1913262.0M001

1913262.0M002

1913262.0M003

1913263.2M001

1913263.2M002

1913263.2M003

1913264.4

1913267.1

21-03-2024

1400525.0

1913270.7

1913271.9M001

1913271.9M002

1913271.9M003

1913271.9M004

1913271.9M005

1913271.9M006

1913273.3

1913274.5

1913275.8

1913277.2

1913278.4

23-03-2024

0900462.7

0900463.9

1400527.4M001

1400527.4M002

1400529.8M001

24-03-2024

1400542.5

1913284.6M001

1913284.6M002

1913284.6M003

1913285.9M001

1913285.9M002

1913285.9M003

1913286.1

1913287.3

1913288.5

1913289.7

1913290.9

1913291.1

1913293.5

1913295.0

1913297.4

25-03-2024

0900476.7M002

1400553.8

1400557.7M001

1400557.7M002

1400560.3

1913301.4

1913303.8M001

1913303.8M002

1913303.8M003

1913304.0M001

1913304.0M002

1913304.0M003

1913305.3M001

1913305.3M002

1913306.5M001

1913306.5M002

1913306.5M003

1913306.5M004

1913306.5M008

1913306.5M009

1913306.5M010

1913306.5M011

1913306.5M012

26-03-2024

0410685.8

0411717.8

1400565.4

1400566.6M001

1400566.6M002

1400566.6M003

1913308.9M001

1913308.9M002

1913308.9M003
1913309.1
1913311.5
1913313.9M001
1913313.9M002
1913313.9M003
1913313.9M004
1913313.9M005
1913317.8
1913318.0M001
1913318.0M002

27-03-2024

1913321.6M001
1913321.6M002
1913321.6M003
1913322.8
1913325.5



香港特別行政區政府知識產權署外觀設計註冊處
The Government of the Hong Kong Special Administrative Region
Designs Registry, Intellectual Property Department

根據註冊外觀設計規則第 31 條刪除的註冊外觀設計。各組記項按註冊外觀設計刪除日期及註冊編號先後次序排列。

Registered designs removed under section 31 of the Registered Designs Rules. Entries are listed below under their removal dates.

28-03-2024 - 04-04-2024

28-03-2024	1301635.3	04-04-2024
1801933.9	1301639.1M002	1801974.5
1801934.1	1801950.5	1801976.0M002
1801939.2	1801951.7M002	1801976.0M004
1801940.4	1801951.7M003	1801976.0M005
1801941.6M001		1801978.4
1801941.6M002	01-04-2024	1801979.6
1801941.6M003	0802346.3	1801983.4
1801941.6M004	0802349.9	1801984.6M001
1801941.6M005	0802350.1	1801984.6M002
1801942.8M001	1301648.0	
1801942.8M002	1301650.4	
1801942.8M003		
	02-04-2024	
29-03-2024	0802354.9	
0802286.5M003	0802360.2	
1801946.7M001	0802362.6	
1801946.7M002	1301655.5	
1801946.7M003	1301658.1M001	
1801947.9	1801952.9M001	
1801948.1M001	1801952.9M002	
1801948.1M002	1801952.9M003	
	1801952.9M004	
	1801953.1	
30-03-2024		
0802289.1M001		
0802289.1M002	03-04-2024	
0802290.3	1301664.3M001	
0802320.8	1301664.3M002	
1301629.0M004	1301664.3M003	
	1301664.3M004	
	1301667.0M005	
31-03-2024	1301671.8	
0802334.7M001	1801965.7	
0802334.7M002		
0802334.7M003		



香港特別行政區政府知識產權署外觀設計註冊處

The Government of the Hong Kong Special Administrative Region

Designs Registry, Intellectual Property Department

根據註冊外觀設計條例第 76 條，更正已提交文件中的錯誤

Correction of errors in filed documents under section 76 of the Registered Designs Ordinance

下列在 26.01.2024 官方公報刊登的更正錯誤的請求已在 27.03.2024 獲准許

The following request for correction of error advertised in the official journal on 26.01.2024 was allowed on 27.03.2024

[21] 2322149.8

[71] 公牛集團股份有限公司

GONEO GROUP CO., LTD.