

# 香港知識產權公報

Hong Kong Intellectual Property Journal

2024年7月19日  
19 July 2024



## 目錄 Contents

### 根據註冊外觀設計條例第 25 條註冊的外觀設計

#### **Designs Registered under section 25 of the Registered Designs Ordinance**

按註冊編號排列

Arranged by Registration Number

### 根據註冊外觀設計條例(第 522 章)公布的其他公告

#### **Other Notices Published under the Registered Designs Ordinance (Cap. 522)**

根據註冊外觀設計條例第 28 條，註冊外觀設計因未繳續期費而停止有效

Registered designs ceased through non-payment of renewal fees under section 28 of the Registered Designs Ordinance

根據註冊外觀設計規則第 31 條刪除的註冊外觀設計

Registered designs removed under section 31 of the Registered Designs Rules

根據註冊外觀設計條例第 76 條，更正已提交文件中的錯誤

Correction of errors in filed documents under section 76 of the Registered Designs Ordinance

### 以下事項沒有記錄

#### **No Records for the Following Matters**

根據註冊外觀設計條例第 30 條放棄的外觀設計的註冊

Surrender of Registration of Design under section 30 of the Registered Designs Ordinance

根據註冊外觀設計規則第 37 條，向處長作出轉介

Reference to Registrar under section 37 of the Registered Designs Rules

根據註冊外觀設計條例第 45 條，撤銷註冊

Revocation of Registration under section 45 of the Registered Designs Ordinance

根據註冊外觀設計規則第 46 條，向法院作出轉介

Reference to Court under section 46 of the Registered Designs Rules

根據註冊外觀設計規則第 63 條對不符合規定之處作出糾正

Rectification of Irregularities under section 63 of the Registered Designs Rules

根據註冊外觀設計條例第 66 條，糾正註冊紀錄冊

Rectification of Register under section 66 of the Registered Designs Ordinance

根據註冊外觀設計條例第 67 條 更正註冊紀錄冊內的錯誤

Correction of errors in Register under section 67 of the Registered Designs Ordinance

根據註冊外觀設計條例第 67 及 76 條，更正註冊紀錄冊內及已提交文件中的錯誤

Correction of Errors in Register and in Filed Documents under sections 67 and 76 of the Registered Designs Ordinance

勘誤

Corrigendum

## 註冊外觀設計公告註釋

### Notes on advertisements of registration of designs

方括號表示下列資料：

Square brackets indicate the following data：

[11] 註冊編號 Registration number / 聯合王國註冊編號 United Kingdom registration number

[15] 註冊日期 Registration date / 當作註冊日期 Deemed registration date / 聯合王國註冊日期 United Kingdom registration date

[17] 註冊有效期屆滿日期 Expiry date of the period of registration

[22] 提交日期 Filing date / 當作提交日期 Deemed filing date / 聯合王國提交日期 United Kingdom filing date

[30] 聲稱享有的優先權（提交日期 / 巴黎公約國或世界貿易組織成員 / 申請編號） Priority claimed (filing date / Paris Convention country or WTO member / application number)

[51] 國際外觀設計分類號（洛迦諾分類號） International Classification of designs (Locarno Classification)

[54] 物品 Article

[55] 外觀設計的表述 Representation of the design

[62] 分開前的申請編號及提交日期 Application number before division and filing date

[66] 過往註冊的聯繫外觀設計註冊編號 / 日期 Registration No. / Date of Previous Registration for Association

[72] 設計人 Designer

[73] 擁有人姓名和地址 Name and address of the owner

[74] 代理人 Agent / 送達地址 Address for service



香港特別行政區政府知識產權署外觀設計註冊處

The Government of the Hong Kong Special Administrative Region

Designs Registry, Intellectual Property Department

## 根據註冊外觀設計條例第 25 條註冊的外觀設計

### Designs registered under section 25 of the Registered Designs Ordinance

按註冊編號排列

Arranged by Registration Number

- [11] 2422741.5
- [15] 25-01-2024
- [30] 27-07-2023 / KR / 30-2023-0029197
- [51] Cl. 27-07
- [54] 電子煙  
Electronic cigarette
- [73] KT&G Corporation  
71, Beotkkot-gil,  
Daedeok-gu, Daejeon,  
Republic of Korea
- [74] MARKS & CLERK  
Level 9, Cyberport 1,  
100 Cyberport Road,  
Pok Fu Lam, Hong Kong

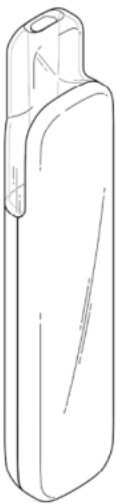

- 
- [11] 2422742.7
  - [15] 25-01-2024

[30] 27-07-2023 / KR / 30-2023-0029239

[51] Cl. 27-07

[54] 電子煙

Electronic cigarette

[73] KT&G Corporation

71, Beotkkot-gil,

Daedeok-gu, Daejeon,

Republic of Korea

[74] MARKS & CLERK

Level 9, Cyberport 1,

100 Cyberport Road,

Pok Fu Lam, Hong Kong

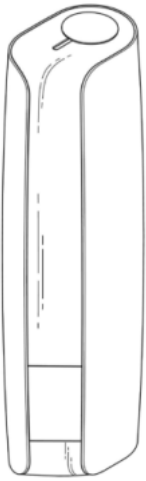

---

[11] 2422809.0M001

[15] 10-02-2024

[30] 19-10-2023 / CN / 2023306778100

[51] Cl. 26-05

[54] 天花燈

Ceiling light

[73] 廣東正大電氣照明有限公司

中國肇慶市高要區金利鎮

肇星五金表面技術處理工業園內

(鄒曦雲廠房之二)

[74] 港智國際知識產權代理有限公司

香港屯門

震寰路 3 號

德榮工業大廈 21 字樓 B11 室

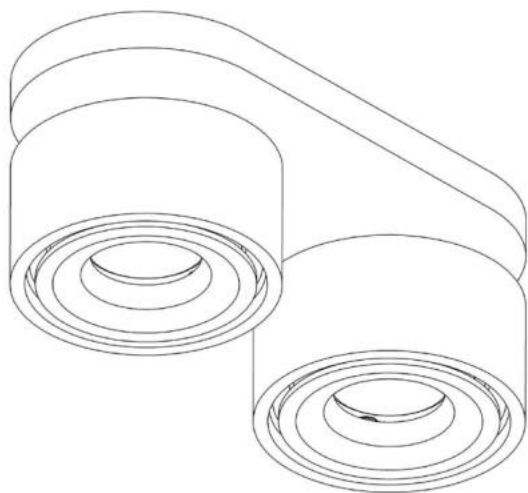

---

[11] 2422809.0M002

[15] 10-02-2024

[30] 19-10-2023 / CN / 2023306778100

[51] Cl. 26-05

[54] 天花燈

Ceiling light

[73] 廣東正大電氣照明有限公司

中國肇慶市高要區金利鎮

肇星五金表面技術處理工業園內

(鄒曦雲廠房之二)

[74] 港智國際知識產權代理有限公司

香港屯門

震寰路3號

德榮工業大廈21字樓B11室

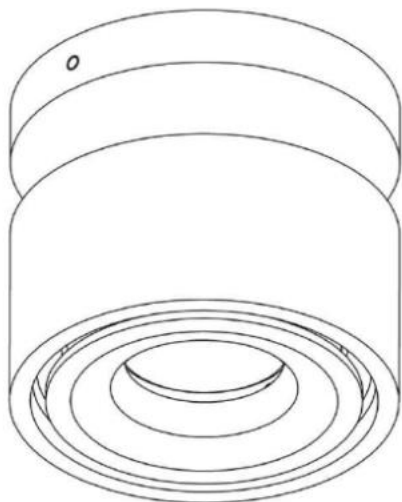



- [11] 2422835.5  
[15] 22-02-2024  
[30] 24-08-2023 / DE / 40 2023 100 594.9  
[51] Cl. 12-08  
[54] 汽車  
Motor vehicle  
[73] VOLKSWAGEN AKTIENGESELLSCHAFT  
Berliner Ring 2,  
38440 Wolfsburg,  
Germany  
[74] CHINA PATENT AGENT (HONG KONG) LIMITED  
22/F, Great Eagle Centre,  
23 Harbour Road,  
Wanchai, Hong Kong



- 
- [11] 2422836.7  
[15] 22-02-2024  
[30] 24-08-2023 / DE / 40 2023 100 594.9  
[51] Cl. 21-01  
[54] 玩具車  
Toy vehicle  
[73] VOLKSWAGEN AKTIENGESELLSCHAFT  
Berliner Ring 2,  
38440 Wolfsburg,  
Germany  
[74] CHINA PATENT AGENT (HONG KONG) LIMITED  
22/F, Great Eagle Centre,  
23 Harbour Road,  
Wanchai, Hong Kong



---

[11] 2422847.0

[15] 23-02-2024

[30] 24-08-2023 / CA, MX, CN, SG, CH, TR, GB, US, EU, JP, KR /  
DM/233684

[51] Cl. 24-02

[54] 實驗室移液器

Laboratory pipette

[73] 埃佩多夫歐洲股份公司

EPPENDORF SE

Barkhausenweg 1,

D-22339 Hamburg,

Germany

[74] CLT PATENT & TRADEMARK (H.K.) LIMITED

Unit 09, 34/F., Office Tower, Convention Plaza,

1 Harbour Road,

Wanchai, Hong Kong



---

[11] 2422878.5

[15] 03-03-2024

[51] Cl. 9-03

[54] 香水包裝

Perfume packaging

[73] Fendi s.r.l.

Palazzo della Civiltà Italiana,  
Quadrato della Concordia, 3,  
I-00144 Roma, Italy

[74] MELVIN LI INTELLECTUAL PROPERTY LIMITED

Level 35, Two Pacific Place,  
88 Queensway,  
Admiralty, Hong Kong

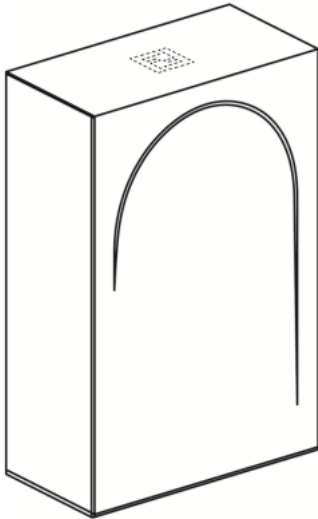

---

[11] 2422917.9

[15] 08-03-2024

[30] 20-11-2023 / JP / 023940 of 2023

[51] Cl. 7-01

[54] 飲品瓶

Beverage bottle

[73] 玻璃王株式會社

HARIO Co., Ltd.  
9-3, Nihonbashi Tomizawa-Cho,  
Chuo-Ku, Tokyo 103-0006,  
Japan

[74] CHINA PATENT AGENT (HONG KONG) LIMITED

22/F, Great Eagle Centre,  
23 Harbour Road,  
Wanchai, Hong Kong

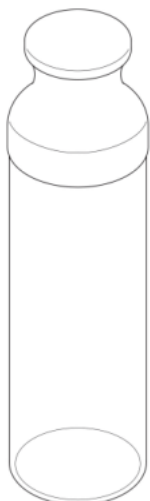

---

[11] 2422919.3

[15] 08-03-2024

[30] 08-09-2023 / NO / 20230903

[51] Cl. 6-01

[54] 嬰兒搖椅

Baby bouncer seat

[73] Stokke AS

Parkgata 6,

6003 Ålesund,

Norway

[74] AWA ASIA LIMITED

Suite 1411, 14/F, Leighton Centre,

77 Leighton Road,

Causeway Bay, Hong Kong

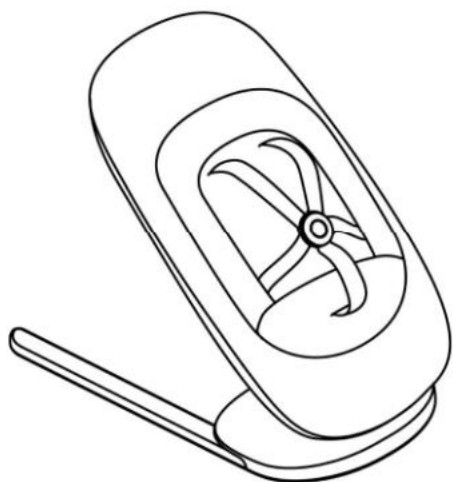

- [11] 2422937.1M001  
[15] 12-03-2024  
[30] 12-09-2023 / US / 29/912,028  
[51] Cl. 10-07  
[54] 用於可穿戴設備的帶  
Band for wearable device  
[73] 蘋果公司  
APPLE INC.  
One Apple Park Way, Cupertino,  
California,  
United States of America  
[74] CLT PATENT & TRADEMARK (H.K.) LIMITED  
Unit 09, 34/F., Office Tower, Convention Plaza,  
1 Harbour Road,  
Wanchai, Hong Kong



- 
- [11] 2422937.1M002  
[15] 12-03-2024  
[30] 12-09-2023 / US / 29/912,028  
[51] Cl. 10-07  
[54] 用於可穿戴設備的帶  
Band for wearable device  
[73] 蘋果公司  
APPLE INC.  
One Apple Park Way, Cupertino,  
California,  
United States of America  
[74] CLT PATENT & TRADEMARK (H.K.) LIMITED  
Unit 09, 34/F., Office Tower, Convention Plaza,

1 Harbour Road,  
Wanchai, Hong Kong



---

[11] 2423061.3

[15] 29-03-2024

[51] C1. 12-11

[54] 自行車鞍座  
Bicycle saddle

[73] 香港理工大学  
THE HONG KONG POLYTECHNIC UNIVERSITY  
香港  
九龙红磡育才道 11 号

[74] 中一聯合國際知識產權有限公司  
香港九龍觀塘  
興業街 20 號  
聯合興業工業大廈 5 樓 A26 室

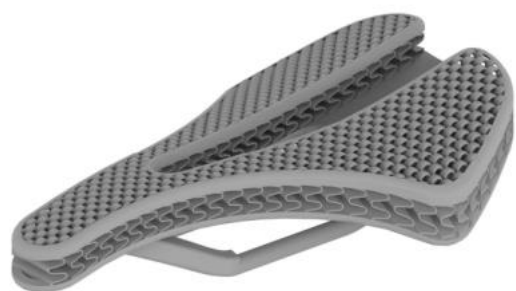

---

[11] 2423089.2

[15] 08-04-2024

[30] 28-03-2024 / CA, MC, SG, CH, GB, EU, JP, KR / DM/237349

[51] Cl. 11-01

[54] 項鏈

Necklace

[73] Chaumet International S.A.

12 Place Vendôme,

75001 Paris,

France

[74] WENPING PATENT & TRADE MARK AGENT LIMITED

1701 Tung Wai Commercial Building,

111 Gloucester Road,

Hong Kong



---

[11] 2423090.4

[15] 08-04-2024

[30] 28-03-2024 / CA, MC, SG, CH, GB, EU, JP, KR / DM/237349

[51] Cl. 11-01

[54] 項鏈

Necklace

[73] Chaumet International S.A.

12 Place Vendôme,

75001 Paris,

France

[74] WENPING PATENT & TRADE MARK AGENT LIMITED

1701 Tung Wai Commercial Building,

111 Gloucester Road,

Hong Kong



---

[11] 2423091.6

[15] 08-04-2024

[30] 28-03-2024 / CA, MC, SG, CH, GB, EU, JP, KR / DM/237349

[51] Cl. 11-01

[54] 項鏈

Necklace

[73] Chaumet International S.A.

12 Place Vendôme,

75001 Paris,

France

[74] WENPING PATENT & TRADE MARK AGENT LIMITED

1701 Tung Wai Commercial Building,

111 Gloucester Road,

Hong Kong



---

[11] 2423092.8

[15] 08-04-2024

[30] 28-03-2024 / CA, MC, SG, CH, GB, EU, JP, KR / DM/237349

[51] Cl. 11-01

[54] 耳環

Earring



[73] Chaumet International S.A.  
12 Place Vendôme,  
75001 Paris,  
France

[74] WENPING PATENT & TRADE MARK AGENT LIMITED  
1701 Tung Wai Commercial Building,  
111 Gloucester Road,  
Hong Kong



---

[11] 2423125.0

[15] 12-04-2024

[30] 27-10-2023 / CN / 2023306997076

[51] Cl. 12-08

[54] 影視作業車

Vehicles used for film and television photography

[73] 神力视界(深圳)文化科技有限公司

Divine Vision (Shenzhen) Culture Technology Co., Ltd.

中國

518067 广东省深圳市南山区粤海街道蔚蓝海岸社区

科苑路 3239 号阿里云大厦 S1 栋 602

[74] 三友知識產權代理有限公司

香港

德輔道中 188 號

金龍中心 23 樓 2301 室



---

[11] 2423127.4

[15] 12-04-2024

[51] Cl. 6-07

[54] 運動鏡

Fitness mirror

[73] 趣动未来(深圳)科技有限公司

Qudong Future (Shenzhen) Technology Co., Ltd

中國

广东省深圳市南山区招商街道沿山社区

南海大道 1031 号万海大厦 A 座 1001

[74] HONG KONG DECENT INTELLECTUAL PROPERTY AGENT LIMITED

香港

文咸東街 78 號

華東商業大廈三樓



---

[11] 2423177.9M001

[15] 19-04-2024

[30] 16-11-2023 / EU / 015041315-0001

[51] Cl. 28-03

[54] 修剪器手柄

Handle for trimmer

[73] Koninklijke Philips N.V.

High Tech Campus 52,

5656 AG Eindhoven,

Netherlands

[74] ROUSE & CO. INTERNATIONAL (OVERSEAS) LIMITED

26/F., Tesbury Centre,

28 Queen's Road East,

Hong Kong

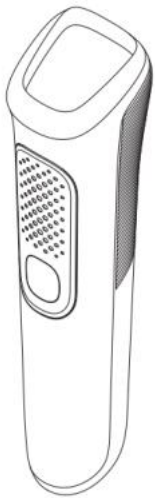

---

[11] 2423177.9M002

[15] 19-04-2024

[30] 16-11-2023 / EU / 015041315-0002

[51] Cl. 28-03

[54] 修剪器手柄

Handle for trimmer

[73] Koninklijke Philips N.V.

High Tech Campus 52,

5656 AG Eindhoven,

Netherlands

[74] ROUSE & CO. INTERNATIONAL (OVERSEAS) LIMITED

26/F., Tesbury Centre,

28 Queen's Road East,

Hong Kong



---

[11] 2423177.9M003

[15] 19-04-2024

[30] 16-11-2023 / EU / 015041315-0003

[51] Cl. 28-03

[54] 修剪器手柄

Handle for trimmer

[73] Koninklijke Philips N.V.

High Tech Campus 52,

5656 AG Eindhoven,

Netherlands

[74] ROUSE & CO. INTERNATIONAL (OVERSEAS) LIMITED

26/F., Tesbury Centre,

28 Queen's Road East,

Hong Kong

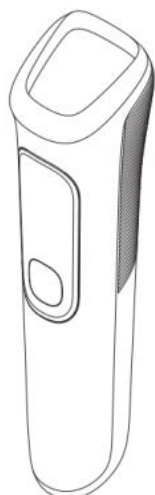

- [11] 2423177.9M004
- [15] 19-04-2024
- [30] 16-11-2023 / EU / 015041315-0004
- [51] Cl. 28-03
- [54] 修剪器  
Trimmer
- [73] Koninklijke Philips N.V.  
High Tech Campus 52,  
5656 AG Eindhoven,  
Netherlands
- [74] ROUSE & CO. INTERNATIONAL (OVERSEAS) LIMITED  
26/F., Tesbury Centre,  
28 Queen's Road East,  
Hong Kong

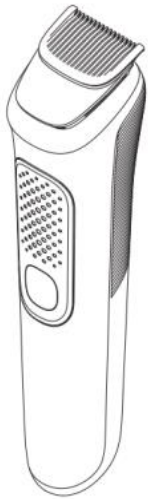

- 
- [11] 2423177.9M005
  - [15] 19-04-2024
  - [30] 16-11-2023 / EU / 015041315-0005
  - [51] Cl. 28-03
  - [54] 修剪器  
Trimmer
  - [73] Koninklijke Philips N.V.  
High Tech Campus 52,  
5656 AG Eindhoven,  
Netherlands
  - [74] ROUSE & CO. INTERNATIONAL (OVERSEAS) LIMITED  
26/F., Tesbury Centre,  
28 Queen's Road East,  
Hong Kong



---

[11] 2423239.1

[15] 28-04-2024

[51] Cl. 24-01

[54] 內窺鏡操作站

A station for operating an endoscope

[73] Agilis Robotics Limited

Room 630, 6/F, Block 17, No. 17,  
Science Park West Avenue, Pak Shek Kok,  
Hong Kong

[74] LECTO IP LIMITED

Unit 503, 5/F, Tower 2 Lippo Centre,  
89 Queensway, Admiralty,  
Hong Kong

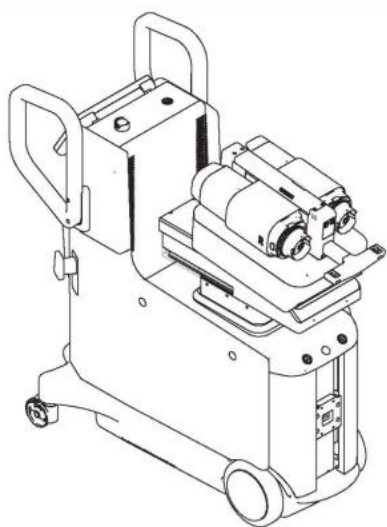

---

[11] 2423373.4M001

[15] 23-05-2024

[51] Cl. 19-08

[54] 包裝標籤

Packaging label

[73] 亞倫亞當有限公司

Aaron Adam Limited

Unit A, 15/F, Block 1, Leader Industrial Centre,  
188-202 Texaco Road, Tsuen Wan,  
Hong Kong

[74] Aaron Adam Limited

Unit A, 15/F, Block 1, Leader Industrial Centre,  
188-202 Texaco Road, Tsuen Wan,  
Hong Kong

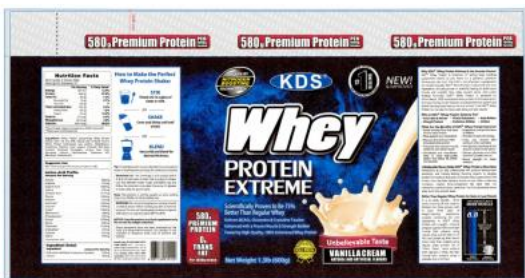

[11] 2423373.4M002

[15] 23-05-2024

[51] Cl. 19-08

[54] 包裝標籤

Packaging label

[73] 亞倫亞當有限公司

Aaron Adam Limited

Unit A, 15/F, Block 1, Leader Industrial Centre,  
188-202 Texaco Road, Tsuen Wan,  
Hong Kong

[74] Aaron Adam Limited

Unit A, 15/F, Block 1, Leader Industrial Centre,  
188-202 Texaco Road, Tsuen Wan,  
Hong Kong

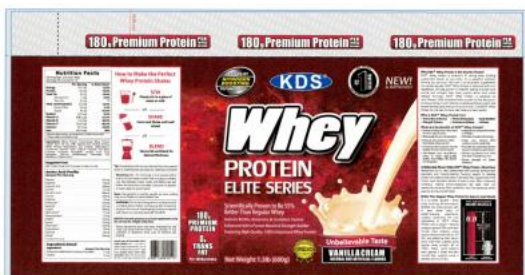

[11] 2423373.4M003

[15] 23-05-2024

[51] Cl. 19-08

[54] 包裝標籤

Packaging label

[73] 亞倫亞當有限公司

Aaron Adam Limited

Unit A, 15/F, Block 1, Leader Industrial Centre,  
188-202 Texaco Road, Tsuen Wan,  
Hong Kong

[74] Aaron Adam Limited

Unit A, 15/F, Block 1, Leader Industrial Centre,  
188-202 Texaco Road, Tsuen Wan,  
Hong Kong



[11] 2423373.4M004

[15] 23-05-2024

[51] Cl. 19-08

[54] 包裝標籤

Packaging label

[73] 亞倫亞當有限公司

Aaron Adam Limited

Unit A, 15/F, Block 1, Leader Industrial Centre,  
188-202 Texaco Road, Tsuen Wan,  
Hong Kong

[74] Aaron Adam Limited

Unit A, 15/F, Block 1, Leader Industrial Centre,  
188-202 Texaco Road, Tsuen Wan,  
Hong Kong



[11] 2423373.4M005

[15] 23-05-2024

[51] Cl. 19-08



[54] 包裝標籤  
Packaging label

[73] 亞倫亞當有限公司  
Aaron Adam Limited  
Unit A, 15/F, Block 1, Leader Industrial Centre,  
188-202 Texaco Road, Tsuen Wan,  
Hong Kong

[74] Aaron Adam Limited  
Unit A, 15/F, Block 1, Leader Industrial Centre,  
188-202 Texaco Road, Tsuen Wan,  
Hong Kong



---

[11] 2423373.4M006

[15] 23-05-2024

[51] Cl. 19-08

[54] 包裝標籤  
Packaging label

[73] 亞倫亞當有限公司  
Aaron Adam Limited  
Unit A, 15/F, Block 1, Leader Industrial Centre,  
188-202 Texaco Road, Tsuen Wan,  
Hong Kong

[74] Aaron Adam Limited  
Unit A, 15/F, Block 1, Leader Industrial Centre,  
188-202 Texaco Road, Tsuen Wan,  
Hong Kong



---

[11] 2423373.4M007

[15] 23-05-2024

[51] Cl. 19-08

[54] 包裝標籤  
Packaging label

[73] 亞倫亞當有限公司  
Aaron Adam Limited  
Unit A, 15/F, Block 1, Leader Industrial Centre,  
188-202 Texaco Road, Tsuen Wan,  
Hong Kong

[74] Aaron Adam Limited  
Unit A, 15/F, Block 1, Leader Industrial Centre,  
188-202 Texaco Road, Tsuen Wan,  
Hong Kong



[11] 2423373.4M008

[15] 23-05-2024

[51] Cl. 19-08

[54] 包裝標籤  
Packaging label

[73] 亞倫亞當有限公司  
Aaron Adam Limited  
Unit A, 15/F, Block 1, Leader Industrial Centre,  
188-202 Texaco Road, Tsuen Wan,  
Hong Kong

[74] Aaron Adam Limited  
Unit A, 15/F, Block 1, Leader Industrial Centre,  
188-202 Texaco Road, Tsuen Wan,  
Hong Kong



[11] 2423373.4M009

[15] 23-05-2024

[51] Cl. 19-08

[54] 包裝標籤  
Packaging label

[73] 亞倫亞當有限公司  
Aaron Adam Limited  
Unit A, 15/F, Block 1, Leader Industrial Centre,  
188-202 Texaco Road, Tsuen Wan,  
Hong Kong

[74] Aaron Adam Limited  
Unit A, 15/F, Block 1, Leader Industrial Centre,  
188-202 Texaco Road, Tsuen Wan,  
Hong Kong



[11] 2423373.4M010

[15] 23-05-2024

[51] Cl. 19-08

[54] 包裝標籤  
Packaging label

[73] 亞倫亞當有限公司  
Aaron Adam Limited  
Unit A, 15/F, Block 1, Leader Industrial Centre,  
188-202 Texaco Road, Tsuen Wan,  
Hong Kong

[74] Aaron Adam Limited  
Unit A, 15/F, Block 1, Leader Industrial Centre,  
188-202 Texaco Road, Tsuen Wan,  
Hong Kong



[11] 2423410.4

[15] 30-05-2024

[30] 22-03-2024 / SG / 30202400312Y

[51] Cl. 28-01

[54] 壓縮粉片

Compressed powder tablet

[73] ECO LUXURY LIFESTYLE PTE. LTD.

9 YISHUN INDUSTRIAL STREET 1, # 02-74,  
NORTH SPRING BIZHUB, SINGAPORE 768163,  
SINGAPORE

[74] ACCOLADE IP LIMITED

10/F, Fu Fai Comm. Ctr.,  
27 Hillier Street, Sheung Wan,  
Hong Kong

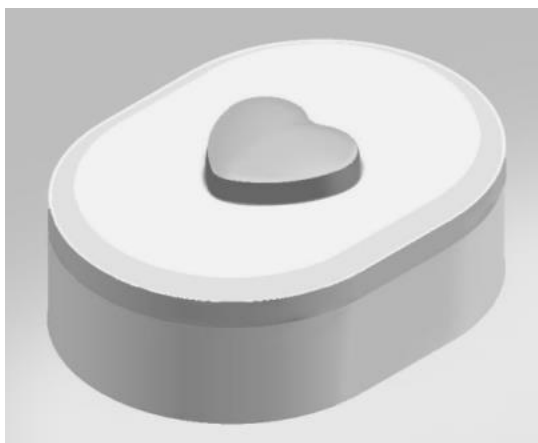

---

[11] 2423412.8

[15] 30-05-2024

[30] 15-04-2024 / KR / 30-2024-0014625

[51] Cl. 8-07

[54] 數位門鎖配件

Accessory for digital door lock

[73] ZIGBANG CO., LTD.

B2, 731, Yeongdong-daero,  
Gangnam-gu, Seoul,  
Republic of Korea

[74] VIVIEN CHAN & CO

32/F, Harbour Centre,  
25 Harbour Road, Wanchai,  
Hong Kong

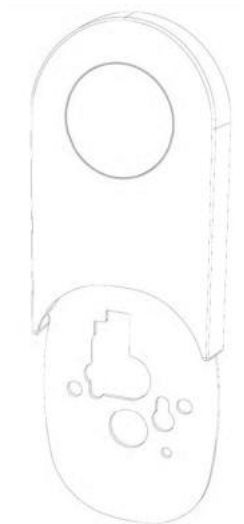

---

[11] 2423413.0

[15] 30-05-2024

[30] 01-12-2023 / KR / 30-2023-0048597

[51] Cl. 8-06

[54] 數位門鎖手柄

Handle for digital door lock

[73] ZIGBANG CO., LTD.

B2, 731, Yeongdong-daero,

Gangnam-gu, Seoul,

Republic of Korea

[74] VIVIEN CHAN & CO

32/F, Harbour Centre,

25 Harbour Road, Wanchai,

Hong Kong

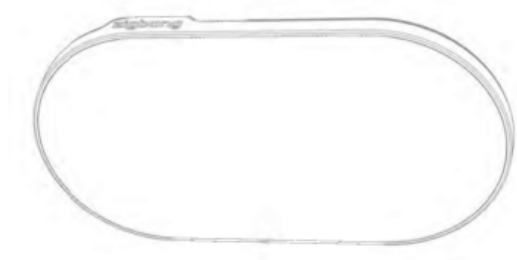

---

[11] 2423414.2

[15] 30-05-2024

[30] 15-04-2024 / KR / 30-2024-0014624

[51] Cl. 8-07

[54] 內部數位門鎖

Digital door lock for the inside

[73] ZIGBANG CO., LTD.  
B2, 731, Yeongdong-daero,  
Gangnam-gu, Seoul,  
Republic of Korea

[74] VIVIEN CHAN & CO  
32/F, Harbour Centre,  
25 Harbour Road, Wanchai,  
Hong Kong

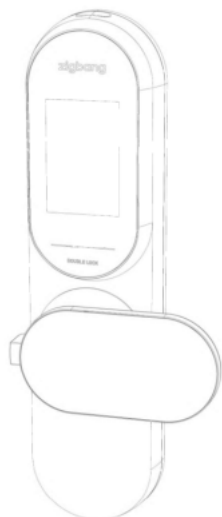

---

[11] 2423415.5M001

[15] 30-05-2024

[51] Cl. 11-01

[54] 首飾  
Jewellery

[73] 周生生珠寶金行有限公司  
Chow Sang Sang Jewellery Company Limited  
4/F., Chow Sang Sang Building,  
229 Nathan Road, Kowloon,  
Hong Kong

[74] HKIPA LIMITED  
Unit 230, 2/F, Building 12W,  
No. 12 Science Park West Avenue,  
Phase 3, Hong Kong Science Park, Pak Shek Kok,  
New Territories, Hong Kong

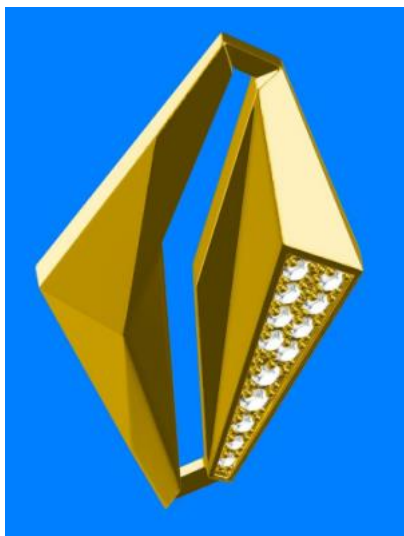

---

[11] 2423415.5M002

[15] 30-05-2024

[51] Cl. 11-01

[54] 首飾

Jewellery

[73] 周生生珠寶金行有限公司

Chow Sang Sang Jewellery Company Limited

4/F., Chow Sang Sang Building,

229 Nathan Road, Kowloon,

Hong Kong

[74] HKIPA LIMITED

Unit 230, 2/F, Building 12W,

No. 12 Science Park West Avenue,

Phase 3, Hong Kong Science Park, Pak Shek Kok,

New Territories, Hong Kong



[11] 2423415.5M003

[15] 30-05-2024

[51] Cl. 11-01

[54] 首飾

Jewellery

[73] 周生生珠寶金行有限公司

Chow Sang Sang Jewellery Company Limited

4/F., Chow Sang Sang Building,

229 Nathan Road, Kowloon,

Hong Kong

[74] HKIPA LIMITED

Unit 230, 2/F, Building 12W,

No. 12 Science Park West Avenue,

Phase 3, Hong Kong Science Park, Pak Shek Kok,

New Territories, Hong Kong

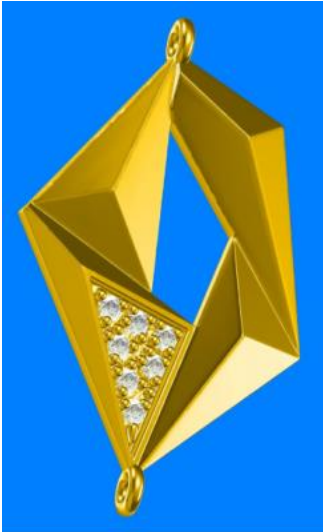

---

[11] 2423415.5M004

[15] 30-05-2024

[51] Cl. 11-01

[54] 首飾

Jewellery

[73] 周生生珠寶金行有限公司

Chow Sang Sang Jewellery Company Limited

4/F., Chow Sang Sang Building,

229 Nathan Road, Kowloon,

Hong Kong

[74] HKIPA LIMITED

Unit 230, 2/F, Building 12W,

No. 12 Science Park West Avenue,



Phase 3, Hong Kong Science Park, Pak Shek Kok,  
New Territories, Hong Kong

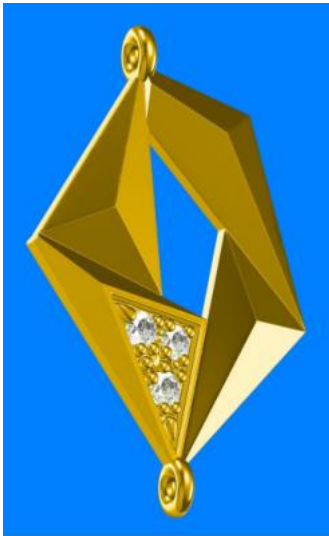

---

[11] 2423415.5M005

[15] 30-05-2024

[51] Cl. 11-01

[54] 首飾

Jewellery

[73] 周生生珠寶金行有限公司

Chow Sang Sang Jewellery Company Limited

4/F., Chow Sang Sang Building,

229 Nathan Road, Kowloon,

Hong Kong

[74] HKIPA LIMITED

Unit 230, 2/F, Building 12W,

No. 12 Science Park West Avenue,

Phase 3, Hong Kong Science Park, Pak Shek Kok,

New Territories, Hong Kong



---

[11] 2423415.5M006

[15] 30-05-2024

[51] Cl. 11-01

[54] 首飾

Jewellery

[73] 周生生珠寶金行有限公司

Chow Sang Sang Jewellery Company Limited

4/F., Chow Sang Sang Building,

229 Nathan Road, Kowloon,

Hong Kong

[74] HKIPA LIMITED

Unit 230, 2/F, Building 12W,

No. 12 Science Park West Avenue,

Phase 3, Hong Kong Science Park, Pak Shek Kok,

New Territories, Hong Kong



[11] 2423415.5M007

[15] 30-05-2024

[51] Cl. 11-01

[54] 首飾

Jewellery

[73] 周生生珠寶金行有限公司

Chow Sang Sang Jewellery Company Limited

4/F., Chow Sang Sang Building,

229 Nathan Road, Kowloon,

Hong Kong

[74] HKIPA LIMITED

Unit 230, 2/F, Building 12W,

No. 12 Science Park West Avenue,

Phase 3, Hong Kong Science Park, Pak Shek Kok,

New Territories, Hong Kong



[11] 2423415.5M008

[15] 30-05-2024

[51] Cl. 11-01

[54] 首飾

Jewellery

[73] 周生生珠寶金行有限公司

Chow Sang Sang Jewellery Company Limited

4/F., Chow Sang Sang Building,

229 Nathan Road, Kowloon,

Hong Kong

[74] HKIPA LIMITED

Unit 230, 2/F, Building 12W,

No. 12 Science Park West Avenue,

Phase 3, Hong Kong Science Park, Pak Shek Kok,  
New Territories, Hong Kong



---

[11] 2423415.5M009

[15] 30-05-2024

[51] Cl. 11-01

[54] 首飾

Jewellery

[73] 周生生珠寶金行有限公司

Chow Sang Sang Jewellery Company Limited

4/F., Chow Sang Sang Building,

229 Nathan Road, Kowloon,

Hong Kong

[74] HKIPA LIMITED

Unit 230, 2/F, Building 12W,

No. 12 Science Park West Avenue,

Phase 3, Hong Kong Science Park, Pak Shek Kok,

New Territories, Hong Kong

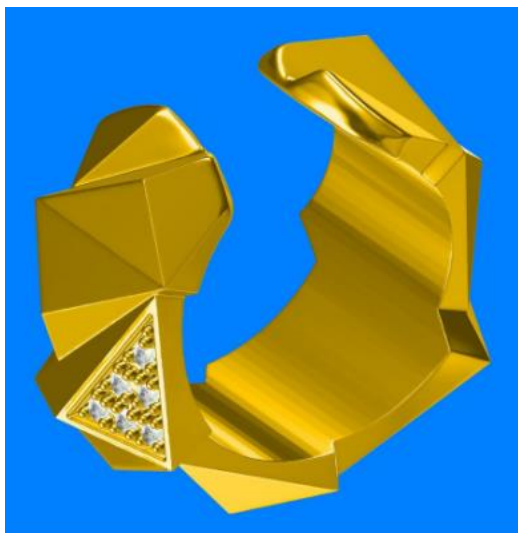

---

[11] 2423415.5M010

[15] 30-05-2024

[51] Cl. 11-01

[54] 首飾

Jewellery

[73] 周生生珠寶金行有限公司

Chow Sang Sang Jewellery Company Limited

4/F., Chow Sang Sang Building,

229 Nathan Road, Kowloon,

Hong Kong

[74] HKIPA LIMITED

Unit 230, 2/F, Building 12W,

No. 12 Science Park West Avenue,

Phase 3, Hong Kong Science Park, Pak Shek Kok,

New Territories, Hong Kong

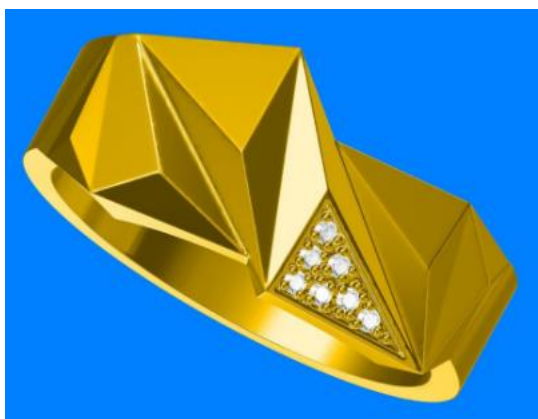

---

[11] 2423415.5M011

[15] 30-05-2024

[51] Cl. 11-01

[54] 首飾  
Jewellery

[73] 周生生珠寶金行有限公司  
Chow Sang Sang Jewellery Company Limited  
4/F., Chow Sang Sang Building,  
229 Nathan Road, Kowloon,  
Hong Kong

[74] HKIPA LIMITED  
Unit 230, 2/F, Building 12W,  
No. 12 Science Park West Avenue,  
Phase 3, Hong Kong Science Park, Pak Shek Kok,  
New Territories, Hong Kong

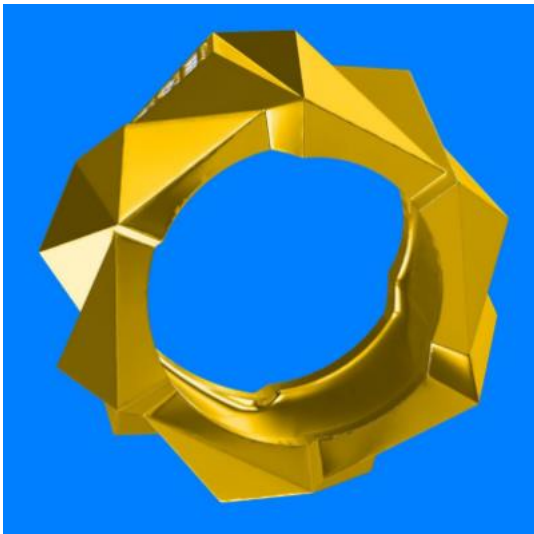

---

[11] 2423416.7M001

[15] 30-05-2024

[30] 12-12-2023 / JP / 2023-025835

[51] Cl. 28-03

[54] 指甲切割輔助工具  
Auxiliary tool for nail clipping

[73] Combi Corporation  
6-7, Motoasakusa 2-chome,  
Taito-ku, Tokyo 111-0041,  
Japan

[74] WILKINSON & GRIST  
6th Floor, Prince's Building,  
Chater Road, Central,  
Hong Kong



---

[11] 2423416.7M002

[15] 30-05-2024

[30] 12-12-2023 / JP / 2023-025836

[51] Cl. 28-03

[54] 指甲切割輔助工具

Auxiliary tool for nail clipping

[73] Combi Corporation

6-7, Motoasakusa 2-chome,  
Taito-ku, Tokyo 111-0041,  
Japan

[74] WILKINSON & GRIST

6th Floor, Prince's Building,  
Chater Road, Central,  
Hong Kong

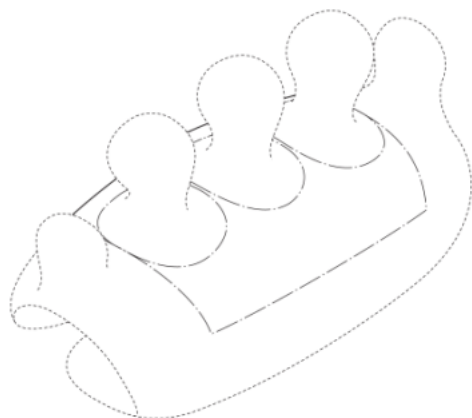

---

[11] 2423418.1

[15] 30-05-2024

[30] 30-11-2023 / CN / 202330789747X

- [51] Cl. 7-02
- [54] 空氣炸鍋  
Airfryer
- [73] 布鲁诺株式会社  
BRUNO, INC.  
36F, Sumitomo Fudousan Shinjuku Grand Tower,  
8-17-1, Nishi-Shinjuku, Shinjuku City,  
Tokyo 160-0023,  
Japan
- [74] BIRD & BIRD  
6/F, The Annex, Central Plaza,  
18 Harbour Road,  
Hong Kong

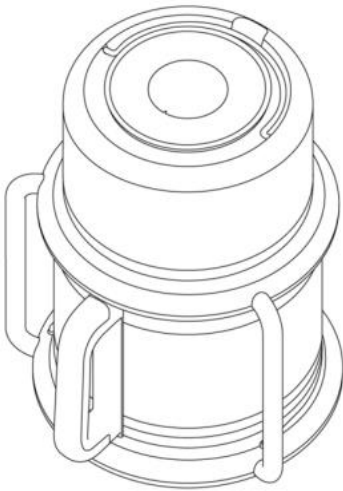

- 
- [11] 2423419.3
- [15] 30-05-2024
- [30] 30-11-2023 / CN / 2023307897427
- [51] Cl. 7-02
- [54] 豆漿機  
Soy milk maker
- [73] 布鲁诺株式会社  
BRUNO, INC.  
36F, Sumitomo Fudousan Shinjuku Grand Tower,  
8-17-1, Nishi-Shinjuku, Shinjuku City,  
Tokyo 160-0023,  
Japan
- [74] BIRD & BIRD  
6/F, The Annex, Central Plaza,  
18 Harbour Road,  
Hong Kong



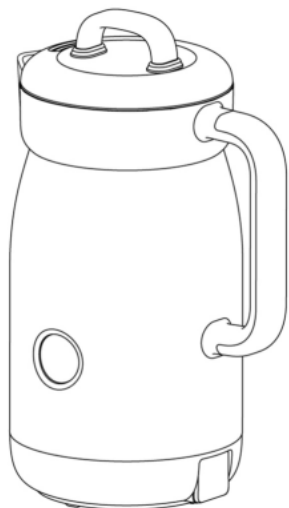

---

[11] 2423431.8

[15] 31-05-2024

[30] 29-02-2024 / RU, SG, CH, TR, GB, EU / DM/236254

[51] Cl. 11-01

[54] 耳環

Earrings

[73] VAN CLEEF & ARPELS SA

Route des Biches 8,  
1752 Villars-sur-Glâne,  
Switzerland

[74] ATL LAW OFFICES

16/F., China Hong Kong Tower,  
8-12 Hennessy Road, Wanchai,  
Hong Kong

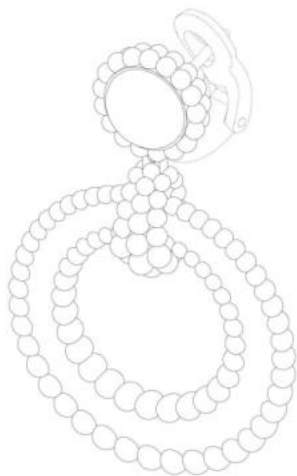

- [11] 2423433.2  
[15] 31-05-2024  
[30] 29-02-2024 / RU, SG, CH, TR, GB, EU / DM/236243  
[51] Cl. 11-01  
[54] 耳環  
Earrings  
[73] VAN CLEEF & ARPELS SA  
Route des Biches 8,  
1752 Villars-sur-Glâne,  
Switzerland  
[74] ATL LAW OFFICES  
16/F., China Hong Kong Tower,  
8-12 Hennessy Road, Wanchai,  
Hong Kong

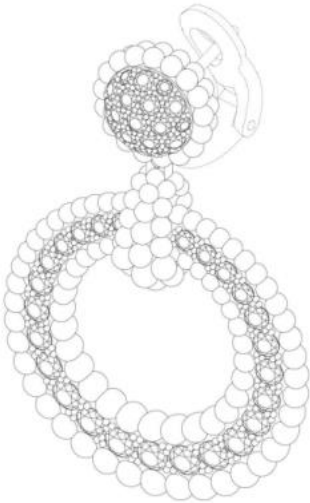

- 
- [11] 2423475.1  
[15] 05-06-2024  
[30] 05-12-2023 / US / 29/919,657  
[51] Cl. 9-01  
[54] 瓶蓋  
Bottle cap  
[73] LoveShackFancy, LLC  
210 11th Avenue, New York 10001,  
United States of America  
[74] ORIENTAL INTELLECTUAL PROPERTY SERVICES CO.  
Flat B, 38/F, South Tower 3, Phase 2,  
Residence Bal-Air,  
Hong Kong

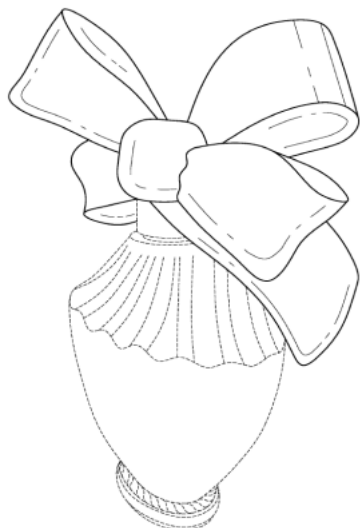

---

[11] 2423494.0

[15] 07-06-2024

[30] 15-03-2024 / GB / 6353383

[51] Cl. 28-06

[54] 頭髮造型和頭髮護理裝置 (的附件)

Hair styling and hair care apparatus (accessories for-)

[73] Dyson Technology Limited

Tetbury Hill, Malmesbury, Wiltshire, SN16 0RP,  
United Kingdom

[74] LIU, SHEN & ASSOCIATES

Room 3716, 37/F, Sun Hung Kai Centre,  
30 Harbour Road, Wanchai,  
Hong Kong

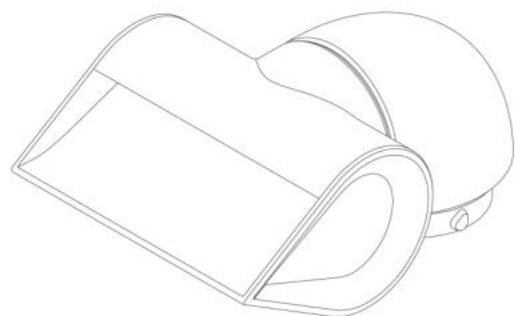

---

[11] 2423496.5M001

[15] 07-06-2024

[30] 28-03-2024 / MA, CN, RS, SG, CH, TR, UA, US, EU, JP, KR /  
DM/236394

[51] Cl. 10-02

[54] 手錶

Watch

[73] CHOPARD INTERNATIONAL SA

Route de Promenthoux,  
Prangins,  
Switzerland

[74] WILKINSON & GRIST

6th Floor, Prince's Building,  
Chater Road,  
Hong Kong



---

[11] 2423496.5M002

[15] 07-06-2024

[30] 28-03-2024 / MA, CN, RS, SG, CH, TR, UA, US, EU, JP, KR /  
DM/236445

[51] Cl. 10-02

[54] 手錶

Watch

[73] CHOPARD INTERNATIONAL SA

Route de Promenthoux,  
Prangins,  
Switzerland

[74] WILKINSON & GRIST

6th Floor, Prince's Building,  
Chater Road,  
Hong Kong



---

[11] 2423497.7

[15] 07-06-2024

[51] Cl. 11-01

[54] 戒指  
Ring

[73] Liu Ka Wan Karen  
Room A, 17/F, Man Hing Commercial Building,  
79-83 Queen's Road Central,  
Hong Kong

[74] TRADEMARKCN COMPANY LIMITED  
Block A, 4/F., Granville Building,  
14 Granville Road, Tsim Sha Tsui, Kowloon,  
Hong Kong

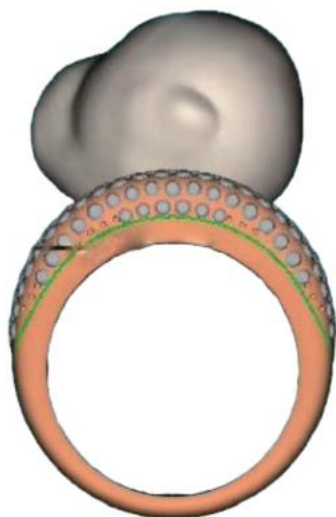

---

[11] 2423503.2M001

[15] 07-06-2024

[30] 08-12-2023 / EU / 015043813-0001

[51] Cl. 15-05

[54] 無線吸塵器

Cordless vacuum cleaner

[73] VERSUNI HOLDING B.V.

HIGH TECH CAMPUS 42, 5656AE EINDHOVEN,

NETHERLANDS

[74] CHANG TSI AND PARTNERS INTELLECTUAL PROPERTY (HK) LIMITED

Level 20, One International Finance Centre,

No. 1 Harbour View Street, Central,

Hong Kong

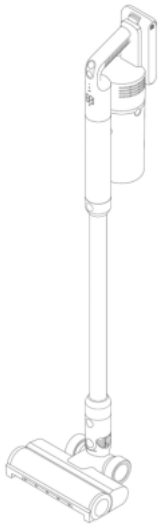

---

[11] 2423503.2M002

[15] 07-06-2024

[30] 08-12-2023 / EU / 015043813-0002

[51] Cl. 15-05

[54] 無線吸塵器

Cordless vacuum cleaner

[73] VERSUNI HOLDING B.V.

HIGH TECH CAMPUS 42, 5656AE EINDHOVEN,

NETHERLANDS

[74] CHANG TSI AND PARTNERS INTELLECTUAL PROPERTY (HK) LIMITED

Level 20, One International Finance Centre,

No. 1 Harbour View Street, Central,

Hong Kong

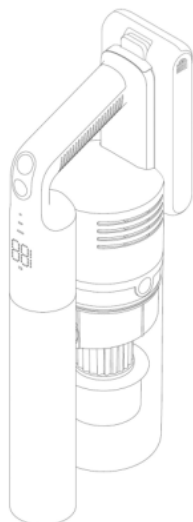

---

[11] 2423503.2M003

[15] 07-06-2024

[30] 08-12-2023 / EU / 015043813-0003

[51] Cl. 15-05

[54] 無線吸塵器

Cordless vacuum cleaner

[73] VERSUNI HOLDING B.V.

HIGH TECH CAMPUS 42, 5656AE EINDHOVEN,  
NETHERLANDS

[74] CHANG TSI AND PARTNERS INTELLECTUAL PROPERTY (HK) LIMITED

Level 20, One International Finance Centre,  
No. 1 Harbour View Street, Central,  
Hong Kong

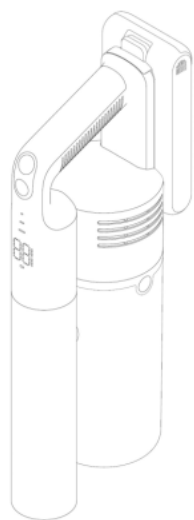

[11] 2423503.2M004

[15] 07-06-2024

[30] 08-12-2023 / EU / 015043813-0006

[51] Cl. 15-05

[54] 無線吸塵器

Cordless vacuum cleaner

[73] VERSUNI HOLDING B.V.

HIGH TECH CAMPUS 42, 5656AE EINDHOVEN,  
NETHERLANDS

[74] CHANG TSI AND PARTNERS INTELLECTUAL PROPERTY (HK) LIMITED

Level 20, One International Finance Centre,  
No. 1 Harbour View Street, Central,  
Hong Kong

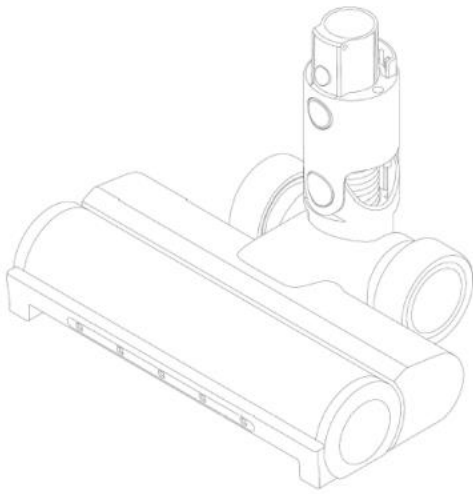

[11] 2423505.7M001

[15] 11-06-2024

[51] Cl. 7-02

[54] 小吃造型用托盤

Tray for snack molding

[73] 客樂譜株式會社

Kracie, Ltd.  
20-20, Kaigan 3-chome, Minato-ku, Tokyo,  
Japan

[74] UNION PATENT SERVICE CENTRE

Units E-F, 20th Floor, Neich Tower,  
128 Gloucester Road,  
Hong Kong





---

[11] 2423505.7M002

[15] 11-06-2024

[51] Cl. 7-02

[54] 小吃造型用托盤

Tray for snack molding

[73] 客樂譜株式會社

Kracie, Ltd.

20-20, Kaigan 3-chome, Minato-ku, Tokyo,  
Japan

[74] UNION PATENT SERVICE CENTRE

Units E-F, 20th Floor, Neich Tower,  
128 Gloucester Road,  
Hong Kong



---

[11] 2423507.1

[15] 11-06-2024

[30] 18-12-2023 / KR / 30-2023-0051591

[51] Cl. 23-04

[54] 加濕空氣清新機

Humidifying air purifier

[73] LG Jeon za Joo-sik-hoi-sa (LG Electronics Inc.)  
128, Yeoui-daero,  
Yeongdeungpo-gu, Seoul, 07336,  
Republic of Korea

[74] SPRUSON & FERGUSON (HONG KONG) LIMITED  
5001 Hopewell Centre,  
183 Queen's Road East, Wan Chai,  
Hong Kong



---

[11] 2423508.3

[15] 12-06-2024

[51] Cl. 12-07

[54] 無人機  
Drone

[73] 深圳市瑞可创新科技有限公司  
Shenzhen Ruike Innovation Technology Co., Ltd.  
中國  
深圳市龙岗区坂田街道马安堂社区  
布龙路 573 号儒峰大厦 1701

[74] 卓遠知識產權有限公司  
香港  
上環禧利街 27 號  
富輝商業中心 10 樓



- 
- [11] 2423509.5  
[15] 12-06-2024  
[51] C1. 12-07  
[54] 無人機  
Drone  
[73] 深圳市瑞可创新科技有限公司  
Shenzhen Ruike Innovation Technology Co., Ltd.  
中國  
深圳市龙岗区坂田街道马安堂社区  
布龙路 573 号儒峰大厦 1701  
[74] 卓遠知識產權有限公司  
香港  
上環禧利街 27 號  
富輝商業中心 10 樓



- 
- [11] 2423510.7  
[15] 12-06-2024  
[51] C1. 14-03  
[54] 遙控器  
Remote control  
[73] 深圳市瑞可创新科技有限公司  
Shenzhen Ruike Innovation Technology Co., Ltd.  
中國

深圳市龙岗区坂田街道马安堂社区  
布龙路 573 号儒峰大厦 1701

- [74] 卓遠知識產權有限公司  
香港  
上環禧利街 27 號  
富輝商業中心 10 樓

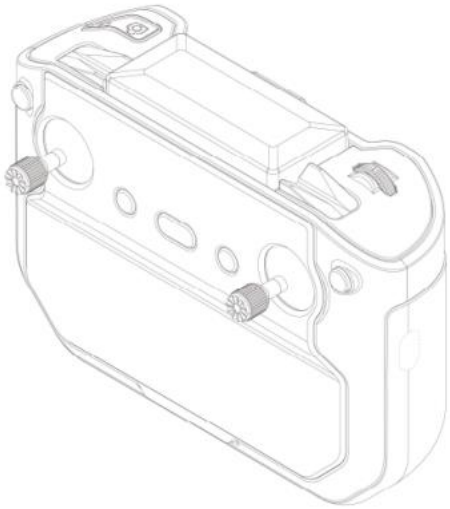

- 
- [11] 2423512.1  
[15] 13-06-2024  
[30] 07-02-2024 / JP / 2024-002678  
[51] C1. 21-01  
[54] 人形玩具的軀幹部  
Body part for toy figurine  
[73] 株式會社萬代  
BANDAI CO., LTD.  
4-8, Komagata 1-chome, Taito-ku, Tokyo,  
Japan  
[74] 范紀羅江律師行  
香港  
灣仔港灣道 6-8 號  
瑞安中心 23 樓

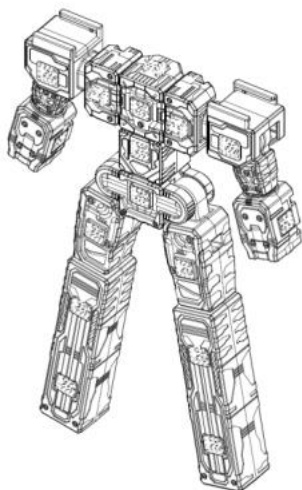

---

[11] 2423513.3

[15] 13-06-2024

[30] 07-02-2024 / JP / 2024-002679

[51] Cl. 21-01

[54] 遊戲用積木

Building block for play

[73] 株式會社萬代

BANDAI CO., LTD.

4-8, Komagata 1-chome, Taito-ku, Tokyo,  
Japan

[74] 范紀羅江律師行

香港

灣仔港灣道 6-8 號

瑞安中心 23 樓

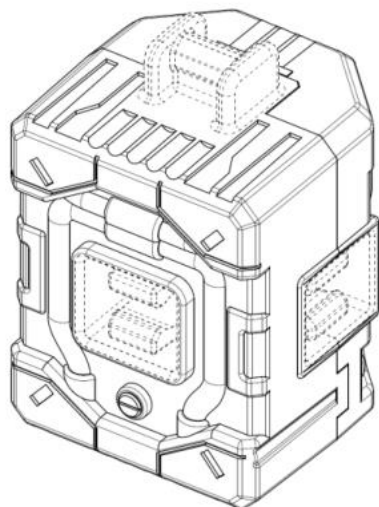

[11] 2423514.5

[15] 13-06-2024

[51] Cl. 13-02

[54] 無線充電寶

Wireless power bank

[73] 深圳市洛沃克科技有限公司

Shenzhen Loowoko Technology Co., Ltd

中國

深圳市龙岗区坂田街道新雪社区

上雪科技城北区 2 号 E 栋厂房四层、五层

[74] HONG KONG DECENT INTELLECTUAL PROPERTY AGENT LIMITED

香港

文咸東街 78 號

華東商業大廈三樓



[11] 2423515.8

[15] 13-06-2024

[51] Cl. 13-02

[54] 無線充電寶

Wireless power bank

[73] 深圳市洛沃克科技有限公司

Shenzhen Loowoko Technology Co., Ltd

中國

深圳市龙岗区坂田街道新雪社区

上雪科技城北区 2 号 E 栋厂房四层、五层

[74] HONG KONG DECENT INTELLECTUAL PROPERTY AGENT LIMITED

香港

文咸東街 78 號

華東商業大廈三樓

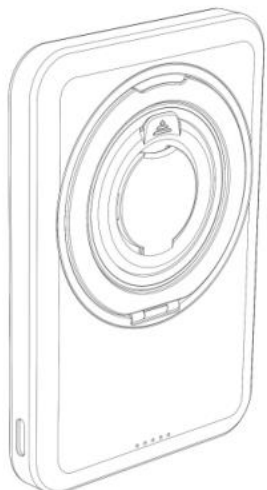

---

[11] 2423516.0

[15] 13-06-2024

[51] Cl. 13-02

[54] 無線充電寶  
Wireless power bank

[73] 深圳市洛沃克科技有限公司  
Shenzhen Loowoko Technology Co., Ltd  
中國  
深圳市龙岗区坂田街道新雪社区  
上雪科技城北区 2 号 E 栋厂房四层、五层

[74] HONG KONG DECENT INTELLECTUAL PROPERTY AGENT LIMITED  
香港  
文咸東街 78 號  
華東商業大廈三樓

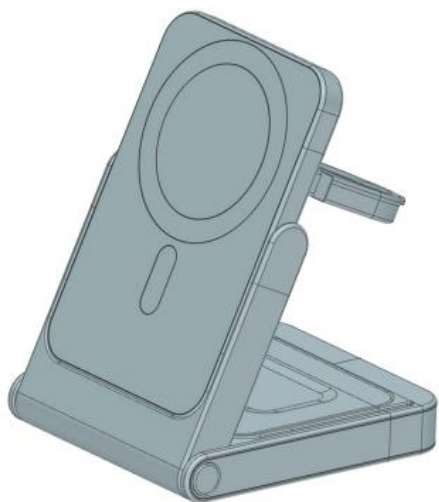

- [11] 2423518.4  
[15] 13-06-2024  
[51] Cl. 26-04  
[54] 照明模組  
Lighting module  
[73] Neonlite Distribution Limited  
Unit 1907, 19/F, Lu Plaza, 2 Wing Yip Street,  
Kwun Tong, Kowloon,  
Hong Kong  
[74] ACCOLADE IP LIMITED  
10/F, Fu Fai Comm. Ctr.,  
27 Hillier Street, Sheung Wan,  
Hong Kong



- 
- [11] 2423519.6M001  
[15] 13-06-2024  
[51] Cl. 23-04  
[54] 空調機  
Air conditioner  
[73] Panasonic Appliances Air-Conditioning Malaysia Sdn. Bhd.  
Lot 2, Persiaran Tengku Ampuan, Section 21,  
Shah Alam Industrial Site,  
40300 Shah Alam, Selangor Darul Ehsan,  
Malaysia  
[74] MARKS & CLERK  
Level 9, Cyberport 1,  
100 Cyberport Road, Pok Fu Lam,  
Hong Kong



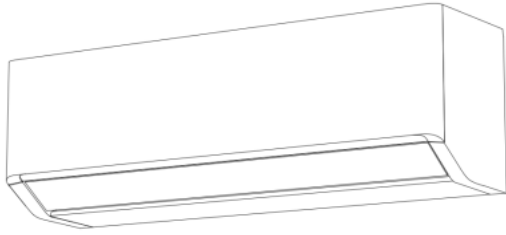

---

[11] 2423519.6M002

[15] 13-06-2024

[51] Cl. 23-04

[54] 空調機

Air conditioner

[73] Panasonic Appliances Air-Conditioning Malaysia Sdn. Bhd.

Lot 2, Persiaran Tengku Ampuan, Section 21,  
Shah Alam Industrial Site,  
40300 Shah Alam, Selangor Darul Ehsan,  
Malaysia

[74] MARKS & CLERK

Level 9, Cyberport 1,  
100 Cyberport Road, Pok Fu Lam,  
Hong Kong

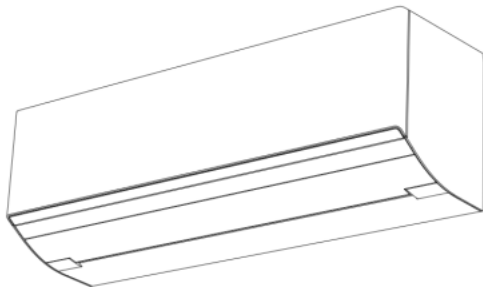

---

[11] 2423520.8M001

[15] 13-06-2024

[51] Cl. 9-03

[54] 包裝盒

Packaging box

[73] 亞倫亞當有限公司

Aaron Adam Limited  
Unit A, 15/F, Block 1, Leader Industrial Centre,  
188-202 Texaco Road, Tsuen Wan,  
Hong Kong

[74] Aaron Adam Limited

Unit A, 15/F, Block 1, Leader Industrial Centre,

188-202 Texaco Road, Tsuen Wan,  
Hong Kong



[11] 2423520.8M002

[15] 13-06-2024

[51] C1. 9-03

[54] 包裝盒

Packaging box

[73] 亞倫亞當有限公司

Aaron Adam Limited

Unit A, 15/F, Block 1, Leader Industrial Centre,  
188-202 Texaco Road, Tsuen Wan,  
Hong Kong

[74] Aaron Adam Limited

Unit A, 15/F, Block 1, Leader Industrial Centre,  
188-202 Texaco Road, Tsuen Wan,  
Hong Kong



[11] 2423520.8M003

[15] 13-06-2024

[51] Cl. 9-03

[54] 包裝盒

Packaging box

[73] 亞倫亞當有限公司

Aaron Adam Limited

Unit A, 15/F, Block 1, Leader Industrial Centre,

188-202 Texaco Road, Tsuen Wan,

Hong Kong

[74] Aaron Adam Limited

Unit A, 15/F, Block 1, Leader Industrial Centre,

188-202 Texaco Road, Tsuen Wan,

Hong Kong



[11] 2423520.8M004

[15] 13-06-2024

[51] Cl. 9-03

[54] 包裝盒

Packaging box

[73] 亞倫亞當有限公司

Aaron Adam Limited

Unit A, 15/F, Block 1, Leader Industrial Centre,

188-202 Texaco Road, Tsuen Wan,

Hong Kong

[74] Aaron Adam Limited

Unit A, 15/F, Block 1, Leader Industrial Centre,

188-202 Texaco Road, Tsuen Wan,  
Hong Kong



[11] 2423520.8M005

[15] 13-06-2024

[51] C1. 9-03

[54] 包裝盒

Packaging box

[73] 亞倫亞當有限公司

Aaron Adam Limited

Unit A, 15/F, Block 1, Leader Industrial Centre,  
188-202 Texaco Road, Tsuen Wan,  
Hong Kong

[74] Aaron Adam Limited

Unit A, 15/F, Block 1, Leader Industrial Centre,  
188-202 Texaco Road, Tsuen Wan,  
Hong Kong



[11] 2423520.8M006

[15] 13-06-2024

[51] Cl. 9-03

[54] 包裝盒

Packaging box

[73] 亞倫亞當有限公司

Aaron Adam Limited

Unit A, 15/F, Block 1, Leader Industrial Centre,

188-202 Texaco Road, Tsuen Wan,

Hong Kong

[74] Aaron Adam Limited

Unit A, 15/F, Block 1, Leader Industrial Centre,

188-202 Texaco Road, Tsuen Wan,

Hong Kong



---

[11] 2423520.8M007

[15] 13-06-2024

[51] Cl. 9-03

[54] 包裝盒

Packaging box

[73] 亞倫亞當有限公司

Aaron Adam Limited

Unit A, 15/F, Block 1, Leader Industrial Centre,

188-202 Texaco Road, Tsuen Wan,

Hong Kong

[74] Aaron Adam Limited

Unit A, 15/F, Block 1, Leader Industrial Centre,

188-202 Texaco Road, Tsuen Wan,  
Hong Kong



[11] 2423520.8M008

[15] 13-06-2024

[51] C1. 9-03

[54] 包裝盒  
Packaging box

[73] 亞倫亞當有限公司  
Aaron Adam Limited  
Unit A, 15/F, Block 1, Leader Industrial Centre,  
188-202 Texaco Road, Tsuen Wan,  
Hong Kong

[74] Aaron Adam Limited  
Unit A, 15/F, Block 1, Leader Industrial Centre,  
188-202 Texaco Road, Tsuen Wan,  
Hong Kong



- [11] 2423526.1  
[15] 14-06-2024  
[30] 13-02-2024 / JP / 2024-003021  
[51] Cl. 20-01  
[54] 售票機  
Tickets vending machine  
[73] 株式會社萬代  
BANDAI CO., LTD.  
4-8, Komagata 1-chome, Taito-ku, Tokyo,  
Japan  
[74] 范紀羅江律師行  
香港  
灣仔港灣道 6-8 號  
瑞安中心 23 樓

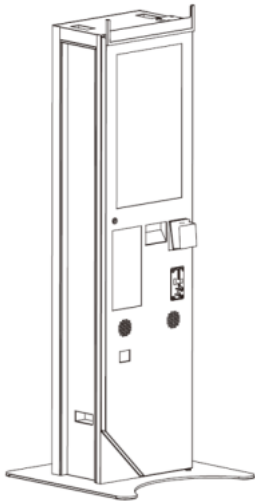

- 
- [11] 2423527.3  
[15] 14-06-2024  
[30] 13-03-2024 / EU / 015053536-0001  
[51] Cl. 3-01  
[54] 袋  
Bag  
[73] Flashbay Electronics Hong Kong Ltd  
Rm A, 26/F, Loong Wan Building,  
8 North Point Road, North Point,  
Hong Kong  
[74] ACCOLADE IP LIMITED  
10/F, Fu Fai Comm. Ctr.,

27 Hillier Street, Sheung Wan,  
Hong Kong

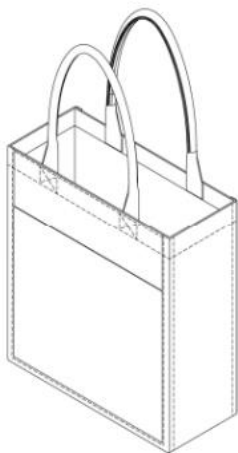

---

[11] 2423528.5M001

[15] 14-06-2024

[30] 13-03-2024 / EU / 015053537-0001

[51] Cl. 21-02

[54] 飛盤

Flying disc

[73] Flashbay Electronics Hong Kong Ltd  
Rm A, 26/F, Loong Wan Building,  
8 North Point Road, North Point,  
Hong Kong

[74] ACCOLADE IP LIMITED  
10/F, Fu Fai Comm. Ctr.,  
27 Hillier Street, Sheung Wan,  
Hong Kong



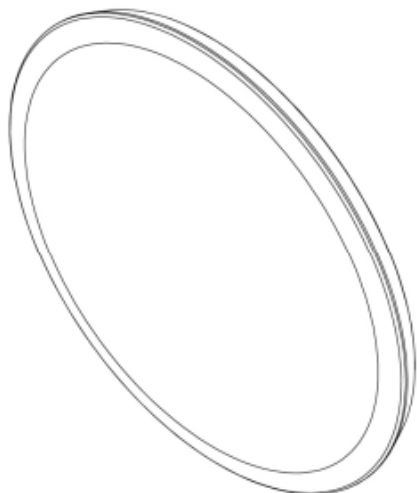

---

[11] 2423528.5M002

[15] 14-06-2024

[30] 13-03-2024 / EU / 015053537-0002

[51] Cl. 21-02

[54] 飛盤

Flying disc

[73] Flashbay Electronics Hong Kong Ltd

Rm A, 26/F, Loong Wan Building,  
8 North Point Road, North Point,  
Hong Kong

[74] ACCOLADE IP LIMITED

10/F, Fu Fai Comm. Ctr.,  
27 Hillier Street, Sheung Wan,  
Hong Kong

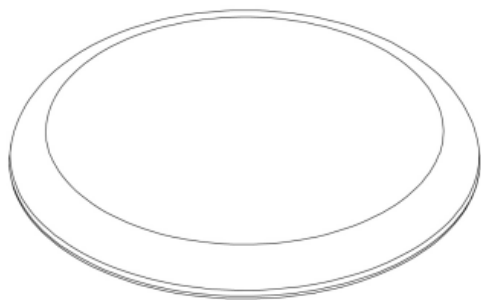

---

[11] 2423529.7

[15] 17-06-2024

[30] 22-12-2023 / CA, MX, OM, SG, CH, TR, GB, VN, EU, IL /  
DM/235704

[51] Cl. 10-02

[54] 錶

Watch

[73] RADO UHREN AG (RADO WATCH CO. LTD.) (MONTRES RADO SA)

Bielstrasse 45,  
CH-2543 Lengnau,  
Switzerland

[74] SPRUSON & FERGUSON (HONG KONG) LIMITED

5001 Hopewell Centre,  
183 Queen's Road East, Wan Chai,  
Hong Kong



[11] 2423530.9

[15] 17-06-2024

[51] Cl. 9-05

[54] 包裝用袋

Packaging bag

[73] 客樂譜株式會社

Kracie, Ltd.  
20-20, Kaigan 3-chome, Minato-ku, Tokyo,  
Japan

[74] UNION PATENT SERVICE CENTRE

Units E-F, 20th Floor, Neich Tower,  
128 Gloucester Road,  
Hong Kong



[11] 2423531.1M001

[15] 17-06-2024

[30] 11-01-2024 / CA, AM, AZ, BZ, BA, GE, LI, MK, MD, MC, MN, ME,  
MA, NO, OM, SG, CH, TN, TR, UA, GB, EU, AL, KG / DM/235904

[51] Cl. 10-07

[54] 錶面  
Dial

[73] OMEGA SA (OMEGA AG) (OMEGA LTD.)  
Jakob-Stämpfli-Strasse 96,  
CH-2502 Biel/Bienne,  
Switzerland

[74] SPRUSON & FERGUSON (HONG KONG) LIMITED  
5001 Hopewell Centre,  
183 Queen's Road East, Wan Chai,  
Hong Kong

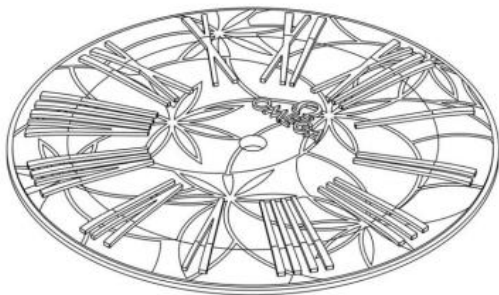

---

[11] 2423531.1M002

[15] 17-06-2024

[30] 11-01-2024 / CA, AM, AZ, BZ, BA, GE, LI, MK, MD, MC, MN, ME,  
MA, NO, OM, SG, CH, TN, TR, UA, GB, EU, AL, KG / DM/235904

[51] Cl. 10-07

[54] 錶面  
Dial

[73] OMEGA SA (OMEGA AG) (OMEGA LTD.)  
Jakob-Stämpfli-Strasse 96,  
CH-2502 Biel/Bienne,  
Switzerland

[74] SPRUSON & FERGUSON (HONG KONG) LIMITED  
5001 Hopewell Centre,  
183 Queen's Road East, Wan Chai,  
Hong Kong

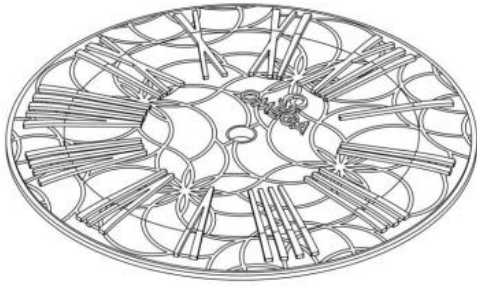

---

[11] 2423531.1M003

[15] 17-06-2024

[30] 11-01-2024 / CA, AM, AZ, BZ, BA, GE, LI, MK, MD, MC, MN, ME, MA, NO, OM, SG, CH, TN, TR, UA, GB, EU, AL, KG / DM/235904

[51] Cl. 10-07

[54] 錶面  
Dial

[73] OMEGA SA (OMEGA AG) (OMEGA LTD.)  
Jakob-Stämpfli-Strasse 96,  
CH-2502 Biel/Bienne,  
Switzerland

[74] SPRUSON & FERGUSON (HONG KONG) LIMITED  
5001 Hopewell Centre,  
183 Queen's Road East, Wan Chai,  
Hong Kong

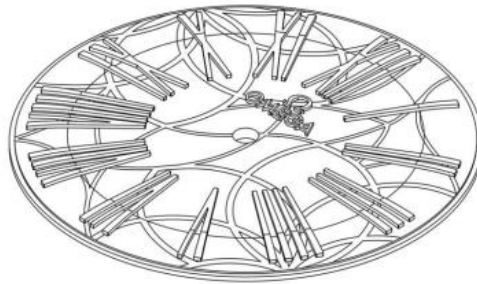

---

[11] 2423531.1M004

[15] 17-06-2024

[30] 11-01-2024 / CA, AM, AZ, BZ, BA, GE, LI, MK, MD, MC, MN, ME, MA, NO, OM, SG, CH, TN, TR, UA, GB, EU, AL, KG / DM/235904

[51] Cl. 10-07

[54] 錶面  
Dial

[73] OMEGA SA (OMEGA AG) (OMEGA LTD.)  
Jakob-Stämpfli-Strasse 96,

CH-2502 Biel/Bienne,  
Switzerland

[74] SPRUSON & FERGUSON (HONG KONG) LIMITED  
5001 Hopewell Centre,  
183 Queen's Road East, Wan Chai,  
Hong Kong

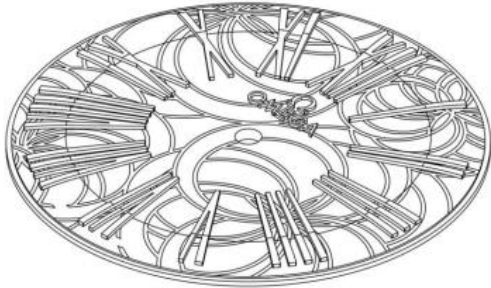

---

[11] 2423531.1M005

[15] 17-06-2024

[30] 11-01-2024 / CA, AM, AZ, BZ, BA, GE, LI, MK, MD, MC, MN, ME,  
MA, NO, OM, SG, CH, TN, TR, UA, GB, EU, AL, KG / DM/235904

[51] Cl. 10-07

[54] 錶面  
Dial

[73] OMEGA SA (OMEGA AG) (OMEGA LTD.)  
Jakob-Stämpfli-Strasse 96,  
CH-2502 Biel/Bienne,  
Switzerland

[74] SPRUSON & FERGUSON (HONG KONG) LIMITED  
5001 Hopewell Centre,  
183 Queen's Road East, Wan Chai,  
Hong Kong

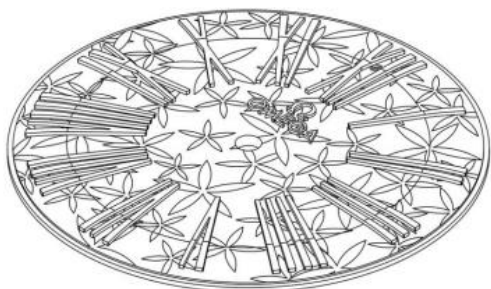



香港特別行政區政府知識產權署外觀設計註冊處

The Government of the Hong Kong Special Administrative Region

Designs Registry, Intellectual Property Department

根據註冊外觀設計條例第 28 條，下列註冊外觀設計因未繳續期費而停止有效。

各組記項按註冊外觀設計停止有效日期及註冊編號先後次序排列。

**Registered designs ceased through non-payment of renewal fees under section 28 of the Registered Designs Ordinance. Entries are listed below under their expiry dates.**

**20-06-2024 - 26-06-2024****20-06-2024**

0411371.2

1401163.1

1914044.9

1914046.4M001

1914046.4M002

1914046.4M003

1914046.4M004

1914046.4M005

1914046.4M006

1914046.4M007

1914046.4M008

1914046.4M009

1914046.4M010

1914076.7

1914077.9

**25-06-2024**

0411408.2

1401193.4M001

1401193.4M002

1401193.4M003

1401193.4M004

1401193.4M005

1401193.4M006

1401197.3

1401198.5

1401199.7

1401200.1

1401201.3

1401202.5

**22-06-2024**

1401165.6

1401166.8

1401170.6

1401171.8

1401172.0

**26-06-2024**

1401209.0M001

1401209.0M002

1401209.0M003

1401209.0M005

1401209.0M007

1401210.2M001

1401210.2M002

1914087.0

1914088.2

**23-06-2024**

0411392.6M002

1914048.8M002

1914049.0

**24-06-2024**

1401188.4

1401191.0

1914066.6

1914068.0

1914069.2

1914075.5

1914091.8M001

1914091.8M002



香港特別行政區政府知識產權署外觀設計註冊處

The Government of the Hong Kong Special Administrative Region

Designs Registry, Intellectual Property Department

根據註冊外觀設計規則第 31 條刪除的註冊外觀設計。各組記項按註冊外觀設計刪除日期及註冊編號先後次序排列。

**Registered designs removed under section 31 of the Registered Designs Rules. Entries are listed below under their removal dates.**

**28-06-2024 - 04-07-2024**

**28-06-2024**

1802518.1M001

1802518.1M002

1802521.7

1802527.0

1802528.2

1802530.6

1802531.8

**30-06-2024**

0803035.5

1302294.8

**01-07-2024**

0312266.0

1302306.6M001

1302306.6M002

1302306.6M003

1302306.6M004

1302306.6M005

1302306.6M006

**04-07-2024**

1302310.4

1302313.0

1802544.5

1802548.4

1802549.6

1802550.8

1802554.6

1802555.9



香港特別行政區政府知識產權署外觀設計註冊處

The Government of the Hong Kong Special Administrative Region

Designs Registry, Intellectual Property Department

## 根據註冊外觀設計條例第 76 條，更正已提交文件中的錯誤

### Correction of errors in filed documents under section 76 of the Registered Designs Ordinance

下列在 10.05.2024 官方公報刊登的更正錯誤的請求已在 11.07.2024 獲准許

The following request for correction of error advertised in the official journal on 10.05.2024 was allowed on 11.07.2024

[21] 2321901.3

[71] 東保集團有限公司

Tunbow Group Limited

[21] 2321732.4

[55] 外觀設計的表述

Representations of the Design

[21] 2321733.6

[71] 外觀設計的表述

Representations of the Design