

# 香港知識產權公報

Hong Kong Intellectual Property Journal

2024年3月22日

22 March 2024



## 目錄 Contents

### 根據註冊外觀設計條例第 25 條註冊的外觀設計

#### **Designs Registered under section 25 of the Registered Designs Ordinance**

按註冊編號排列

Arranged by Registration Number

### 根據註冊外觀設計條例(第 522 章)公布的其他公告

#### **Other Notices Published under the Registered Designs Ordinance (Cap. 522)**

根據註冊外觀設計條例第 28 條，註冊外觀設計因未繳續期費而停止有效

Registered designs ceased through non-payment of renewal fees under section 28 of the Registered Designs Ordinance

根據註冊外觀設計規則第 31 條刪除的註冊外觀設計

Registered designs removed under section 31 of the Registered Designs Rules

根據註冊外觀設計條例第 76 條，更正已提交文件中的錯誤

Correction of errors in filed documents under section 76 of the Registered Designs Ordinance

### 以下事項沒有記錄

#### **No Records for the Following Matters**

根據註冊外觀設計條例第 30 條放棄的外觀設計的註冊

Surrender of Registration of Design under section 30 of the Registered Designs Ordinance

根據註冊外觀設計規則第 37 條，向處長作出轉介

Reference to Registrar under section 37 of the Registered Designs Rules

根據註冊外觀設計條例第 45 條，撤銷註冊

Revocation of Registration under section 45 of the Registered Designs Ordinance

根據註冊外觀設計規則第 46 條，向法院作出轉介

Reference to Court under section 46 of the Registered Designs Rules

根據註冊外觀設計規則第 63 條對不符合規定之處作出糾正

Rectification of Irregularities under section 63 of the Registered Designs Rules

根據註冊外觀設計條例第 66 條，糾正註冊紀錄冊

Rectification of Register under section 66 of the Registered Designs Ordinance

根據註冊外觀設計條例第 67 條 更正註冊紀錄冊內的錯誤

Correction of errors in Register under section 67 of the Registered Designs Ordinance

根據註冊外觀設計條例第 67 及 76 條，更正註冊紀錄冊內及已提交文件中的錯誤

Correction of Errors in Register and in Filed Documents under sections 67 and 76 of the Registered Designs Ordinance

勘誤

Corrigendum

## 註冊外觀設計公告註釋

### Notes on advertisements of registration of designs

方括號表示下列資料：

Square brackets indicate the following data：

[11] 註冊編號 Registration number / 聯合王國註冊編號 United Kingdom registration number

[15] 註冊日期 Registration date / 當作註冊日期 Deemed registration date / 聯合王國註冊日期 United Kingdom registration date

[17] 註冊有效期屆滿日期 Expiry date of the period of registration

[22] 提交日期 Filing date / 當作提交日期 Deemed filing date / 聯合王國提交日期 United Kingdom filing date

[30] 聲稱享有的優先權（提交日期 / 巴黎公約國或世界貿易組織成員 / 申請編號） Priority claimed (filing date / Paris Convention country or WTO member / application number)

[51] 國際外觀設計分類號（洛迦諾分類號） International Classification of designs (Locarno Classification)

[54] 物品 Article

[55] 外觀設計的表述 Representation of the design

[62] 分開前的申請編號及提交日期 Application number before division and filing date

[66] 過往註冊的聯繫外觀設計註冊編號 / 日期 Registration No. / Date of Previous Registration for Association

[72] 設計人 Designer

[73] 擁有人姓名和地址 Name and address of the owner

[74] 代理人 Agent /送達地址 Address for service



香港特別行政區政府知識產權署外觀設計註冊處  
The Government of the Hong Kong Special Administrative Region  
Designs Registry, Intellectual Property Department

## 根據註冊外觀設計條例第 25 條註冊的外觀設計

### Designs registered under section 25 of the Registered Designs Ordinance

按註冊編號排列

Arranged by Registration Number

- [11] 2220668.6
- [15] 04-11-2022
- [30] 06-05-2022 / DE / 40 2022 100 383.8
- [51] Cl. 21-01
- [54] 玩具或比例模型車  
Toy or scale model vehicle
- [73] Bayerische Motoren Werke Aktiengesellschaft  
Petuelring 130,  
80809 Muenchen,  
Germany
- [74] HASTINGS & CO  
5/F, Gloucester Tower, The Landmark,  
11 Pedder Street,  
Central, Hong Kong



- 
- [11] 2321878.3
  - [15] 14-08-2023
  - [30] 13-02-2023 / EU / 015011278
  - [51] Cl. 9-03
  - [54] 用於包裝上的標識、裝飾、圖形符號、標籤、平面設計或表面圖案  
Logo, ornamentation, graphic symbol, label, graphic design or  
surface pattern for packaging boxes
  - [73] Norwex Malta Ltd.  
Pama Flat Nru 1, Misrah ls-Sebbieh, Zebbiegh,

L-Imgarr MGR 2071,  
Malta

- [74] CHAN, TANG & KWOK  
Rooms 2503-4, 25/F,  
Shanghai Industrial Investment Building,  
48-62 Hennessy Road, Wanchai, Hong Kong



- 
- [11] 2322359.3  
[15] 17-11-2023  
[51] Cl. 24-01  
[54] 光能儀  
Device for optical energy  
[73] 新元科技(亞洲)有限公司  
New Age Technology (Asia) Limited  
香港新界荃灣  
海盛路3號  
TML 廣場 32 樓 A1-A5 室  
[74] 弘研知識產權有限公司  
香港荃灣  
海盛路3號  
TML 大廈 16 樓 A5 室

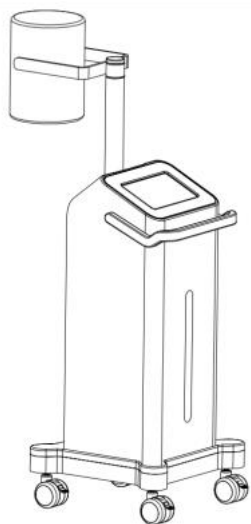

---

[11] 2322398.5

[15] 22-11-2023

[30] 22-05-2023 / FR / 20232363

[51] Cl. 3-01

[54] 袋

Bag

[73] LOUIS VUITTON MALLETIER

2 rue du Pont-Neuf,

75001 Paris,

France

[74] BAKER & MCKENZIE

14th Floor, One Taikoo Place,

979 King's Road,

Quarry Bay, Hong Kong





- [11] 2322399.7  
[15] 22-11-2023  
[30] 19-06-2023 / FR / 20232793  
[51] Cl. 8-07  
[54] 扣  
Clasp  
[73] LOUIS VUITTON MALLETIER  
2 rue du Pont-Neuf,  
75001 Paris,  
France  
[74] BAKER & MCKENZIE  
14th Floor, One Taikoo Place,  
979 King's Road,  
Quarry Bay, Hong Kong

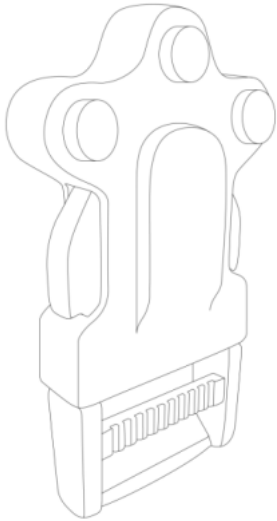

- 
- [11] 2322404.9  
[15] 22-11-2023  
[30] 20-06-2023 / FR / 20232797  
[51] Cl. 3-01  
[54] 行李箱  
Luggage  
[73] LOUIS VUITTON MALLETIER  
2 rue du Pont-Neuf,  
75001 Paris,  
France  
[74] BAKER & MCKENZIE  
14th Floor, One Taikoo Place,  
979 King's Road,  
Quarry Bay, Hong Kong

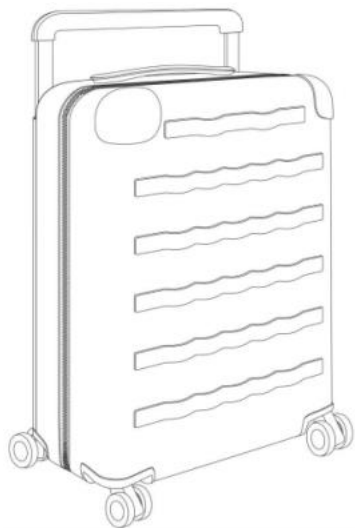

[11] 2322439.3

[15] 29-11-2023

[30] 30-06-2023 / CN / 202330409404.6

[51] C1. 13-03

[54] 轉換器

Converter

[73] 公牛集團股份有限公司

Goneo Group Co., Ltd.

中國

浙江省寧波市慈溪市

觀海衛鎮工業園東區，315315

[74] 百睿知識產權有限公司

香港新界沙田

香港科學園

科技大道西 10 號浚湖樓 617 室

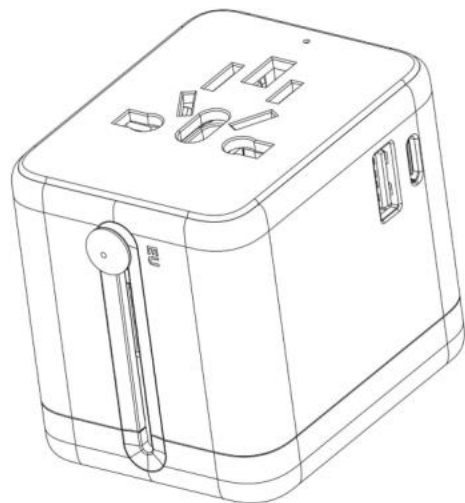

[11] 2322492.4M001

[15] 04-12-2023

[30] 04-06-2023 / US / 29/877,241

[51] Cl. 14-04

[54] 用於顯示屏或其一部分的圖形用戶界面

Graphical user interface for display or portion thereof

[73] 蘋果公司

APPLE INC.

One Apple Park Way Cupertino,

California 95014,

United States of America

[74] BARRON & YOUNG INTELLECTUAL PROPERTY LIMITED

Suite 617, Lakeside 2,

No. 10 Science Park West Avenue,

Hong Kong Science Park, Shatin,

New Territories, Hong Kong

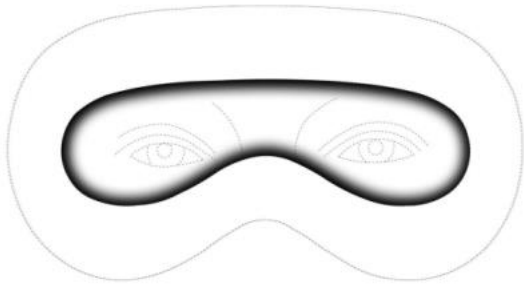

---

[11] 2322492.4M002

[15] 04-12-2023

[30] 04-06-2023 / US / 29/877,241

[51] Cl. 14-04

[54] 用於顯示屏或其一部分的圖形用戶界面

Graphical user interface for display or portion thereof

[73] 蘋果公司

APPLE INC.

One Apple Park Way Cupertino,

California 95014,

United States of America

[74] BARRON & YOUNG INTELLECTUAL PROPERTY LIMITED

Suite 617, Lakeside 2,

No. 10 Science Park West Avenue,

Hong Kong Science Park, Shatin,

New Territories, Hong Kong

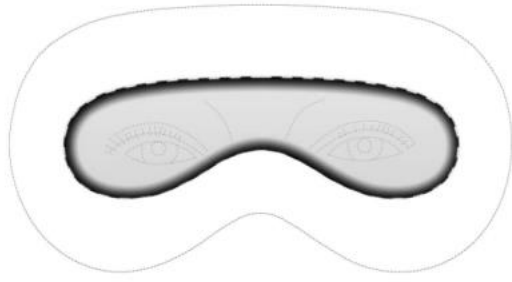

---

[11] 2322492.4M003

[15] 04-12-2023

[30] 04-06-2023 / US / 29/877,241

[51] Cl. 14-04

[54] 用於顯示屏或其一部分的動態圖形用戶界面

Animated graphical user interface for display or portion thereof

[73] 蘋果公司

APPLE INC.

One Apple Park Way Cupertino,  
California 95014,  
United States of America

[74] BARRON & YOUNG INTELLECTUAL PROPERTY LIMITED

Suite 617, Lakeside 2,  
No. 10 Science Park West Avenue,  
Hong Kong Science Park, Shatin,  
New Territories, Hong Kong



---

[11] 2322494.8M001

[15] 04-12-2023

[30] 04-06-2023 / US / 29/877,243

[51] Cl. 14-04

[54] 用於電腦顯示系統或其一部分的具有三維外觀的圖形用戶界面

Graphical user interface having a three dimensional appearance for computer display system or portion thereof

[73] 蘋果公司

APPLE INC.

One Apple Park Way Cupertino,

California 95014,

United States of America

[74] BARRON & YOUNG INTELLECTUAL PROPERTY LIMITED

Suite 617, Lakeside 2,

No. 10 Science Park West Avenue,

Hong Kong Science Park, Shatin,

New Territories, Hong Kong

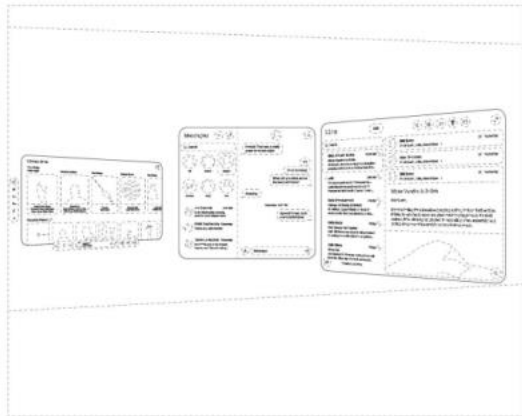

---

[11] 2322494.8M002

[15] 04-12-2023

[30] 04-06-2023 / US / 29/877,243

[51] Cl. 14-04

[54] 用於電腦顯示系統或其一部分的具有三維外觀的動態圖形用戶介面

Animated graphical user interface having a three dimensional appearance for computer display system or portion thereof

[73] 蘋果公司

APPLE INC.

One Apple Park Way Cupertino,

California 95014,

United States of America

[74] BARRON & YOUNG INTELLECTUAL PROPERTY LIMITED

Suite 617, Lakeside 2,

No. 10 Science Park West Avenue,

Hong Kong Science Park, Shatin,

New Territories, Hong Kong

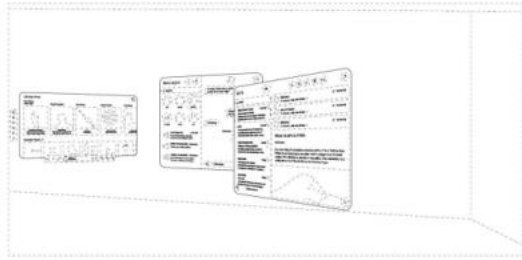

[11] 2322494.8M003

[15] 04-12-2023

[30] 04-06-2023 / US / 29/877,243

[51] Cl. 14-04

[54] 用於電腦顯示系統或其一部分的具有三維外觀的動態圖形用戶介面  
Animated graphical user interface having a three dimensional appearance for computer display system or portion thereof

[73] 蘋果公司  
APPLE INC.  
One Apple Park Way Cupertino,  
California 95014,  
United States of America

[74] BARRON & YOUNG INTELLECTUAL PROPERTY LIMITED  
Suite 617, Lakeside 2,  
No. 10 Science Park West Avenue,  
Hong Kong Science Park, Shatin,  
New Territories, Hong Kong

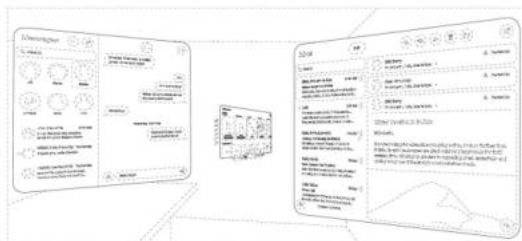

[11] 2322494.8M004

[15] 04-12-2023

[30] 04-06-2023 / US / 29/877,243

[51] Cl. 14-04

[54] 用於電腦顯示系統或其一部分的具有三維外觀的動態圖形用戶介面  
Animated graphical user interface having a three dimensional appearance for computer display system or portion thereof

[73] 蘋果公司  
APPLE INC.  
One Apple Park Way Cupertino,

California 95014,  
United States of America

[74] BARRON & YOUNG INTELLECTUAL PROPERTY LIMITED  
Suite 617, Lakeside 2,  
No. 10 Science Park West Avenue,  
Hong Kong Science Park, Shatin,  
New Territories, Hong Kong

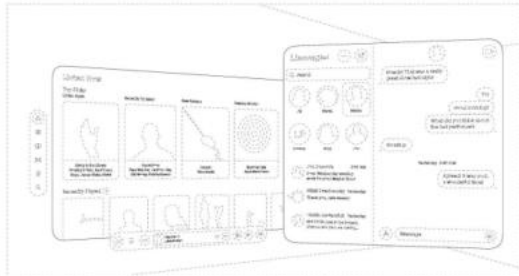

[11] 2322494.8M005

[15] 04-12-2023

[30] 04-06-2023 / US / 29/877,243

[51] Cl. 14-04

[54] 用於電腦顯示系統或其一部分的具有三維外觀的動態圖形用戶介面  
Animated graphical user interface having a three dimensional  
appearance for computer display system or portion thereof

[73] 蘋果公司  
APPLE INC.  
One Apple Park Way Cupertino,  
California 95014,  
United States of America

[74] BARRON & YOUNG INTELLECTUAL PROPERTY LIMITED  
Suite 617, Lakeside 2,  
No. 10 Science Park West Avenue,  
Hong Kong Science Park, Shatin,  
New Territories, Hong Kong

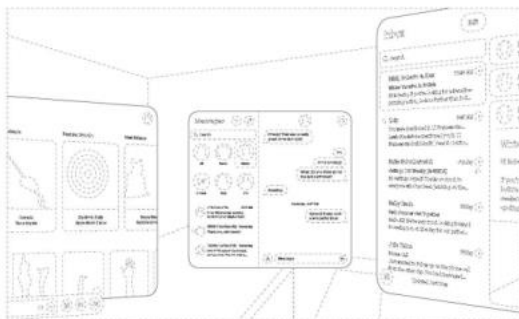

[11] 2322494.8M006

[15] 04-12-2023

[30] 04-06-2023 / US / 29/877,243

[51] Cl. 14-04

[54] 用於電腦顯示系統或其一部分的具有三維外觀的動態圖形用戶介面  
Animated graphical user interface having a three dimensional appearance for computer display system or portion thereof

[73] 蘋果公司  
APPLE INC.  
One Apple Park Way Cupertino,  
California 95014,  
United States of America

[74] BARRON & YOUNG INTELLECTUAL PROPERTY LIMITED  
Suite 617, Lakeside 2,  
No. 10 Science Park West Avenue,  
Hong Kong Science Park, Shatin,  
New Territories, Hong Kong

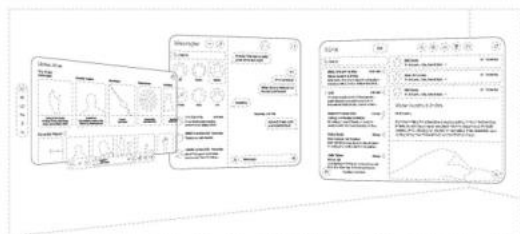

---

[11] 2322494.8M007

[15] 04-12-2023

[30] 04-06-2023 / US / 29/877,243

[51] Cl. 14-04

[54] 用於電腦顯示系統或其一部分的具有三維外觀的動態圖形用戶介面  
Animated graphical user interface having a three dimensional appearance for computer display system or portion thereof

[73] 蘋果公司  
APPLE INC.  
One Apple Park Way Cupertino,  
California 95014,  
United States of America

[74] BARRON & YOUNG INTELLECTUAL PROPERTY LIMITED  
Suite 617, Lakeside 2,  
No. 10 Science Park West Avenue,  
Hong Kong Science Park, Shatin,  
New Territories, Hong Kong



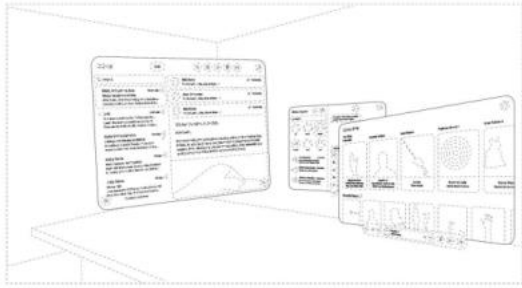

[11] 2322494.8M008

[15] 04-12-2023

[30] 04-06-2023 / US / 29/877,243

[51] Cl. 14-04

[54] 用於電腦顯示系統或其一部分的具有三維外觀的動態圖形用戶介面  
Animated graphical user interface having a three dimensional appearance for computer display system or portion thereof

[73] 蘋果公司

APPLE INC.

One Apple Park Way Cupertino,

California 95014,

United States of America

[74] BARRON & YOUNG INTELLECTUAL PROPERTY LIMITED

Suite 617, Lakeside 2,

No. 10 Science Park West Avenue,

Hong Kong Science Park, Shatin,

New Territories, Hong Kong

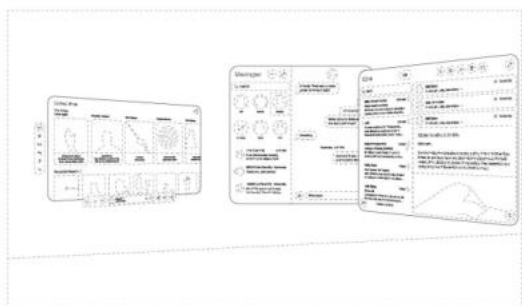

[11] 2322494.8M009

[15] 04-12-2023

[30] 04-06-2023 / US / 29/877,243

[51] Cl. 14-04

[54] 用於電腦顯示系統或其一部分的具有三維外觀的動態圖形用戶介面  
Animated graphical user interface having a three dimensional appearance for computer display system or portion thereof

[73] 蘋果公司

APPLE INC.

One Apple Park Way Cupertino,  
California 95014,  
United States of America

[74] BARRON & YOUNG INTELLECTUAL PROPERTY LIMITED

Suite 617, Lakeside 2,  
No. 10 Science Park West Avenue,  
Hong Kong Science Park, Shatin,  
New Territories, Hong Kong

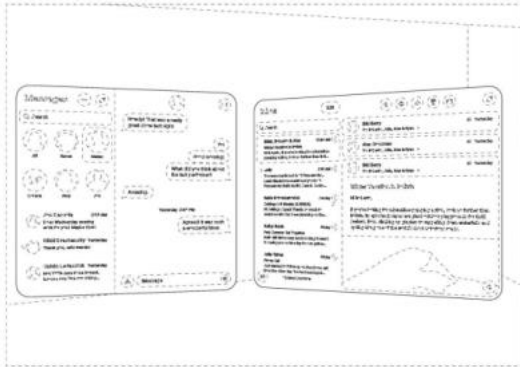

[11] 2322494.8M010

[15] 04-12-2023

[30] 04-06-2023 / US / 29/877,243

[51] C1. 14-04

[54] 用於電腦顯示系統或其一部分的具有三維外觀的圖形用戶介面

Graphical user interface having a three dimensional appearance  
for computer display system or portion thereof

[73] 蘋果公司

APPLE INC.

One Apple Park Way Cupertino,  
California 95014,  
United States of America

[74] BARRON & YOUNG INTELLECTUAL PROPERTY LIMITED

Suite 617, Lakeside 2,  
No. 10 Science Park West Avenue,  
Hong Kong Science Park, Shatin,  
New Territories, Hong Kong

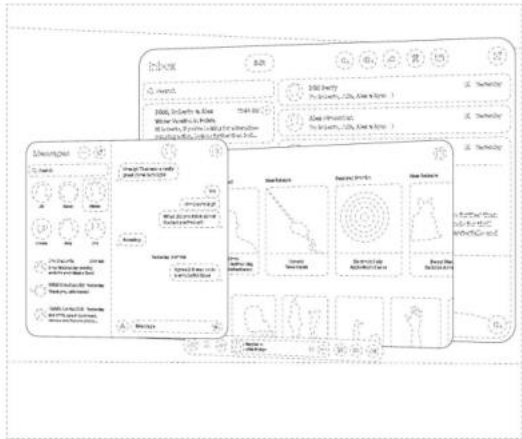

[11] 2322494.8M011

[15] 04-12-2023

[30] 04-06-2023 / US / 29/877,243

[51] C1. 14-04

[54] 用於電腦顯示系統或其一部分的具有三維外觀的圖形用戶介面  
Graphical user interface having a three dimensional appearance  
for computer display system or portion thereof

[73] 蘋果公司  
APPLE INC.  
One Apple Park Way Cupertino,  
California 95014,  
United States of America

[74] BARRON & YOUNG INTELLECTUAL PROPERTY LIMITED  
Suite 617, Lakeside 2,  
No. 10 Science Park West Avenue,  
Hong Kong Science Park, Shatin,  
New Territories, Hong Kong

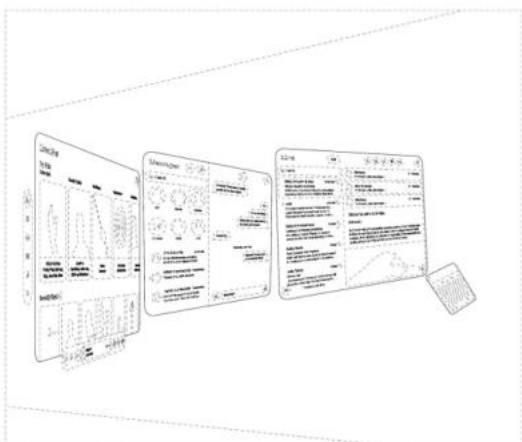

[11] 2322494.8M012

[15] 04-12-2023

[30] 04-06-2023 / US / 29/877,243

[51] Cl. 14-04

[54] 用於電腦顯示系統或其一部分的具有三維外觀的圖形用戶介面

Graphical user interface having a three dimensional appearance for computer display system or portion thereof

[73] 蘋果公司

APPLE INC.

One Apple Park Way Cupertino,  
California 95014,  
United States of America

[74] BARRON & YOUNG INTELLECTUAL PROPERTY LIMITED

Suite 617, Lakeside 2,  
No. 10 Science Park West Avenue,  
Hong Kong Science Park, Shatin,  
New Territories, Hong Kong

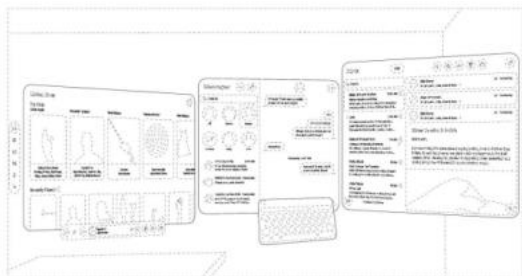

[11] 2322494.8M013

[15] 04-12-2023

[30] 04-06-2023 / US / 29/877,243

[51] Cl. 14-04

[54] 用於電腦顯示系統或其一部分的具有三維外觀的圖形用戶介面

Graphical user interface having a three dimensional appearance for computer display system or portion thereof

[73] 蘋果公司

APPLE INC.

One Apple Park Way Cupertino,  
California 95014,  
United States of America

[74] BARRON & YOUNG INTELLECTUAL PROPERTY LIMITED

Suite 617, Lakeside 2,  
No. 10 Science Park West Avenue,  
Hong Kong Science Park, Shatin,  
New Territories, Hong Kong

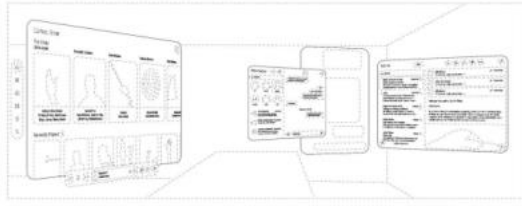

[11] 2322494.8M014

[15] 04-12-2023

[30] 04-06-2023 / US / 29/877,243

[51] Cl. 14-04

[54] 用於電腦顯示系統或其一部分的具有三維外觀的動態圖形用戶介面  
Animated graphical user interface having a three dimensional appearance for computer display system or portion thereof

[73] 蘋果公司  
APPLE INC.  
One Apple Park Way Cupertino,  
California 95014,  
United States of America

[74] BARRON & YOUNG INTELLECTUAL PROPERTY LIMITED  
Suite 617, Lakeside 2,  
No. 10 Science Park West Avenue,  
Hong Kong Science Park, Shatin,  
New Territories, Hong Kong

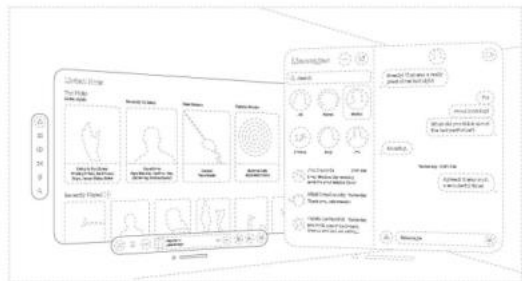

[11] 2322494.8M015

[15] 04-12-2023

[30] 04-06-2023 / US / 29/877,243

[51] Cl. 14-04

[54] 用於電腦顯示系統或其一部分的具有三維外觀的動態圖形用戶介面  
Animated graphical user interface having a three dimensional appearance for computer display system or portion thereof

[73] 蘋果公司  
APPLE INC.  
One Apple Park Way Cupertino,

California 95014,  
United States of America

- [74] BARRON & YOUNG INTELLECTUAL PROPERTY LIMITED  
Suite 617, Lakeside 2,  
No. 10 Science Park West Avenue,  
Hong Kong Science Park, Shatin,  
New Territories, Hong Kong

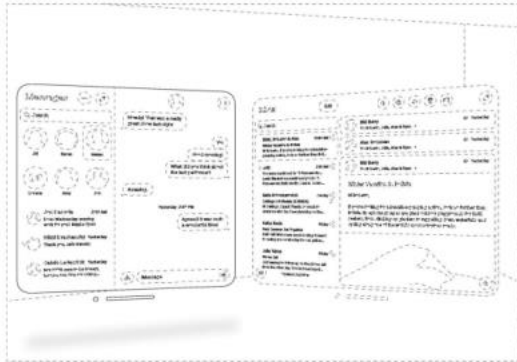

- 
- [11] 2322494.8M016  
[15] 04-12-2023  
[30] 04-06-2023 / US / 29/877,243  
[51] Cl. 14-04  
[54] 用於電腦顯示系統或其一部分的具有三維外觀的圖形用戶介面  
Graphical user interface having a three dimensional appearance  
for computer display system or portion thereof  
[73] 蘋果公司  
APPLE INC.  
One Apple Park Way Cupertino,  
California 95014,  
United States of America  
[74] BARRON & YOUNG INTELLECTUAL PROPERTY LIMITED  
Suite 617, Lakeside 2,  
No. 10 Science Park West Avenue,  
Hong Kong Science Park, Shatin,  
New Territories, Hong Kong

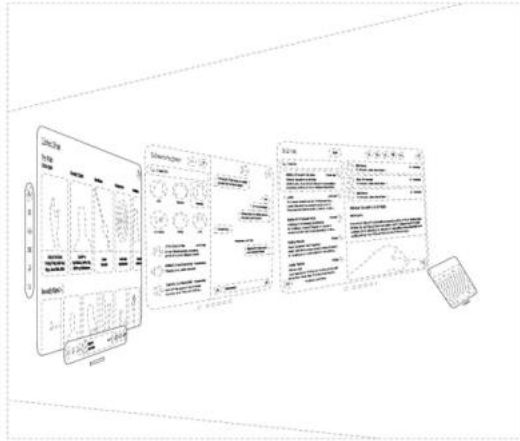

[11] 2322494.8M017

[15] 04-12-2023

[30] 04-06-2023 / US / 29/877,243

[51] Cl. 14-04

[54] 用於電腦顯示系統或其一部分的具有三維外觀的圖形用戶介面  
Graphical user interface having a three dimensional appearance  
for computer display system or portion thereof

[73] 蘋果公司

APPLE INC.

One Apple Park Way Cupertino,  
California 95014,  
United States of America

[74] BARRON & YOUNG INTELLECTUAL PROPERTY LIMITED

Suite 617, Lakeside 2,  
No. 10 Science Park West Avenue,  
Hong Kong Science Park, Shatin,  
New Territories, Hong Kong

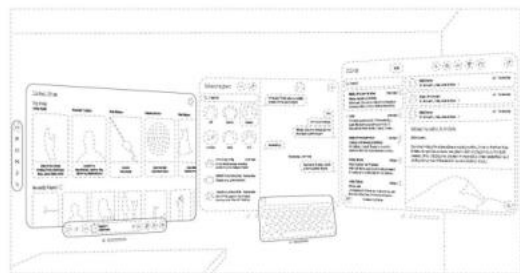

[11] 2322494.8M018

[15] 04-12-2023

[30] 04-06-2023 / US / 29/877,243

[51] Cl. 14-04

[54] 用於電腦顯示系統或其一部分的具有三維外觀的動態圖形用戶介面  
Animated graphical user interface having a three dimensional appearance for computer display system or portion thereof

[73] 蘋果公司  
APPLE INC.  
One Apple Park Way Cupertino,  
California 95014,  
United States of America

[74] BARRON & YOUNG INTELLECTUAL PROPERTY LIMITED  
Suite 617, Lakeside 2,  
No. 10 Science Park West Avenue,  
Hong Kong Science Park, Shatin,  
New Territories, Hong Kong

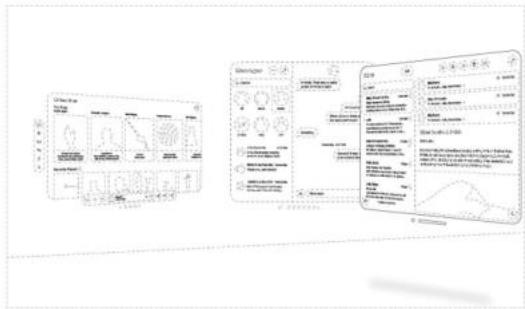

---

[11] 2322494.8M019

[15] 04-12-2023

[30] 04-06-2023 / US / 29/877,243

[51] Cl. 14-04

[54] 用於電腦顯示系統或其一部分的具有三維外觀的圖形用戶介面  
Graphical user interface having a three dimensional appearance for computer display system or portion thereof

[73] 蘋果公司  
APPLE INC.  
One Apple Park Way Cupertino,  
California 95014,  
United States of America

[74] BARRON & YOUNG INTELLECTUAL PROPERTY LIMITED  
Suite 617, Lakeside 2,  
No. 10 Science Park West Avenue,  
Hong Kong Science Park, Shatin,  
New Territories, Hong Kong



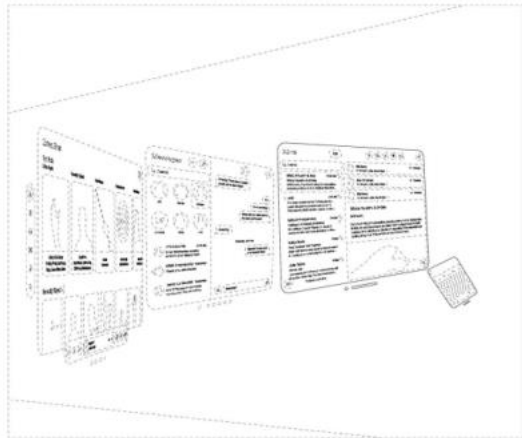

[11] 2322494.8M020

[15] 04-12-2023

[30] 04-06-2023 / US / 29/877,243

[51] Cl. 14-04

[54] 用於電腦顯示系統或其一部分的具有三維外觀的圖形用戶介面

Graphical user interface having a three dimensional appearance for computer display system or portion thereof

[73] 蘋果公司

APPLE INC.

One Apple Park Way Cupertino,  
California 95014,  
United States of America

[74] BARRON & YOUNG INTELLECTUAL PROPERTY LIMITED

Suite 617, Lakeside 2,  
No. 10 Science Park West Avenue,  
Hong Kong Science Park, Shatin,  
New Territories, Hong Kong

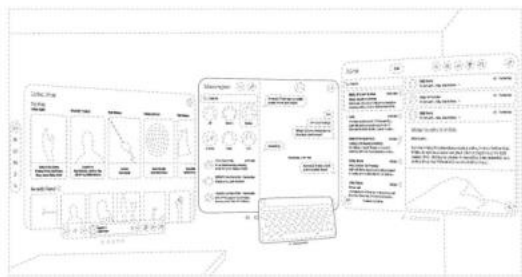

[11] 2322494.8M021

[15] 04-12-2023

[30] 04-06-2023 / US / 29/877,243

[51] Cl. 14-04

[54] 用於電腦顯示系統或其一部分的具有三維外觀的動態圖形用戶介面  
Animated graphical user interface having a three dimensional appearance for computer display system or portion thereof

[73] 蘋果公司  
APPLE INC.  
One Apple Park Way Cupertino,  
California 95014,  
United States of America

[74] BARRON & YOUNG INTELLECTUAL PROPERTY LIMITED  
Suite 617, Lakeside 2,  
No. 10 Science Park West Avenue,  
Hong Kong Science Park, Shatin,  
New Territories, Hong Kong

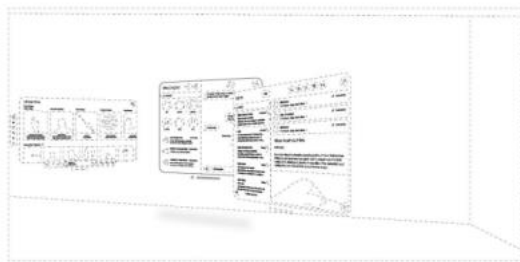

[11] 2322494.8M022

[15] 04-12-2023

[30] 04-06-2023 / US / 29/877,243

[51] Cl. 14-04

[54] 用於電腦顯示系統或其一部分的具有三維外觀的動態圖形用戶介面  
Animated graphical user interface having a three dimensional appearance for computer display system or portion thereof

[73] 蘋果公司  
APPLE INC.  
One Apple Park Way Cupertino,  
California 95014,  
United States of America

[74] BARRON & YOUNG INTELLECTUAL PROPERTY LIMITED  
Suite 617, Lakeside 2,  
No. 10 Science Park West Avenue,  
Hong Kong Science Park, Shatin,  
New Territories, Hong Kong

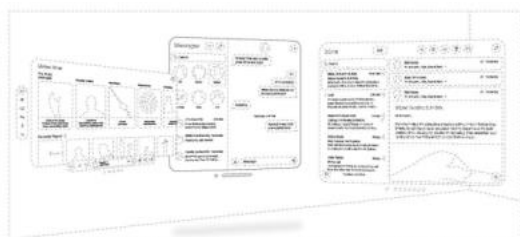

[11] 2322494.8M023

[15] 04-12-2023

[30] 04-06-2023 / US / 29/877,243

[51] Cl. 14-04

[54] 用於電腦顯示系統或其一部分的具有三維外觀的動態圖形用戶介面  
Animated graphical user interface having a three dimensional appearance for computer display system or portion thereof

[73] 蘋果公司

APPLE INC.

One Apple Park Way Cupertino,  
California 95014,  
United States of America

[74] BARRON & YOUNG INTELLECTUAL PROPERTY LIMITED

Suite 617, Lakeside 2,  
No. 10 Science Park West Avenue,  
Hong Kong Science Park, Shatin,  
New Territories, Hong Kong

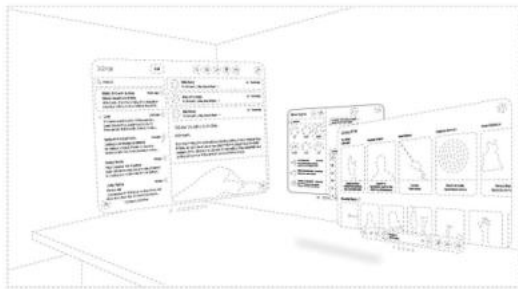

---

[11] 2322494.8M024

[15] 04-12-2023

[30] 04-06-2023 / US / 29/877,243

[51] Cl. 14-04

[54] 用於電腦顯示系統或其一部分的具有三維外觀的圖形用戶介面  
Graphical user interface having a three dimensional appearance for computer display system or portion thereof

[73] 蘋果公司

APPLE INC.

One Apple Park Way Cupertino,  
California 95014,  
United States of America

[74] BARRON & YOUNG INTELLECTUAL PROPERTY LIMITED

Suite 617, Lakeside 2,  
No. 10 Science Park West Avenue,  
Hong Kong Science Park, Shatin,  
New Territories, Hong Kong

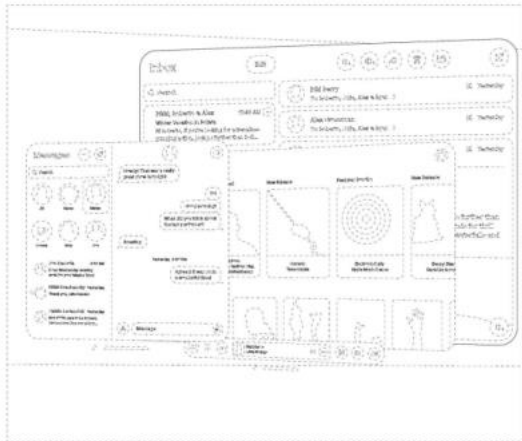

[11] 2322494.8M025

[15] 04-12-2023

[30] 04-06-2023 / US / 29/877,243

[51] C1. 14-04

[54] 用於電腦顯示系統或其一部分的具有三維外觀的圖形用戶介面  
Graphical user interface having a three dimensional appearance  
for computer display system or portion thereof

[73] 蘋果公司  
APPLE INC.  
One Apple Park Way Cupertino,  
California 95014,  
United States of America

[74] BARRON & YOUNG INTELLECTUAL PROPERTY LIMITED  
Suite 617, Lakeside 2,  
No. 10 Science Park West Avenue,  
Hong Kong Science Park, Shatin,  
New Territories, Hong Kong

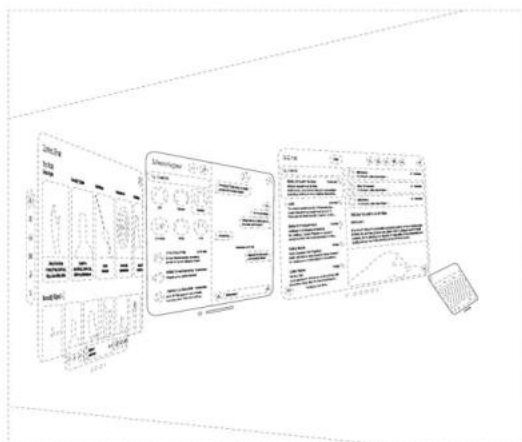

- [11] 2322494.8M026
- [15] 04-12-2023
- [30] 04-06-2023 / US / 29/877,243
- [51] Cl. 14-04
- [54] 用於電腦顯示系統或其一部分的具有三維外觀的圖形用戶介面  
Graphical user interface having a three dimensional appearance for computer display system or portion thereof
- [73] 蘋果公司  
APPLE INC.  
One Apple Park Way Cupertino,  
California 95014,  
United States of America
- [74] BARRON & YOUNG INTELLECTUAL PROPERTY LIMITED  
Suite 617, Lakeside 2,  
No. 10 Science Park West Avenue,  
Hong Kong Science Park, Shatin,  
New Territories, Hong Kong

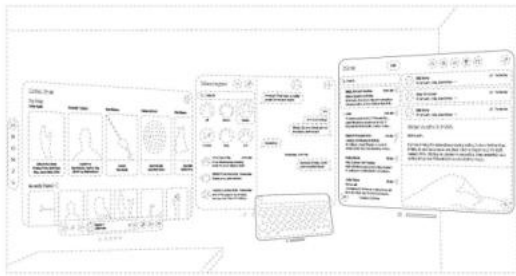

- 
- [11] 2322494.8M027
- [15] 04-12-2023
- [30] 04-06-2023 / US / 29/877,243
- [51] Cl. 14-04
- [54] 用於電腦顯示系統或其一部分的具有三維外觀的動態圖形用戶介面  
Animated graphical user interface having a three dimensional appearance for computer display system or portion thereof
- [73] 蘋果公司  
APPLE INC.  
One Apple Park Way Cupertino,  
California 95014,  
United States of America
- [74] BARRON & YOUNG INTELLECTUAL PROPERTY LIMITED  
Suite 617, Lakeside 2,  
No. 10 Science Park West Avenue,  
Hong Kong Science Park, Shatin,  
New Territories, Hong Kong

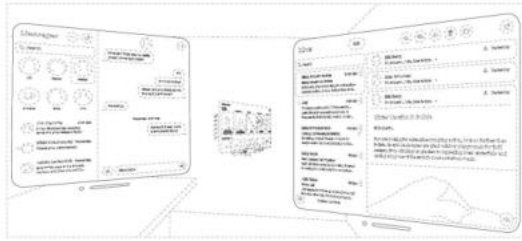

[11] 2322494.8M028

[15] 04-12-2023

[30] 04-06-2023 / US / 29/877,243

[51] Cl. 14-04

[54] 用於電腦顯示系統或其一部分的具有三維外觀的圖形用戶介面

Graphical user interface having a three dimensional appearance for computer display system or portion thereof

[73] 蘋果公司

APPLE INC.

One Apple Park Way Cupertino,

California 95014,

United States of America

[74] BARRON & YOUNG INTELLECTUAL PROPERTY LIMITED

Suite 617, Lakeside 2,

No. 10 Science Park West Avenue,

Hong Kong Science Park, Shatin,

New Territories, Hong Kong

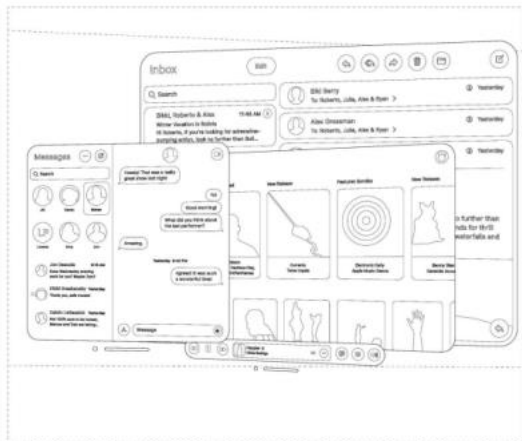

[11] 2322494.8M029

[15] 04-12-2023

[30] 04-06-2023 / US / 29/877,243

[51] Cl. 14-04

[54] 用於電腦顯示系統或其一部分的具有三維外觀的圖形用戶介面  
Graphical user interface having a three dimensional appearance  
for computer display system or portion thereof

[73] 蘋果公司  
APPLE INC.  
One Apple Park Way Cupertino,  
California 95014,  
United States of America

[74] BARRON & YOUNG INTELLECTUAL PROPERTY LIMITED  
Suite 617, Lakeside 2,  
No. 10 Science Park West Avenue,  
Hong Kong Science Park, Shatin,  
New Territories, Hong Kong

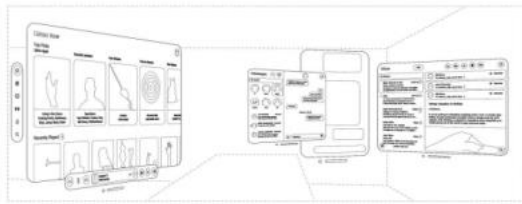

---

[11] 2322505.5M001

[15] 05-12-2023

[30] 05-06-2023 / US / 29/877,335

[51] C1. 14-04

[54] 用於電腦顯示系統或其一部分的具有三維外觀的圖形用戶介面  
Graphical user interface having a three dimensional appearance  
for computer display system or portion thereof

[73] 蘋果公司  
APPLE INC.  
One Apple Park Way Cupertino,  
California 95014,  
United States of America

[74] BARRON & YOUNG INTELLECTUAL PROPERTY LIMITED  
Suite 617, Lakeside 2,  
No. 10 Science Park West Avenue,  
Hong Kong Science Park, Shatin,  
New Territories, Hong Kong

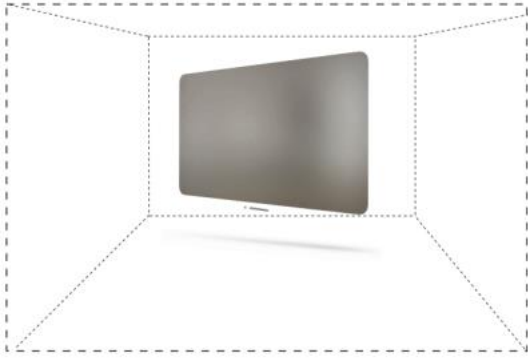

[11] 2322505.5M002

[15] 05-12-2023

[30] 05-06-2023 / US / 29/877,335

[51] Cl. 14-04

[54] 用於電腦顯示系統或其一部分的具有三維外觀的圖形用戶介面

Graphical user interface having a three dimensional appearance for computer display system or portion thereof

[73] 蘋果公司

APPLE INC.

One Apple Park Way Cupertino,

California 95014,

United States of America

[74] BARRON & YOUNG INTELLECTUAL PROPERTY LIMITED

Suite 617, Lakeside 2,

No. 10 Science Park West Avenue,

Hong Kong Science Park, Shatin,

New Territories, Hong Kong

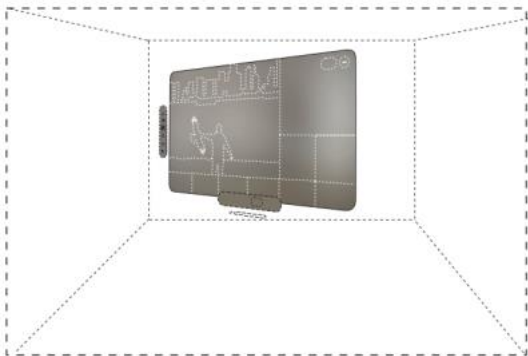

[11] 2322505.5M003

[15] 05-12-2023

[30] 05-06-2023 / US / 29/877,335

[51] Cl. 14-04



[54] 用於電腦顯示系統或其一部分的具有三維外觀的圖形用戶介面  
Graphical user interface having a three dimensional appearance  
for computer display system or portion thereof

[73] 蘋果公司  
APPLE INC.  
One Apple Park Way Cupertino,  
California 95014,  
United States of America

[74] BARRON & YOUNG INTELLECTUAL PROPERTY LIMITED  
Suite 617, Lakeside 2,  
No. 10 Science Park West Avenue,  
Hong Kong Science Park, Shatin,  
New Territories, Hong Kong

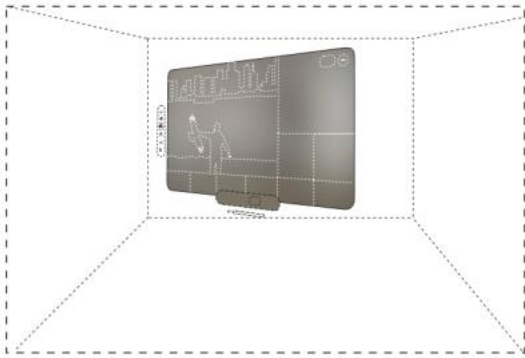

---

[11] 2322505.5M004

[15] 05-12-2023

[30] 05-06-2023 / US / 29/877,335

[51] Cl. 14-04

[54] 用於電腦顯示系統或其一部分的具有三維外觀的圖形用戶介面  
Graphical user interface having a three dimensional appearance  
for computer display system or portion thereof

[73] 蘋果公司  
APPLE INC.  
One Apple Park Way Cupertino,  
California 95014,  
United States of America

[74] BARRON & YOUNG INTELLECTUAL PROPERTY LIMITED  
Suite 617, Lakeside 2,  
No. 10 Science Park West Avenue,  
Hong Kong Science Park, Shatin,  
New Territories, Hong Kong

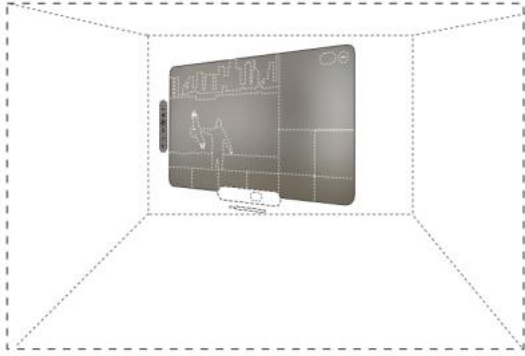

[11] 2322505.5M005

[15] 05-12-2023

[30] 05-06-2023 / US / 29/877,335

[51] Cl. 14-04

[54] 用於電腦顯示系統或其一部分的具有三維外觀的圖形用戶介面  
Graphical user interface having a three dimensional appearance  
for computer display system or portion thereof

[73] 蘋果公司

APPLE INC.

One Apple Park Way Cupertino,

California 95014,

United States of America

[74] BARRON & YOUNG INTELLECTUAL PROPERTY LIMITED

Suite 617, Lakeside 2,

No. 10 Science Park West Avenue,

Hong Kong Science Park, Shatin,

New Territories, Hong Kong

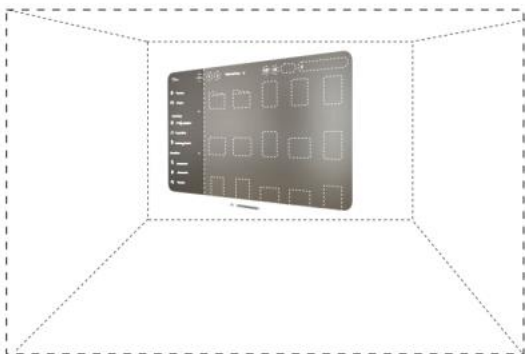

[11] 2322505.5M006

[15] 05-12-2023

[30] 05-06-2023 / US / 29/877,335

[51] Cl. 14-04

[54] 用於電腦顯示系統或其一部分的具有三維外觀的圖形用戶介面  
Graphical user interface having a three dimensional appearance  
for computer display system or portion thereof

[73] 蘋果公司  
APPLE INC.  
One Apple Park Way Cupertino,  
California 95014,  
United States of America

[74] BARRON & YOUNG INTELLECTUAL PROPERTY LIMITED  
Suite 617, Lakeside 2,  
No. 10 Science Park West Avenue,  
Hong Kong Science Park, Shatin,  
New Territories, Hong Kong

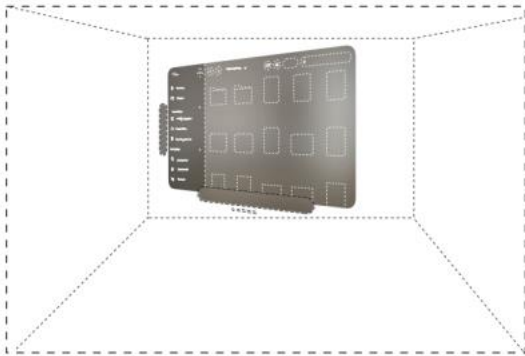

---

[11] 2322505.5M007

[15] 05-12-2023

[30] 05-06-2023 / US / 29/877,335

[51] Cl. 14-04

[54] 用於電腦顯示系統或其一部分的具有三維外觀的圖形用戶介面  
Graphical user interface having a three dimensional appearance  
for computer display system or portion thereof

[73] 蘋果公司  
APPLE INC.  
One Apple Park Way Cupertino,  
California 95014,  
United States of America

[74] BARRON & YOUNG INTELLECTUAL PROPERTY LIMITED  
Suite 617, Lakeside 2,  
No. 10 Science Park West Avenue,  
Hong Kong Science Park, Shatin,  
New Territories, Hong Kong

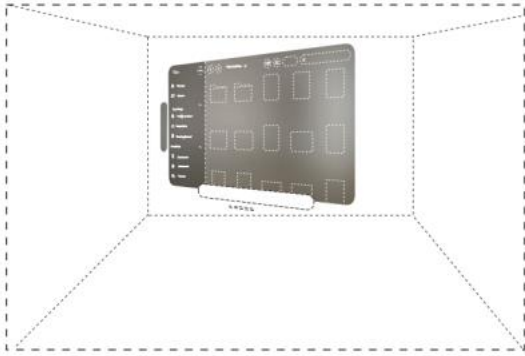

[11] 2322505.5M008

[15] 05-12-2023

[30] 05-06-2023 / US / 29/877,335

[51] Cl. 14-04

[54] 用於電腦顯示系統或其一部分的具有三維外觀的圖形用戶介面  
Graphical user interface having a three dimensional appearance  
for computer display system or portion thereof

[73] 蘋果公司

APPLE INC.

One Apple Park Way Cupertino,

California 95014,

United States of America

[74] BARRON & YOUNG INTELLECTUAL PROPERTY LIMITED

Suite 617, Lakeside 2,

No. 10 Science Park West Avenue,

Hong Kong Science Park, Shatin,

New Territories, Hong Kong

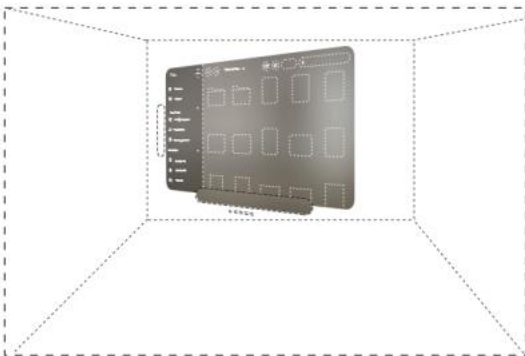

[11] 2322505.5M009

[15] 05-12-2023

[30] 05-06-2023 / US / 29/877,335

[51] Cl. 14-04

[54] 用於電腦顯示系統或其一部分的具有三維外觀的圖形用戶介面  
Graphical user interface having a three dimensional appearance  
for computer display system or portion thereof

[73] 蘋果公司  
APPLE INC.  
One Apple Park Way Cupertino,  
California 95014,  
United States of America

[74] BARRON & YOUNG INTELLECTUAL PROPERTY LIMITED  
Suite 617, Lakeside 2,  
No. 10 Science Park West Avenue,  
Hong Kong Science Park, Shatin,  
New Territories, Hong Kong

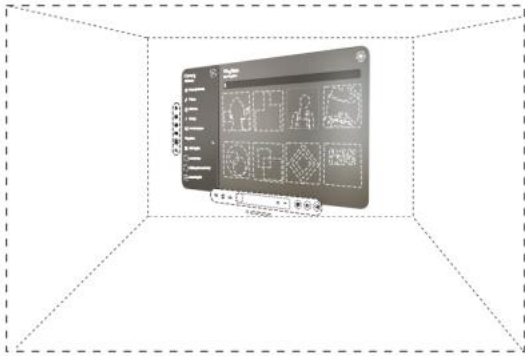

---

[11] 2322505.5M010

[15] 05-12-2023

[30] 05-06-2023 / US / 29/877,335

[51] Cl. 14-04

[54] 用於電腦顯示系統或其一部分的具有三維外觀的圖形用戶介面  
Graphical user interface having a three dimensional appearance  
for computer display system or portion thereof

[73] 蘋果公司  
APPLE INC.  
One Apple Park Way Cupertino,  
California 95014,  
United States of America

[74] BARRON & YOUNG INTELLECTUAL PROPERTY LIMITED  
Suite 617, Lakeside 2,  
No. 10 Science Park West Avenue,  
Hong Kong Science Park, Shatin,  
New Territories, Hong Kong

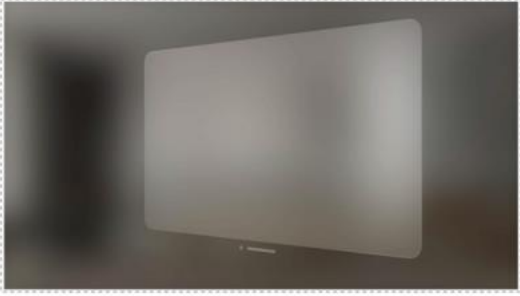

---

[11] 2322505.5M011

[15] 05-12-2023

[30] 05-06-2023 / US / 29/877,335

[51] Cl. 14-04

[54] 用於電腦顯示系統或其一部分的具有三維外觀的圖形用戶介面

Graphical user interface having a three dimensional appearance for computer display system or portion thereof

[73] 蘋果公司

APPLE INC.

One Apple Park Way Cupertino,  
California 95014,  
United States of America

[74] BARRON & YOUNG INTELLECTUAL PROPERTY LIMITED

Suite 617, Lakeside 2,  
No. 10 Science Park West Avenue,  
Hong Kong Science Park, Shatin,  
New Territories, Hong Kong

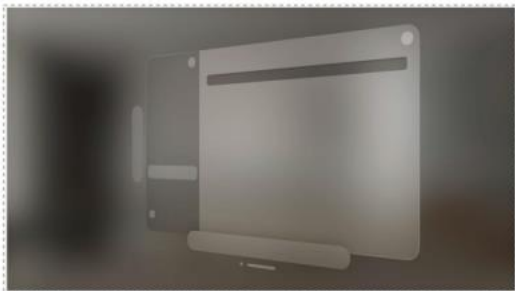

---

[11] 2322509.3

[15] 06-12-2023

[30] 19-07-2023 / EU / 015028555-0003

[51] Cl. 2-04

[54] 鞋

Shoes

[73] BOTTEGA VENETA S.R.L.

Località Conti Maltraverso 1,

36054 Montebello Vicentino (VI),  
Italy

[74] ELLALAN  
26th - 28th Floors, The Hennessy,  
256 Hennessy Road,  
Wanchai, Hong Kong



---

[11] 2322548.5M001

[15] 13-12-2023

[51] Cl. 10-05

[54] 嬰兒監控器  
Baby monitor

[73] 勤增新科技發展有限公司  
KAN TSANG NEW TECHNOLOGY DEVELOPMENT LIMITED  
Unit 1, 11/F, Nan Fung Commercial Centre,  
19 Lam Lok Street,  
Kowloon Bay, Kowloon, Hong Kong

[74] ACCOLADE IP LIMITED  
10/F, Fu Fai Comm. Ctr.,  
27 Hillier Street,  
Sheung Wan, Hong Kong



- [11] 2322548.5M002  
[15] 13-12-2023  
[51] Cl. 10-05  
[54] 嬰兒監控器  
Baby monitor  
[73] 勤增新科技發展有限公司  
KAN TSANG NEW TECHNOLOGY DEVELOPMENT LIMITED  
Unit 1, 11/F, Nan Fung Commercial Centre,  
19 Lam Lok Street,  
Kowloon Bay, Kowloon, Hong Kong  
[74] ACCOLADE IP LIMITED  
10/F, Fu Fai Comm. Ctr.,  
27 Hillier Street,  
Sheung Wan, Hong Kong



- 
- [11] 2322548.5M003  
[15] 13-12-2023  
[51] Cl. 10-05  
[54] 嬰兒監控器  
Baby monitor  
[73] 勤增新科技發展有限公司  
KAN TSANG NEW TECHNOLOGY DEVELOPMENT LIMITED  
Unit 1, 11/F, Nan Fung Commercial Centre,  
19 Lam Lok Street,  
Kowloon Bay, Kowloon, Hong Kong  
[74] ACCOLADE IP LIMITED  
10/F, Fu Fai Comm. Ctr.,  
27 Hillier Street,  
Sheung Wan, Hong Kong





---

[11] 2322548.5M004

[15] 13-12-2023

[51] Cl. 10-05

[54] 嬰兒監控器

Baby monitor

[73] 勤增新科技發展有限公司

KAN TSANG NEW TECHNOLOGY DEVELOPMENT LIMITED

Unit 1, 11/F, Nan Fung Commercial Centre,

19 Lam Lok Street,

Kowloon Bay, Kowloon, Hong Kong

[74] ACCOLADE IP LIMITED

10/F, Fu Fai Comm. Ctr.,

27 Hillier Street,

Sheung Wan, Hong Kong



- [11] 2322571.3  
[15] 19-12-2023  
[30] 19-06-2023 / FR / 20232788  
[51] Cl. 21-01  
[54] 塑像  
Figurine  
[73] LOUIS VUITTON MALLETIER  
2 rue du Pont-Neuf,  
75001 Paris,  
France  
[74] BAKER & MCKENZIE  
14th Floor, One Taikoo Place,  
979 King's Road,  
Quarry Bay, Hong Kong

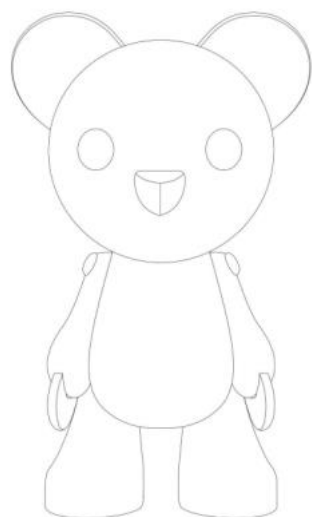

- 
- [11] 2322598.0  
[15] 27-12-2023  
[30] 20-09-2023 / US / 29/903,130  
[51] Cl. 20-01  
[54] 現做飲料販賣機  
Freshly made drink vending machine  
[73] YO-KAI EXPRESS INC.  
3501 breakwater ct,  
Hayward, CA 94545,  
United States of America  
[74] SO KEUNG YIP & SIN  
Room 1009-1012, 10/F., Nan Fung Tower,  
No. 173 Des Voeux Road Central,  
Hong Kong

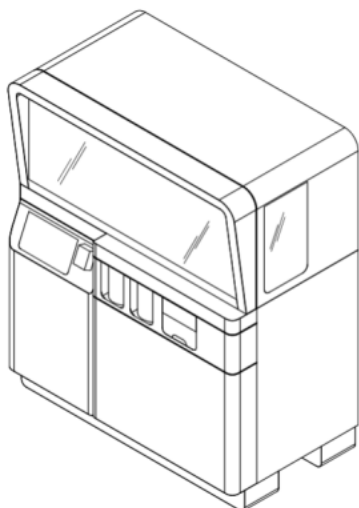

---

[11] 2422667.8M001

[15] 12-01-2024

[30] 13-07-2023 / EU / 015027929

[51] Cl. 12-12

[54] 嬰兒車  
Stroller

[73] Mamas & Papas (Holdings) Limited  
Colne Bridge Road,  
Huddersfield HD5 0RH,  
United Kingdom

[74] DEACONS  
5th Floor, Alexandra House,  
Central,  
Hong Kong



- [11] 2422667.8M002  
[15] 12-01-2024  
[30] 13-07-2023 / EU / 015027929  
[51] Cl. 12-12  
[54] 嬰兒車  
Stroller  
[73] Mamas & Papas (Holdings) Limited  
Colne Bridge Road,  
Huddersfield HD5 0RH,  
United Kingdom  
[74] DEACONS  
5th Floor, Alexandra House,  
Central,  
Hong Kong

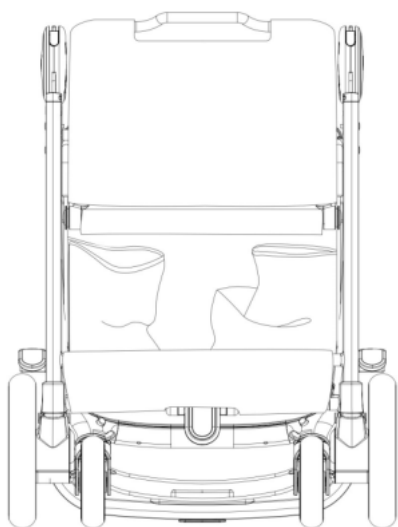

- 
- [11] 2422739.1  
[15] 25-01-2024  
[30] 13-12-2023 / CN / 202330821403.2  
[51] Cl. 15-99  
[54] 電梯巡檢機器人  
Elevator inspection robot  
[73] 廣東睿進智能科技有限公司  
GuangDong Rhizo Technologies Co., Ltd.  
中國廣東省  
廣州市黃埔區  
尖塔山路 5 號 517 室  
[74] 旻貝國際知識產權代理有限公司  
香港新界白石角

香港科學園第三期

科技大道西 12 號 2 樓 230 室



[11] 2422746.6

[15] 26-01-2024

[30] 28-07-2023 / US / 29/898,531

[51] Cl. 10-04

[54] 鏡片測量裝置

Lens measuring device

[73] 蘋果公司

APPLE INC.

One Apple Park Way,

Cupertino, California,

United States of America

[74] CLT PATENT & TRADEMARK (H.K.) LIMITED

Unit 09, 34/F., Office Tower, Convention Plaza,

1 Harbour Road,

Wanchai, Hong Kong

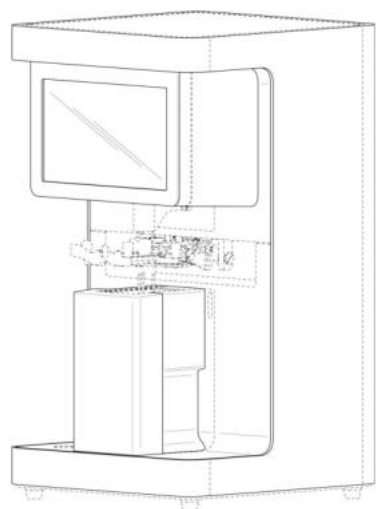

[11] 2422784.5

[15] 04-02-2024

[30] 07-08-2023 / CN / 2023304993969

[51] C1. 28-03

[54] 剃鬚刀  
Shaver

[73] 深圳市加減生活科技有限公司  
Shenzhen XIVOLIFE Technology Co., Ltd.  
中國深圳市南山區  
南頭街道安樂社區關口二路 15 號  
智恆產業園 7 棟 2 樓、3 樓

[74] 專利及設計有限公司  
香港屯門  
新安街 16 號  
百勝工業大廈 2A1 樓 A20 室



[11] 2422811.4

[15] 15-02-2024

[30] 14-09-2023 / CA, EG, BY, BA, BR, LI, MK, MX, MC, ME, NO, OM,  
CN, SM, RU, SG, CH, TR, UA, GB, US, VN, EU, IS, JP, KR /  
WIPO138358

[51] Cl. 10-02

[54] 手錶  
Watch

[73] Turlen Holding SA  
Rue du Jura 11,  
2345 Les Breuleux,  
Switzerland

[74] WILKINSON & GRIST  
6th Floor, Prince's Building,  
Chater Road,  
Hong Kong



---

[11] 2422813.8

[15] 15-02-2024

[51] Cl. 10-05

[54] 閘機  
Turnstile gate

[73] 密思達科研有限公司  
Matrix Research Limited  
香港荃灣  
白田壩街 5-21 號  
嘉力工業中心 A 座 16 樓 22 室

- [74] 密思達科研有限公司  
香港荃灣  
白田壩街 5-21 號  
嘉力工業中心 A 座 16 樓 22 室



- [11] 2422817.7M001  
[15] 15-02-2024  
[30] 30-08-2023 / AM, AZ, BZ, BA, GE, LI, MK, MD, MC, MN, ME, MA,  
NO, OM, SG, CH, TN, TR, UA, GB, EU, AL, KG / DM/231 696  
[51] Cl. 10-07  
[54] 錶殼  
Watch case  
[73] OMEGA SA (OMEGA AG) (OMEGA LTD.)  
Jakob-Stämpfli-Strasse 96,  
CH-2502 Biel/Bienne,  
Switzerland  
[74] SPRUSON & FERGUSON (HONG KONG) LIMITED  
5001 Hopewell Centre,  
183 Queen's Road East,  
Wan Chai, Hong Kong





[11] 2422817.7M002

[15] 15-02-2024

[30] 30-08-2023 / AM, AZ, BZ, BA, GE, LI, MK, MD, MC, MN, ME, MA,  
NO, OM, SG, CH, TN, TR, UA, GB, EU, AL, KG / DM/231 696

[51] Cl. 10-07

[54] 手錶時針

Watch hand

[73] OMEGA SA (OMEGA AG) (OMEGA LTD.)

Jakob-Stämpfli-Strasse 96,

CH-2502 Biel/Bienne,

Switzerland

[74] SPRUSON & FERGUSON (HONG KONG) LIMITED

5001 Hopewell Centre,

183 Queen's Road East,

Wan Chai, Hong Kong

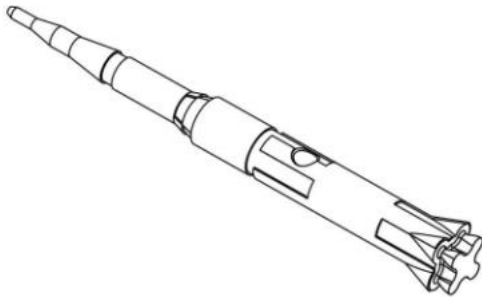

---

[11] 2422821.5

[15] 16-02-2024

[30] 18-08-2023 / EU / 015031474-0001

[51] Cl. 12-08

[54] 汽車

Vehicle

[73] AUTOMOBILI LAMBORGHINI S.P.A.

Via Modena 12,

40019 Sant' Agata Bolognese (BO),

Italy

[74] SHANGHAI INTELLECTUAL PROPERTY OFFICE

Unit F, 20th Floor, Neich Tower,

128 Gloucester Road,

Hong Kong



---

[11] 2422854.4M001

[15] 28-02-2024

[51] Cl. 11-01

[54] 吊墜

Pendant

[73] TAsAKI & Co., Ltd.

7-3-1 Minatojima Naka-machi,

Chuo-ku, Kobe,

Hyogo 650-0046, Japan

[74] DEACONS

5th Floor, Alexandra House,

Central,

Hong Kong

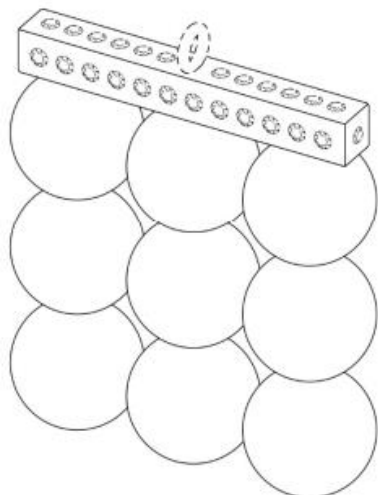

---

[11] 2422854.4M002

[15] 28-02-2024

[51] Cl. 11-01

[54] 指環

Finger ring

[73] TASAKI & Co., Ltd.

7-3-1 Minatojima Naka-machi,

Chuo-ku, Kobe,

Hyogo 650-0046, Japan

[74] DEACONS

5th Floor, Alexandra House,

Central,

Hong Kong

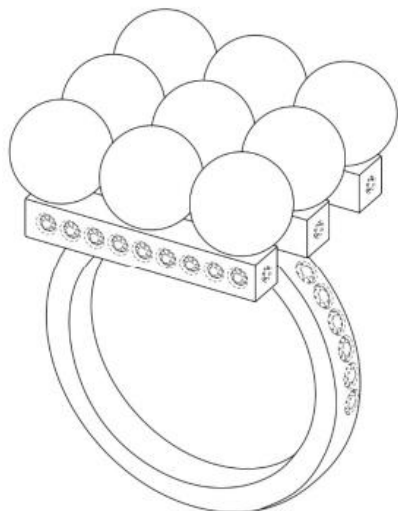

---

[11] 2422854.4M003

[15] 28-02-2024

[51] Cl. 11-01

[54] 耳環

Earring

[73] TASAKI & Co., Ltd.

7-3-1 Minatojima Naka-machi,

Chuo-ku, Kobe,

Hyogo 650-0046, Japan

[74] DEACONS

5th Floor, Alexandra House,

Central,

Hong Kong

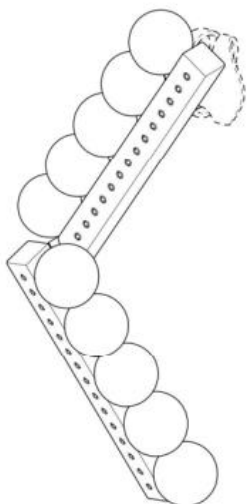

---

[11] 2422854.4M004

[15] 28-02-2024

[51] Cl. 11-01

[54] 吊墜

Pendant

[73] TASAKI & Co., Ltd.

7-3-1 Minatojima Naka-machi,

Chuo-ku, Kobe,

Hyogo 650-0046, Japan

[74] DEACONS

5th Floor, Alexandra House,

Central,

Hong Kong

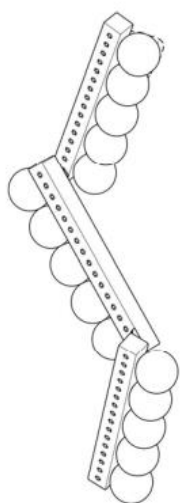

---

[11] 2422854.4M005

[15] 28-02-2024

[51] Cl. 11-01

[54] 吊墜

Pendant

[73] TASAKI & Co., Ltd.

7-3-1 Minatojima Naka-machi,

Chuo-ku, Kobe,

Hyogo 650-0046, Japan

[74] DEACONS

5th Floor, Alexandra House,

Central,

Hong Kong

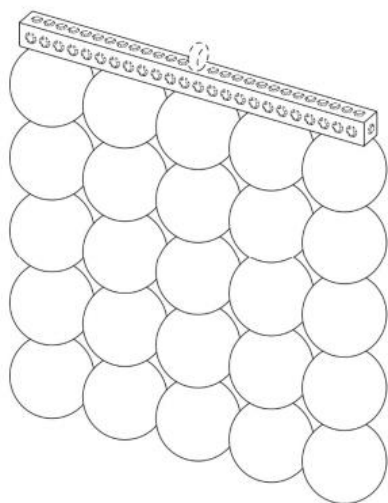



香港特別行政區政府知識產權署外觀設計註冊處

The Government of the Hong Kong Special Administrative Region

Designs Registry, Intellectual Property Department

根據註冊外觀設計條例第 28 條，下列註冊外觀設計因未繳續期費而停止有效。

各組記項按註冊外觀設計停止有效日期及註冊編號先後次序排列。

**Registered designs ceased through non-payment of renewal fees under section 28 of the Registered Designs Ordinance. Entries are listed below under their expiry dates.**

**23-02-2024 - 27-02-2024****23-02-2024**

1400315.4

1400329.3

**26-02-2024**

1913102.2

**24-02-2024**

0410391.3M001

1400330.5

1400336.8M001

1400336.8M002

1400336.8M003

1400336.8M004

1913079.2M001

1913079.2M002

1913082.8

1913084.2

1913085.5M001

1913085.5M002

1913085.5M003

1913085.5M004

**27-02-2024**

1400357.2M001

1400357.2M002

1400357.2M003

1400357.2M004

1400357.2M005

1400359.6

1400362.2

1400363.4

1400364.6

1802055.8

1913105.9

1913107.3

1913112.3

1913114.7

**25-02-2024**

1400339.4

1400342.0M002

1400342.0M003

1400342.0M004

1400342.0M005

1400345.7

1913086.7

1913087.9

1913088.1

1913094.3

1913095.6

1913096.8



香港特別行政區政府知識產權署外觀設計註冊處

The Government of the Hong Kong Special Administrative Region

Designs Registry, Intellectual Property Department

根據註冊外觀設計規則第 31 條刪除的註冊外觀設計。各組記項按註冊外觀設計刪除日期及註冊編號先後次序排列。

**Registered designs removed under section 31 of the Registered Designs Rules. Entries are listed below under their removal dates.**

**01-03-2024 - 07-03-2024**

**01-03-2024**

1301435.8

1301437.2

**07-03-2024**

1301472.5

1801767.7

**02-03-2024**

1801737.4

**03-03-2024**

0311376.2

0802094.7M001

0802094.7M002

**04-03-2024**

1301443.4

1301445.9

**05-03-2024**

1301449.7

1301450.9

1301451.1

1301452.3

1801749.9

1801758.8

**06-03-2024**

0802108.9

1301459.8

1301460.0M001

1301465.1M001

1301465.1M002

1301465.1M003

1301465.1M004

1301466.3M001

1801763.8



香港特別行政區政府知識產權署外觀設計註冊處

The Government of the Hong Kong Special Administrative Region

Designs Registry, Intellectual Property Department

## 根據註冊外觀設計條例第 76 條，更正已提交文件中的錯誤

### Correction of errors in filed documents under section 76 of the Registered Designs Ordinance

任何人士現可對下列更正錯誤的請求提出反對

Request for correction of errors now open to opposition

如任何人士意欲反對下列請求，則須在本官方公報刊登是項更正請求的日期起計的兩個月內，根據註冊外觀設計規則第 62(4) 條，採用指明外觀設計表格第 D9 號提交反對通知。如在限期內沒有收到任何反對通知，處長將依本公報刊登的更正請求的內容，准許是項更正請求。

If any person wishes to oppose the following request, he shall file a notice of opposition in specified Designs Form D9 within two months from the date of advertisement in this official journal under section 62(4) of the Registered Designs Rules. If no notice of opposition is received, the request for correction will be allowed by the Registrar in the present advertised form.

請求更正下列錯誤：

1. 增補漏記的根據註冊外觀設計條例第16條聲稱享有的優先權及
2. 在外觀設計表格第D1號第08部分增補優先權申請提交日期、國家及編號。

Request made for correction of the following errors:

1. addition of a priority claim under section 16 of the Registered Designs Ordinance; and
2. addition of the priority application date, country and number to Part 08 of the Designs Form D1 filed.

[21] 2422857.1

[30] 29-08-2023 / JP / 017448 of 2023