

香港知識產權公報

Hong Kong Intellectual Property Journal

2024年4月26日

26 April 2024



目錄 Contents

根據註冊外觀設計條例第 25 條註冊的外觀設計

Designs Registered under section 25 of the Registered Designs Ordinance

按註冊編號排列

Arranged by Registration Number

根據註冊外觀設計條例(第 522 章)公布的其他公告

Other Notices Published under the Registered Designs Ordinance (Cap. 522)

根據註冊外觀設計條例第 28 條，註冊外觀設計因未繳續期費而停止有效

Registered designs ceased through non-payment of renewal fees under section 28 of the Registered Designs Ordinance

根據註冊外觀設計規則第 31 條刪除的註冊外觀設計

Registered designs removed under section 31 of the Registered Designs Rules

根據註冊外觀設計條例第 67 及 76 條，更正註冊紀錄冊內及已提交文件中的錯誤

Correction of Errors in Register and in Filed Documents under sections 67 and 76 of the Registered Designs Ordinance

以下事項沒有記錄

No Records for the Following Matters

根據註冊外觀設計條例第 30 條放棄的外觀設計的註冊

Surrender of Registration of Design under section 30 of the Registered Designs Ordinance

根據註冊外觀設計規則第 37 條，向處長作出轉介

Reference to Registrar under section 37 of the Registered Designs Rules

根據註冊外觀設計條例第 45 條，撤銷註冊

Revocation of Registration under section 45 of the Registered Designs Ordinance

根據註冊外觀設計規則第 46 條，向法院作出轉介

Reference to Court under section 46 of the Registered Designs Rules

根據註冊外觀設計規則第 63 條對不符合規定之處作出糾正

Rectification of Irregularities under section 63 of the Registered Designs Rules

根據註冊外觀設計條例第 66 條，糾正註冊紀錄冊

Rectification of Register under section 66 of the Registered Designs Ordinance

根據註冊外觀設計條例第 67 條 更正註冊紀錄冊內的錯誤

Correction of errors in Register under section 67 of the Registered Designs Ordinance

根據註冊外觀設計條例第 76 條，更正已提交文件中的錯誤

Correction of errors in filed documents under section 76 of the Registered Designs Ordinance

勘誤

Corrigendum

註冊外觀設計公告註釋

Notes on advertisements of registration of designs

方括號表示下列資料：

Square brackets indicate the following data：

[11] 註冊編號 Registration number / 聯合王國註冊編號 United Kingdom registration number

[15] 註冊日期 Registration date / 當作註冊日期 Deemed registration date / 聯合王國註冊日期 United Kingdom registration date

[17] 註冊有效期屆滿日期 Expiry date of the period of registration

[22] 提交日期 Filing date / 當作提交日期 Deemed filing date / 聯合王國提交日期 United Kingdom filing date

[30] 聲稱享有的優先權（提交日期 / 巴黎公約國或世界貿易組織成員 / 申請編號） Priority claimed (filing date / Paris Convention country or WTO member / application number)

[51] 國際外觀設計分類號（洛迦諾分類號） International Classification of designs (Locarno Classification)

[54] 物品 Article

[55] 外觀設計的表述 Representation of the design

[62] 分開前的申請編號及提交日期 Application number before division and filing date

[66] 過往註冊的聯繫外觀設計註冊編號 / 日期 Registration No. / Date of Previous Registration for Association

[72] 設計人 Designer

[73] 擁有人姓名和地址 Name and address of the owner

[74] 代理人 Agent / 送達地址 Address for service



香港特別行政區政府知識產權署外觀設計註冊處

The Government of the Hong Kong Special Administrative Region

Designs Registry, Intellectual Property Department

根據註冊外觀設計條例第 25 條註冊的外觀設計

Designs registered under section 25 of the Registered Designs Ordinance

按註冊編號排列

Arranged by Registration Number

- [11] 2321190.3M001
- [15] 20-03-2023
- [30] 20-09-2022 / EU / 009179211
- [51] Cl. 1-02
- [54] 馬鈴薯切製食品
Cut potato product
- [73] 蘭博-韋斯頓 梅傑公司
Lamb-Weston/Meijer V.O.F.
Stationsweg 18a,
PJ Kruiningen, 4416,
Netherlands
- [74] MARKS & CLERK
Level 9, Cyberport 1,
100 Cyberport Road,
Pok Fu Lam, Hong Kong

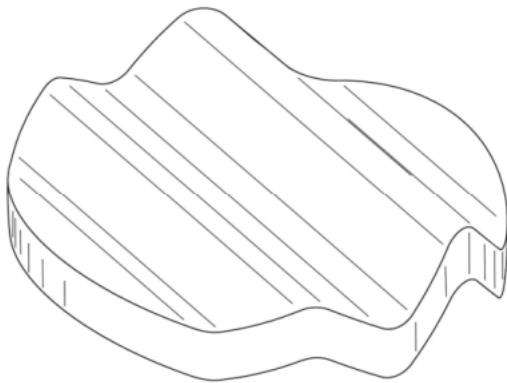

-
- [11] 2321190.3M002
 - [15] 20-03-2023
 - [30] 20-09-2022 / EU / 009179211
 - [51] Cl. 1-02

[54] 馬鈴薯切製食品

Cut potato product

[73] 蘭博-韋斯頓 梅傑公司

Lamb-Weston/Meijer V.O.F.

Stationsweg 18a,

PJ Kruiningen, 4416,

Netherlands

[74] MARKS & CLERK

Level 9, Cyberport 1,

100 Cyberport Road,

Pok Fu Lam, Hong Kong

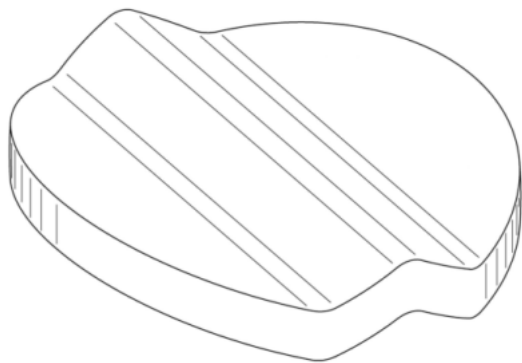

[11] 2321190.3M003

[15] 20-03-2023

[30] 20-09-2022 / EU / 009179211

[51] Cl. 1-02

[54] 馬鈴薯切製食品

Cut potato product

[73] 蘭博-韋斯頓 梅傑公司

Lamb-Weston/Meijer V.O.F.

Stationsweg 18a,

PJ Kruiningen, 4416,

Netherlands

[74] MARKS & CLERK

Level 9, Cyberport 1,

100 Cyberport Road,

Pok Fu Lam, Hong Kong

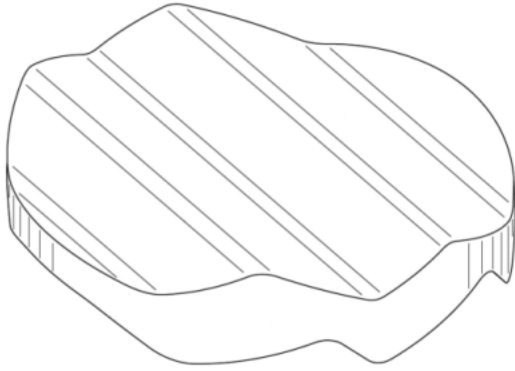

[11] 2321190.3M004

[15] 20-03-2023

[30] 20-09-2022 / EU / 009179211

[51] Cl. 1-02

[54] 馬鈴薯切製食品

Cut potato product

[73] 蘭博-韋斯頓 梅傑公司

Lamb-Weston/Meijer V.O.F.

Stationsweg 18a,

PJ Kruiningen, 4416,

Netherlands

[74] MARKS & CLERK

Level 9, Cyberport 1,

100 Cyberport Road,

Pok Fu Lam, Hong Kong

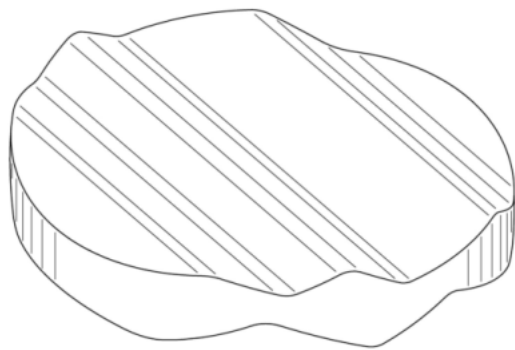

[11] 2321190.3M005

[15] 20-03-2023

[30] 20-09-2022 / EU / 009179211

[51] Cl. 1-02

[54] 馬鈴薯切製食品

Cut potato product

[73] 蘭博-韋斯頓 梅傑公司
Lamb-Weston/Meijer V.O.F.
Stationsweg 18a,
PJ Kruiningen, 4416,
Netherlands

[74] MARKS & CLERK
Level 9, Cyberport 1,
100 Cyberport Road,
Pok Fu Lam, Hong Kong

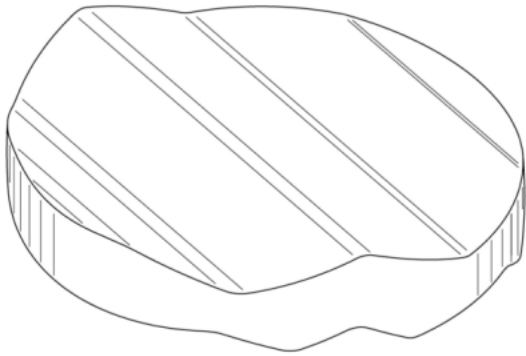

[11] 2322161.3
[15] 30-09-2023
[30] 02-04-2023 / FR / 20231548
[51] Cl. 11-01

[54] 首飾
Jewellery

[73] LOUIS VUITTON MALLETIER
2 rue du Pont-Neuf,
75001 Paris,
France

[74] BAKER & MCKENZIE
14th Floor, One Taikoo Place,
979 King's Road,
Quarry Bay, Hong Kong



[11] 2322245.2
[15] 20-10-2023

[30] 21-07-2023 / JP / 015022 of 2023

[51] Cl. 3-01

[54] 釣魚竿盒的拉鍊

Fastener for fishing rod case

[73] 古洛布萊株式會社

GLOBERIDE, Inc.

3-14-16 Maesawa,

Higashikurume-shi,

Tokyo, 203-8511, Japan

[74] Sunhope Intellectual Property Limited (Attn: Miss Fiona Ko)

Room 902, 9/F, Qualipak Tower,

No. 121-122 Connaught Road West,

Hong Kong

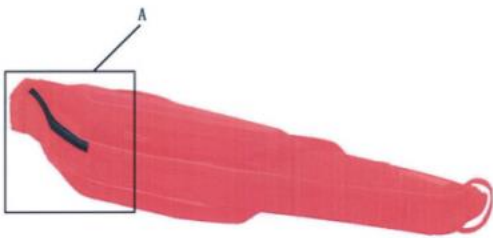

[11] 2322435.5M001

[15] 29-11-2023

[51] Cl. 21-01

[54] 模型車

Model car

[73] Dr. Ing. h.c. F. Porsche Aktiengesellschaft

Porscheplatz 1,

70435 Stuttgart,

Germany

[74] WENPING PATENT & TRADE MARK AGENT LIMITED

1701 Tung Wai Commercial Building,

111 Gloucester Road,

Hong Kong



[11] 2322435.5M002

[15] 29-11-2023

[51] Cl. 21-01

[54] 模型車

Model car

[73] Dr. Ing. h.c. F. Porsche Aktiengesellschaft

Porscheplatz 1,
70435 Stuttgart,
Germany

[74] WENPING PATENT & TRADE MARK AGENT LIMITED

1701 Tung Wai Commercial Building,
111 Gloucester Road,
Hong Kong



[11] 2322523.2

[15] 07-12-2023

[51] Cl. 30-01

[54] 動物可穿戴設備上的防滑墊設計

Non slip pad design on animal wearables

[73] 香港特別行政區政府 (香港海關)

The Government of the Hong Kong Special Administrative Region
(Hong Kong Customs and Excise Department)
3/F, Customs Canine Force Headquarters,
16.5 miles Castle Peak Road,
Tai Lam, New Territories, Hong Kong

[74] 朱綽帆

香港

香港島東區天后

金龍臺 5 號金龍閣 22 樓 B 室

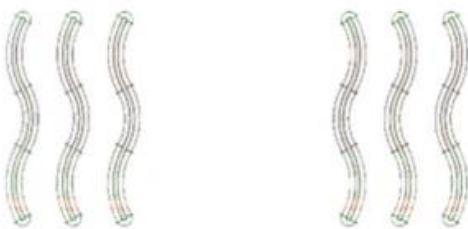

[11] 2322542.2

[15] 12-12-2023

[30] 14-06-2023 / GB / 6289936

[51] Cl. 28-06

[54] 頭髮造型和頭髮護理裝置(的附件)

Hair styling and hair care apparatus (accessories for-)

[73] Dyson Technology Limited
Tetbury Hill, Malmesbury,
Wiltshire, SN16 0RP,
United Kingdom

[74] LIU, SHEN & ASSOCIATES
Room 3716, 37/F, Sun Hung Kai Centre,
30 Harbour Road,
Wanchai, Hong Kong

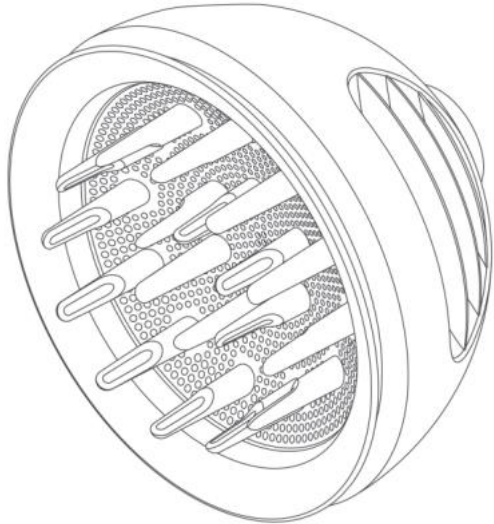

[11] 2422732.6

[15] 24-01-2024

[30] 08-09-2023 / SE / 2023-0163

[51] Cl. 12-16

[54] 車輛用充電口艙板

Charging hatch for vehicle

[73] Scania CV AB
SE-151 87 Södertälje,
Sweden

[74] NTD PATENT & TRADE MARK AGENCY LIMITED
Units 1805-6, 18/F.,
Greenfield Tower, Concordia Plaza,

No. 1 Science Museum Road,
Tsimshatsui East, Kowloon, Hong Kong



[11] 2422893.6M001

[15] 05-03-2024

[30] 26-09-2023 / KR / 30-2023-0038366

[51] Cl. 1-01

[54] 炒飯

Fried rice

[73] OK, MOOL GYEUL

1804ho, 412dong, 12 Dongnimyongsan-ro,
Buk-gu, Gwangju, 61097,
Republic of Korea

OK, GA EUL

1804ho, 412dong, 12 Dongnimyongsan-ro,
Buk-gu, Gwangju, 61097,
Republic of Korea

[74] CHINAHONGKONG PATENT LIMITED

1502, 15/F, Capital Centre,
151 Gloucester Road,
Wanchai, Hong Kong



[11] 2422893.6M002

[15] 05-03-2024

[30] 25-09-2023 / KR / 30-2023-0037951

[51] Cl. 1-05

[54] 豆腐

Bean curd

[73] OK, MOOL GYEUL

1804ho, 412dong, 12 Dongnimyongsan-ro,

Buk-gu, Gwangju, 61097,

Republic of Korea

OK, GA EUL

1804ho, 412dong, 12 Dongnimyongsan-ro,

Buk-gu, Gwangju, 61097,

Republic of Korea

[74] CHINAHONGKONG PATENT LIMITED

1502, 15/F, Capital Centre,

151 Gloucester Road,

Wanchai, Hong Kong



[11] 2422893.6M003

[15] 05-03-2024

[30] 26-09-2023 / KR / 30-2023-0038367

[51] Cl. 1-01

[54] 拌飯

Bibimbap

[73] OK, MOOL GYEUL

1804ho, 412dong, 12 Dongnimyongsan-ro,

Buk-gu, Gwangju, 61097,

Republic of Korea

OK, GA EUL

1804ho, 412dong, 12 Dongnimyongsan-ro,

Buk-gu, Gwangju, 61097,

Republic of Korea

[74] CHINAHONGKONG PATENT LIMITED

1502, 15/F, Capital Centre,

151 Gloucester Road,

Wanchai, Hong Kong



[11] 2422893.6M004

[15] 05-03-2024

[30] 25-09-2023 / KR / 30-2023-0037953

[51] Cl. 1-01

[54] 拉麵

Ramen

[73] OK, MOOL GYEUL

1804ho, 412dong, 12 Dongnimyongsan-ro,

Buk-gu, Gwangju, 61097,

Republic of Korea

OK, GA EUL

1804ho, 412dong, 12 Dongnimyongsan-ro,

Buk-gu, Gwangju, 61097,

Republic of Korea

[74] CHINAHONGKONG PATENT LIMITED

1502, 15/F, Capital Centre,

151 Gloucester Road,

Wanchai, Hong Kong



[11] 2422893.6M005

[15] 05-03-2024

[30] 25-09-2023 / KR / 30-2023-0037952

[51] Cl. 1-01

[54] 辣年糕

Tteokbokki

[73] OK, MOOL GYEUL

1804ho, 412dong, 12 Dongnimyongsan-ro,

Buk-gu, Gwangju, 61097,

Republic of Korea

OK, GA EUL

1804ho, 412dong, 12 Dongnimyongsan-ro,

Buk-gu, Gwangju, 61097,

Republic of Korea

[74] CHINAHONGKONG PATENT LIMITED

1502, 15/F, Capital Centre,

151 Gloucester Road,

Wanchai, Hong Kong



[11] 2422893.6M006

[15] 05-03-2024

[30] 22-02-2024 / KR / 30-2024-0007133

[51] Cl. 1-01

[54] 饅頭

Mandu

[73] OK, MOOL GYEUL

1804ho, 412dong, 12 Dongnimyongsan-ro,

Buk-gu, Gwangju, 61097,

Republic of Korea

OK, GA EUL

1804ho, 412dong, 12 Dongnimyongsan-ro,

Buk-gu, Gwangju, 61097,

Republic of Korea

[74] CHINAHONGKONG PATENT LIMITED

1502, 15/F, Capital Centre,

151 Gloucester Road,

Wanchai, Hong Kong

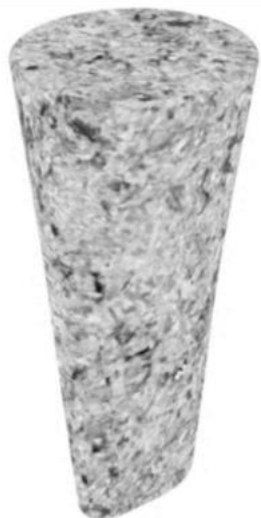

[11] 2422909.2

[15] 07-03-2024

[30] 23-10-2023 / KR / 30-2023-0041421

[51] Cl. 9-03

[54] 包裝盒

Box for packaging

[73] INNISFREE CORPORATION

100, Hangang-daero,

Yongsan-gu, Seoul,

Republic of Korea

[74] TRADEMARKCN COMPANY LIMITED

Block A, 4/F., Granville Building,

14 Granville Road,

Tsim Sha Tsui, Kowloon, Hong Kong



- [11] 2422948.4M001
[15] 14-03-2024
[30] 21-12-2023 / EU / 015045254-0001
[51] Cl. 28-03
[54] 氣味擴散器
Scent diffuser
[73] DIPTYQUE S.A.S.
34, boulevard Saint Germain,
F-75005 Paris,
France
[74] ECCLES & LEE
Suite 3212, Jardine House,
1 Connaught Place,
Central, Hong Kong



-
- [11] 2422948.4M002
[15] 14-03-2024
[30] 21-12-2023 / EU / 015045254-0002
[51] Cl. 28-03
[54] 氣味擴散器(的部分)
Scent diffuser (part of-)
[73] DIPTYQUE S.A.S.
34, boulevard Saint Germain,
F-75005 Paris,
France
[74] ECCLES & LEE
Suite 3212, Jardine House,
1 Connaught Place,
Central, Hong Kong



[11] 2422956.1

[15] 14-03-2024

[30] 20-10-2023 / CN / 2023306814605

[51] Cl. 22-03

[54] 電子鞭炮

E-firecracker

[73] 深圳豪喜气咨询管理有限公司

Shenzhen Haoxiqi Consulting Management Co., Ltd.

中國广东省

深圳市宝安区新桥街道

万丰社区福镇围 18 号 301

[74] LISHI INTELLECTUAL PROPERTY GROUP (INTERNATIONAL) LIMITED

香港九龍觀塘

興業街 15-17 號

中美中心 B 座 9 樓 9045 室

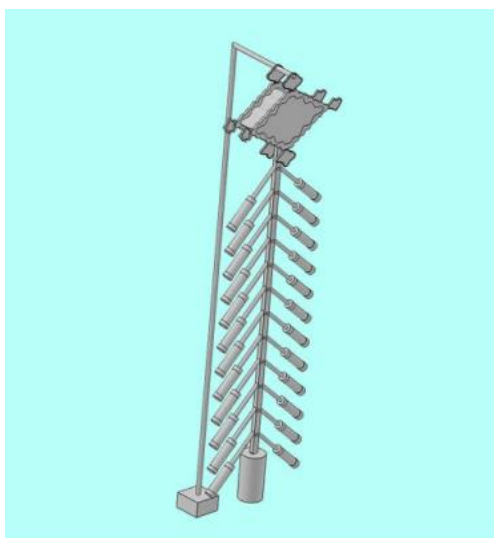

- [11] 2422977.5
[15] 19-03-2024
[51] Cl. 23-04
[54] 扇葉
Fan impeller
[73] WIN&WIN FINE INTERNATIONAL CO., LIMITED
Unit C, 9/F, Winning House,
No.72-76, Wing Lok Street,
Sheung Wan, Hong Kong
[74] JENNY AND PATRICK MARKETING COMPANY LIMITED
Level 12, Infinitus Plaza,
199 Des Voeux Road Central,
Sheung Wan, Hong Kong

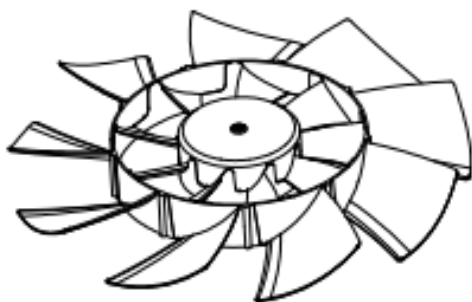

- [11] 2422982.5
[15] 19-03-2024
[30] 06-10-2023 / CA, AZ, BR, LI, MC, MA, CN, RU, SG, CH, TR, GB,
VN, EU, JP, KR / DM/232496
[51] Cl. 11-01
[54] 吊墜
Pendant
[73] Bulgari S.p.A.
11 Lungotevere Marzio,
00186 Rome,
Italy
[74] ATL LAW OFFICES
16/F., China Hong Kong Tower,
8-12 Hennessy Road,
Wanchai, Hong Kong



[11] 2422983.7

[15] 19-03-2024

[30] 27-09-2023 / AM, AZ, BZ, BA, GE, LI, MK, MD, MC, MN, ME, MA,
NO, OM, RU, SG, CH, TN, TR, UA, GB, EU, AL, KG / DM/232494

[51] Cl. 10-07

[54] 手錶機芯

Watch movement

[73] OMEGA SA (OMEGA AG) (OMEGA LTD.)

Jakob-Stämpfli-Strasse 96,

CH-2502 Biel/Bienne,

Switzerland

[74] SPRUSON & FERGUSON (HONG KONG) LIMITED

5001 Hopewell Centre,

183 Queen's Road East,

Wan Chai, Hong Kong



- [11] 2422987.6
- [15] 20-03-2024
- [30] 13-10-2023 / CA, AM, AZ, BZ, BA, GE, LI, MK, MD, MX, MC, MN, ME, MA, NO, OM, RU, SG, CH, TN, TR, UA, GB, EU, AL, JP, KR, KG / DM/232663
- [51] Cl. 10-02
- [54] 手錶
Wristwatch
- [73] MIDO AG (MIDO SA) (MIDO LTD)
Chemin des Tourelles 17,
CH-2400 Le Locle,
Switzerland
- [74] SPRUSON & FERGUSON (HONG KONG) LIMITED
5001 Hopewell Centre,
183 Queen's Road East,
Wan Chai, Hong Kong



-
- [11] 2422988.8M001
- [15] 20-03-2024
- [30] 22-09-2023 / SG, CH, TR, GB, EU / DM/233069
- [51] Cl. 10-07
- [54] 錶面
Dial
- [73] HAMILTON INTERNATIONAL AG (HAMILTON INTERNATIONAL SA)
(HAMILTON INTERNATIONAL LTD.)
Länggasse 85,
2504 Biel/Bienne,
Switzerland
- [74] SPRUSON & FERGUSON (HONG KONG) LIMITED
5001 Hopewell Centre,
183 Queen's Road East,
Wan Chai, Hong Kong

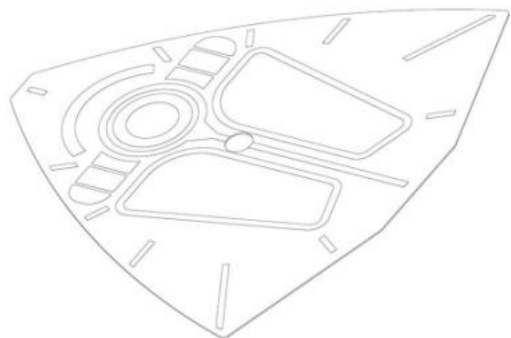

[11] 2422988.8M002

[15] 20-03-2024

[30] 22-09-2023 / SG, CH, TR, GB, EU / DM/233069

[51] Cl. 10-07

[54] 錶面
Dial

[73] HAMILTON INTERNATIONAL AG (HAMILTON INTERNATIONAL SA)
(HAMILTON INTERNATIONAL LTD.)
Länggasse 85,
2504 Biel/Bienne,
Switzerland

[74] SPRUSON & FERGUSON (HONG KONG) LIMITED
5001 Hopewell Centre,
183 Queen's Road East,
Wan Chai, Hong Kong

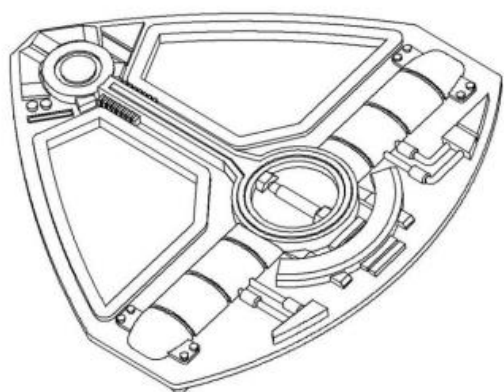

[11] 2422988.8M003

[15] 20-03-2024

[30] 22-09-2023 / SG, CH, TR, GB, EU / DM/233069

[51] Cl. 10-07

[54] 錶殼

Watch case

[73] HAMILTON INTERNATIONAL AG (HAMILTON INTERNATIONAL SA)
(HAMILTON INTERNATIONAL LTD.)

Länggasse 85,
2504 Biel/Bienne,
Switzerland

[74] SPRUSON & FERGUSON (HONG KONG) LIMITED

5001 Hopewell Centre,
183 Queen's Road East,
Wan Chai, Hong Kong

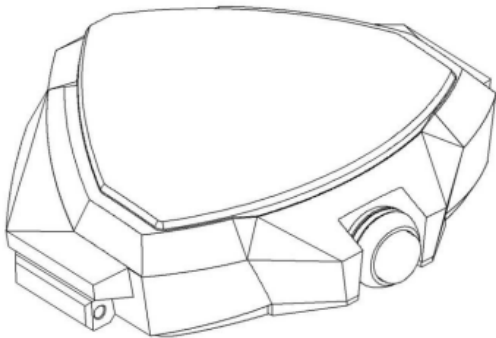

[11] 2422988.8M004

[15] 20-03-2024

[30] 22-09-2023 / SG, CH, TR, GB, EU / DM/233069

[51] Cl. 10-07

[54] 手錶錶帶

Watch bracelet

[73] HAMILTON INTERNATIONAL AG (HAMILTON INTERNATIONAL SA)
(HAMILTON INTERNATIONAL LTD.)

Länggasse 85,
2504 Biel/Bienne,
Switzerland

[74] SPRUSON & FERGUSON (HONG KONG) LIMITED

5001 Hopewell Centre,
183 Queen's Road East,
Wan Chai, Hong Kong

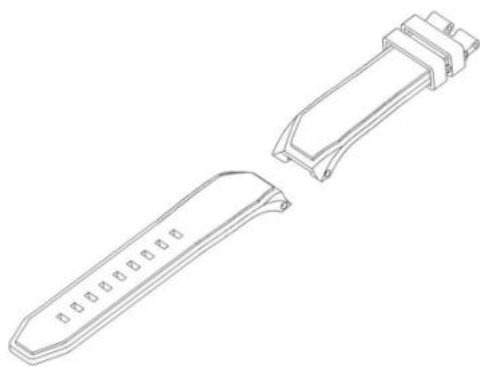

[11] 2422993.8

[15] 21-03-2024

[51] Cl. 28-03

[54] 按摩梳

Massager brush

[73] 渲美美健(深圳)科技股份有限公司

TOUCHBEAUTY BEAUTY & HEALTH (SHENZHEN) CO., LTD

中國深圳市

南山区粤海街道海珠社区海德三道

195 号天利中央商务广场(二期)B2901

[74] 海思国际知识产权有限公司

香港九龍

觀塘道 348 號

宏利廣場 6 樓



[11] 2422994.0M001

[15] 21-03-2024

[30] 16-10-2023 / EU / 015037216-0001

[51] Cl. 2-07

[54] 裝飾用鈕扣

Ornamental button

[73] Salvatore Ferragamo S.p.A.

Via dei Tornabuoni 2,

50123 Firenze,

Italy

[74] GALLANT

5/F, Jardine House,

1 Connaught Place,

Central, Hong Kong

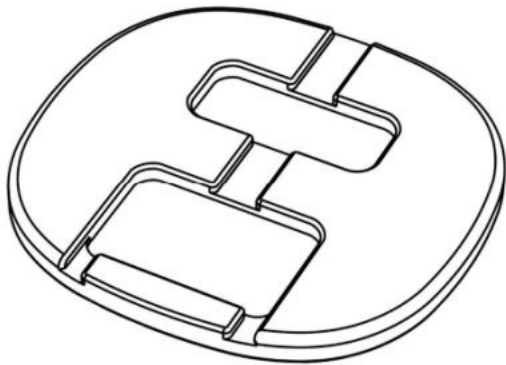

[11] 2422994.0M002

[15] 21-03-2024

[30] 16-10-2023 / EU / 015037216-0002

[51] Cl. 2-07

[54] 裝飾用鈕扣

Ornamental button

[73] Salvatore Ferragamo S.p.A.

Via dei Tornabuoni 2,

50123 Firenze,

Italy

[74] GALLANT

5/F, Jardine House,

1 Connaught Place,

Central, Hong Kong

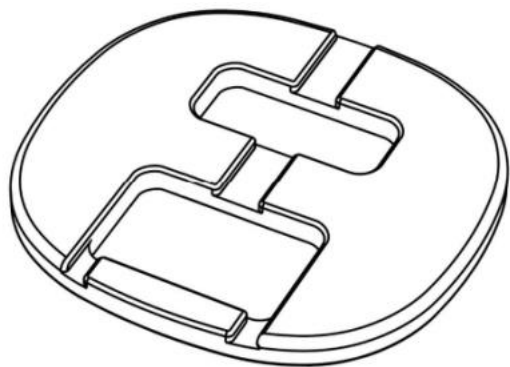

[11] 2422999.1M001

[15] 22-03-2024

[51] Cl. 11-01

[54] 手鐲

Bracelet

[73] 周生生珠寶金行有限公司

Chow Sang Sang Jewellery Company Limited
4/F., Chow Sang Sang Building,
229 Nathan Road,
Kowloon, Hong Kong

[74] HKIPA LIMITED

Unit 230, 2/F, Building 12W,
No. 12 Science Park West Avenue,
Phase 3, Hong Kong Science Park,
Pak Shek Kok, New Territories, Hong Kong



[11] 2422999.1M002

[15] 22-03-2024

[51] Cl. 11-01

[54] 戒指

Ring

- [73] 周生生珠寶金行有限公司
Chow Sang Sang Jewellery Company Limited
4/F., Chow Sang Sang Building,
229 Nathan Road,
Kowloon, Hong Kong
- [74] HKIPA LIMITED
Unit 230, 2/F, Building 12W,
No. 12 Science Park West Avenue,
Phase 3, Hong Kong Science Park,
Pak Shek Kok, New Territories, Hong Kong



-
- [11] 2422999.1M003
- [15] 22-03-2024
- [51] Cl. 11-01
- [54] 手鐲
Bracelet
- [73] 周生生珠寶金行有限公司
Chow Sang Sang Jewellery Company Limited
4/F., Chow Sang Sang Building,
229 Nathan Road,
Kowloon, Hong Kong
- [74] HKIPA LIMITED
Unit 230, 2/F, Building 12W,
No. 12 Science Park West Avenue,
Phase 3, Hong Kong Science Park,
Pak Shek Kok, New Territories, Hong Kong



[11] 2422999.1M004

[15] 22-03-2024

[51] Cl. 11-01

[54] 戒指
Ring

[73] 周生生珠寶金行有限公司
Chow Sang Sang Jewellery Company Limited
4/F., Chow Sang Sang Building,
229 Nathan Road,
Kowloon, Hong Kong

[74] HKIPA LIMITED
Unit 230, 2/F, Building 12W,
No. 12 Science Park West Avenue,
Phase 3, Hong Kong Science Park,
Pak Shek Kok, New Territories, Hong Kong



[11] 2423000.5

[15] 22-03-2024

[51] Cl. 11-01

[54] 吊咀

Pendant

[73] 蒂廷國際有限公司

香港九龍紅磡

民裕街 41 號

凱旋工商中心一期 1 樓 A3 室

[74] 蒂廷國際有限公司

香港九龍紅磡

民裕街 41 號

凱旋工商中心一萬 1 樓 A3 室



[11] 2423003.1

[15] 22-03-2024

[51] Cl. 11-01

[54] 手鏈

Bracelet

[73] 蒂廷國際有限公司

香港九龍紅磡

民裕街 41 號

凱旋工商中心一期 1 樓 A3 室

[74] 蒂廷國際有限公司

香港九龍紅磡

民裕街 41 號

凱旋工商中心一萬 1 樓 A3 室



[11] 2423005.6

[15] 22-03-2024

[51] Cl. 11-01

[54] 手鐲

Bangle

[73] 蒂廷國際有限公司

香港九龍紅磡

民裕街 41 號

凱旋工商中心一期 1 樓 A3 室

[74] 蒂廷國際有限公司

香港九龍紅磡

民裕街 41 號

凱旋工商中心一萬 1 樓 A3 室



[11] 2423021.9M001

[15] 22-03-2024

[30] 27-10-2023 / CA, AM, AZ, BZ, BA, GE, LI, MK, MD, MC, MN, ME, MA, NO, OM, SG, CH, TN, TR, UA, GB, EU, AL, KG / DM/233012

[51] Cl. 11-01

[54] 耳環

Earrings

[73] Harry Winston SA

Chemin du Tourbillon 8,

CH-1228 Plan-les-Ouates,
Switzerland

[74] SPRUSON & FERGUSON (HONG KONG) LIMITED
5001 Hopewell Centre,
183 Queen's Road East,
Wan Chai, Hong Kong



[11] 2423021.9M002

[15] 22-03-2024

[30] 27-10-2023 / CA, AM, AZ, BZ, BA, GE, LI, MK, MD, MC, MN, ME,
MA, NO, OM, SG, CH, TN, TR, UA, GB, EU, AL, KG / DM/233012

[51] Cl. 11-01

[54] 項鍊

Necklace

[73] Harry Winston SA
Chemin du Tourbillon 8,
CH-1228 Plan-les-Ouates,
Switzerland

[74] SPRUSON & FERGUSON (HONG KONG) LIMITED
5001 Hopewell Centre,
183 Queen's Road East,
Wan Chai, Hong Kong



[11] 2423021.9M003

[15] 22-03-2024

[30] 27-10-2023 / CA, AM, AZ, BZ, BA, GE, LI, MK, MD, MC, MN, ME, MA, NO, OM, SG, CH, TN, TR, UA, GB, EU, AL, KG / DM/233012

[51] Cl. 11-01

[54] 項鍊

Necklace

[73] Harry Winston SA

Chemin du Tourbillon 8,
CH-1228 Plan-les-Ouates,
Switzerland

[74] SPRUSON & FERGUSON (HONG KONG) LIMITED

5001 Hopewell Centre,
183 Queen's Road East,
Wan Chai, Hong Kong



[11] 2423024.5M001

[15] 25-03-2024

[30] 27-09-2023 / EU / 015035268-0001

[51] Cl. 12-08

[54] 汽車

Automobile

[73] Dr. Ing. h.c. F. Porsche Aktiengesellschaft

Porscheplatz 1,

70435 Stuttgart,
Germany

[74] WENPING PATENT & TRADE MARK AGENT LIMITED
1701 Tung Wai Commercial Building,
111 Gloucester Road,
Hong Kong



[11] 2423024.5M002

[15] 25-03-2024

[30] 27-09-2023 / EU / 015035268-0007

[51] Cl. 12-16

[54] 汽車車身板
Vehicle body panel

[73] Dr. Ing. h.c. F. Porsche Aktiengesellschaft
Porscheplatz 1,
70435 Stuttgart,
Germany

[74] WENPING PATENT & TRADE MARK AGENT LIMITED
1701 Tung Wai Commercial Building,
111 Gloucester Road,
Hong Kong



[11] 2423024.5M003

[15] 25-03-2024

[30] 27-09-2023 / EU / 015035268-0030

[51] Cl. 12-16

[54] 汽車車身板
Vehicle body panel

[73] Dr. Ing. h.c. F. Porsche Aktiengesellschaft
Porscheplatz 1,
70435 Stuttgart,
Germany

[74] WENPING PATENT & TRADE MARK AGENT LIMITED
1701 Tung Wai Commercial Building,
111 Gloucester Road,
Hong Kong



[11] 2423024.5M004

[15] 25-03-2024

[30] 27-09-2023 / EU / 015035268-0034

[51] Cl. 12-16

[54] 汽車車身板
Vehicle body panel

[73] Dr. Ing. h.c. F. Porsche Aktiengesellschaft
Porscheplatz 1,
70435 Stuttgart,
Germany

[74] WENPING PATENT & TRADE MARK AGENT LIMITED
1701 Tung Wai Commercial Building,
111 Gloucester Road,
Hong Kong



[11] 2423024.5M005

[15] 25-03-2024

[30] 27-09-2023 / EU / 015035268-0037

[51] Cl. 12-16

[54] 汽車車身板

Vehicle body panel

[73] Dr. Ing. h.c. F. Porsche Aktiengesellschaft

Porscheplatz 1,

70435 Stuttgart,

Germany

[74] WENPING PATENT & TRADE MARK AGENT LIMITED

1701 Tung Wai Commercial Building,

111 Gloucester Road,

Hong Kong



[11] 2423024.5M006

[15] 25-03-2024

[30] 27-09-2023 / EU / 015035268-0040

[51] Cl. 12-16

[54] 汽車車身板

Vehicle body panel

[73] Dr. Ing. h.c. F. Porsche Aktiengesellschaft

Porscheplatz 1,
70435 Stuttgart,
Germany

[74] WENPING PATENT & TRADE MARK AGENT LIMITED

1701 Tung Wai Commercial Building,
111 Gloucester Road,
Hong Kong

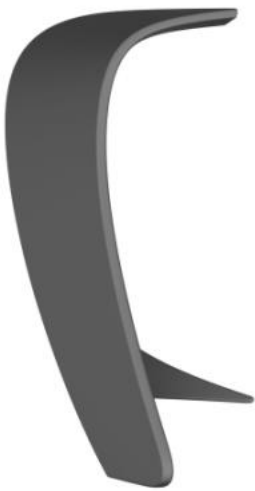

[11] 2423024.5M007

[15] 25-03-2024

[30] 27-09-2023 / EU / 015035268-0057

[51] Cl. 12-16

[54] 汽車擾流板

Spoiler for vehicles

[73] Dr. Ing. h.c. F. Porsche Aktiengesellschaft

Porscheplatz 1,
70435 Stuttgart,
Germany

[74] WENPING PATENT & TRADE MARK AGENT LIMITED

1701 Tung Wai Commercial Building,
111 Gloucester Road,
Hong Kong





香港特別行政區政府知識產權署外觀設計註冊處

The Government of the Hong Kong Special Administrative Region

Designs Registry, Intellectual Property Department

根據註冊外觀設計條例第 28 條，下列註冊外觀設計因未繳續期費而停止有效。

各組記項按註冊外觀設計停止有效日期及註冊編號先後次序排列。

Registered designs ceased through non-payment of renewal fees under section 28 of the Registered Designs Ordinance. Entries are listed below under their expiry dates.

28-03-2024 - 03-04-2024

28-03-2024	1913343.2M007	1913359.6M002
1913327.9	1913343.2M008	1913359.6M003
1913331.7	1913343.2M009	1913359.6M004
	1913343.2M010	1913359.6M005
30-03-2024	1913343.2M011	1913359.6M006
0900504.8	1913343.2M012	1913362.2
	1913344.4M001	1913364.6
31-03-2024	1913344.4M002	1913365.9
0410719.1	1913344.4M003	1913366.1
0410723.9	1913344.4M004	1913367.3
0900505.1M001	1913344.4M005	1913368.5
0900505.1M002	1913345.7	1913369.7
0900508.7	1913346.9	1913370.9
0900509.9	1913350.7	1913371.1
0900515.2	1913351.9	1913377.4M001
1400581.7	1913354.5	1913377.4M002
1400583.1		1913378.6
1400584.3	02-04-2024	1913379.8M001
1400585.6	1913355.8	1913379.8M002
1400588.2	1913356.0	1913380.0M001
1913332.9	1913357.2M001	1913380.0M002
1913341.8	1913357.2M002	1913381.2
	1913357.2M003	
01-04-2024	1913357.2M004	03-04-2024
1400592.0	1913357.2M005	1400600.9
1400593.2	1913357.2M006	1400604.7M003
1400595.7	1913357.2M007	1400604.7M009
1400596.9	1913357.2M008	1400605.0M001
1913343.2M001	1913358.4M001	1400605.0M002
1913343.2M002	1913358.4M002	1400605.0M003
1913343.2M003	1913358.4M003	1400605.0M004
1913343.2M004	1913358.4M004	1400605.0M005
1913343.2M005	1913358.4M005	1400606.2M001
1913343.2M006	1913359.6M001	1400606.2M002

1400606.2M003
1400606.2M004
1400606.2M005
1400606.2M006
1400606.2M007
1400609.8



香港特別行政區政府知識產權署外觀設計註冊處

The Government of the Hong Kong Special Administrative Region

Designs Registry, Intellectual Property Department

根據註冊外觀設計規則第 31 條刪除的註冊外觀設計。各組記項按註冊外觀設計刪除日期及註冊編號先後次序排列。

Registered designs removed under section 31 of the Registered Designs Rules. Entries are listed below under their removal dates.

05-04-2024 - 11-04-2024**05-04-2024**

0802364.0	1801991.1M001
0802366.5	1801991.1M002
0802367.7	1801994.7M001
1301677.1	1801994.7M002
1301678.3	1801994.7M003
1301679.5	1801995.0

10-04-2024**06-04-2024**

0802381.6	0802409.7M001
0802382.8	0802419.8M003
0802384.2	1301723.9M001
0802386.7	1301723.9M002
1301683.3	1301725.4
1301684.5	1400803.9
1301685.8	1801854.1
1301686.0	1801997.4
1301691.0	1802000.2
1301695.9	1802002.6
1301696.1M002	1802003.8

11-04-2024

1801988.5	1301741.7
1801989.7	1301743.1
1801990.9	

09-04-2024

0802401.0
0802402.2
1301700.1
1301715.3M001
1301715.3M002
1301715.3M003
1301715.3M004
1301715.3M005
1301715.3M006



香港特別行政區政府知識產權署外觀設計註冊處

The Government of the Hong Kong Special Administrative Region

Designs Registry, Intellectual Property Department

根據註冊外觀設計條例第 67 及 76 條，更正註冊紀錄冊內及已提交文件中的錯誤

Correction of errors in register and in filed documents under sections 67 and 76 of the Registered Designs Ordinance

下列在 02.02.2024 官方公報刊登的更正錯誤的請求已在 03.04.2024 獲准許

The following request for correction of error advertised in the official journal on 02.02.2024 was allowed on 03.04.2024

[11] 2322310.0

[30] 29-05-2023