

# 香港知識產權公報

Hong Kong Intellectual Property Journal

2024年7月26日

26 July 2024



## 目錄 Contents

### 根據註冊外觀設計條例第 25 條註冊的外觀設計

#### **Designs Registered under section 25 of the Registered Designs Ordinance**

按註冊編號排列

Arranged by Registration Number

### 根據註冊外觀設計條例(第 522 章)公布的其他公告

#### **Other Notices Published under the Registered Designs Ordinance (Cap. 522)**

根據註冊外觀設計條例第 28 條，註冊外觀設計因未繳續期費而停止有效

Registered designs ceased through non-payment of renewal fees under section 28 of the Registered Designs Ordinance

根據註冊外觀設計規則第 31 條刪除的註冊外觀設計

Registered designs removed under section 31 of the Registered Designs Rules

根據註冊外觀設計條例第 76 條，更正已提交文件中的錯誤

Correction of errors in filed documents under section 76 of the Registered Designs Ordinance

### 以下事項沒有記錄

#### **No Records for the Following Matters**

根據註冊外觀設計條例第 30 條放棄的外觀設計的註冊

Surrender of Registration of Design under section 30 of the Registered Designs Ordinance

根據註冊外觀設計規則第 37 條，向處長作出轉介

Reference to Registrar under section 37 of the Registered Designs Rules

根據註冊外觀設計條例第 45 條，撤銷註冊

Revocation of Registration under section 45 of the Registered Designs Ordinance

根據註冊外觀設計規則第 46 條，向法院作出轉介

Reference to Court under section 46 of the Registered Designs Rules

根據註冊外觀設計規則第 63 條對不符合規定之處作出糾正

Rectification of Irregularities under section 63 of the Registered Designs Rules

根據註冊外觀設計條例第 66 條，糾正註冊紀錄冊

Rectification of Register under section 66 of the Registered Designs Ordinance

根據註冊外觀設計條例第 67 條 更正註冊紀錄冊內的錯誤

Correction of errors in Register under section 67 of the Registered Designs Ordinance

根據註冊外觀設計條例第 67 及 76 條，更正註冊紀錄冊內及已提交文件中的錯誤

Correction of Errors in Register and in Filed Documents under sections 67 and 76 of the Registered Designs Ordinance

勘誤

Corrigendum

## 註冊外觀設計公告註釋

### Notes on advertisements of registration of designs

方括號表示下列資料：

Square brackets indicate the following data：

[11] 註冊編號 Registration number / 聯合王國註冊編號 United Kingdom registration number

[15] 註冊日期 Registration date / 當作註冊日期 Deemed registration date / 聯合王國註冊日期 United Kingdom registration date

[17] 註冊有效期屆滿日期 Expiry date of the period of registration

[22] 提交日期 Filing date / 當作提交日期 Deemed filing date / 聯合王國提交日期 United Kingdom filing date

[30] 聲稱享有的優先權（提交日期 / 巴黎公約國或世界貿易組織成員 / 申請編號） Priority claimed (filing date / Paris Convention country or WTO member / application number)

[51] 國際外觀設計分類號（洛迦諾分類號） International Classification of designs (Locarno Classification)

[54] 物品 Article

[55] 外觀設計的表述 Representation of the design

[62] 分開前的申請編號及提交日期 Application number before division and filing date

[66] 過往註冊的聯繫外觀設計註冊編號 / 日期 Registration No. / Date of Previous Registration for Association

[72] 設計人 Designer

[73] 擁有人姓名和地址 Name and address of the owner

[74] 代理人 Agent / 送達地址 Address for service



香港特別行政區政府知識產權署外觀設計註冊處  
The Government of the Hong Kong Special Administrative Region  
Designs Registry, Intellectual Property Department

## 根據註冊外觀設計條例第 25 條註冊的外觀設計

### Designs registered under section 25 of the Registered Designs Ordinance

按註冊編號排列

Arranged by Registration Number

[11] 2422701.1M001

[15] 17-01-2024

[30] 25-07-2023 / CN / 2023304680818

[51] Cl. 4-02

[54] 牙刷

Toothbrush

[73] 好來化工(中山)有限公司

HAWLEY & HAZEL CHEMICAL COMPANY (ZHONGSHAN) LIMITED

中國

廣東省中山市

西區沙朗第三工業區金昌工業路 22 號

[74] 萬慧達(亞太)諮詢有限公司

香港灣仔

港灣道 18 號

中環廣場 1903 室



[11] 2422701.1M002

[15] 17-01-2024

[30] 25-07-2023 / CN / 2023304680818

[51] Cl. 4-02

[54] 牙刷

Toothbrush

[73] 好來化工(中山)有限公司

HAWLEY & HAZEL CHEMICAL COMPANY (ZHONGSHAN) LIMITED

中國

廣東省中山市

西區沙朗第三工業區金昌工業路 22 號

[74] 萬慧達(亞太)諮詢有限公司

香港灣仔

港灣道 18 號

中環廣場 1903 室



[11] 2422894.8

[15] 06-03-2024

[30] 14-12-2023 / CN / 2023308243181

[51] Cl. 4-02

[54] 牙刷

Toothbrush

[73] 好來化工(中山)有限公司

HAWLEY & HAZEL CHEMICAL COMPANY (ZHONGSHAN) LIMITED

中國

廣東省中山市

西區沙朗第三工業區金昌工業路 22 號

[74] 萬慧達(亞太)諮詢有限公司

香港灣仔

港灣道 18 號  
中環廣場 1903 室



---

[11] 2422955.9M001

[15] 14-03-2024

[30] 21-12-2023 / EU / 015045264-0001

[51] Cl. 9-01

[54] 香水用的容器

Container for perfume

[73] DIPTYQUE S.A.S.

34, boulevard Saint Germain,

F-75005 Paris,

France

[74] ECCLES & LEE

Suite 3212, Jardine House,

1 Connaught Place,

Central, Hong Kong



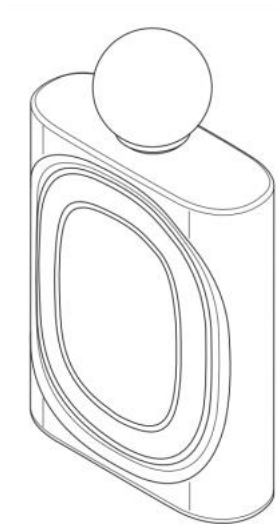

---

[11] 2422955.9M002

[15] 14-03-2024

[30] 21-12-2023 / EU / 015045264-0002

[51] Cl. 9-01

[54] 香水用的容器

Container for perfume

[73] DIPTYQUE S.A.S.

34, boulevard Saint Germain,

F-75005 Paris,

France

[74] ECCLES & LEE

Suite 3212, Jardine House,

1 Connaught Place,

Central, Hong Kong

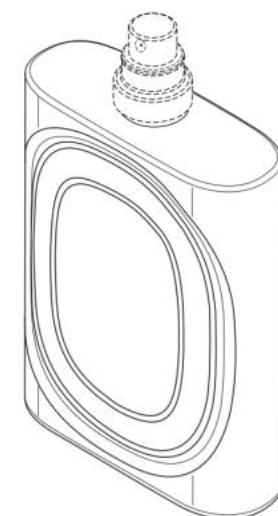

[11] 2422997.7M001

[15] 22-03-2024

[30] 25-09-2023 / US / 29/912,837

[51] Cl. 24-02

[54] 手持式藥物遞送裝置

Handheld drug delivery device

[73] Amgen Inc.

One Amgen Center Drive,  
Thousand Oaks, California 91320-1799,  
United States of America

[74] CHINA PATENT AGENT (HONG KONG) LIMITED

22/F, Great Eagle Centre,  
23 Harbour Road,  
Wanchai, Hong Kong

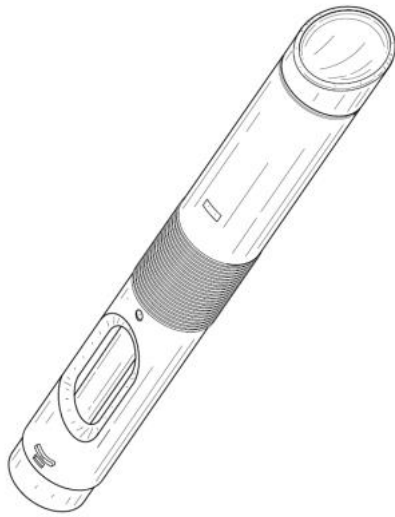

---

[11] 2422997.7M002

[15] 22-03-2024

[30] 25-09-2023 / US / 29/912,837

[51] Cl. 24-02

[54] 手持式藥物遞送裝置

Handheld drug delivery device

[73] Amgen Inc.

One Amgen Center Drive,  
Thousand Oaks, California 91320-1799,  
United States of America

[74] CHINA PATENT AGENT (HONG KONG) LIMITED

22/F, Great Eagle Centre,  
23 Harbour Road,  
Wanchai, Hong Kong

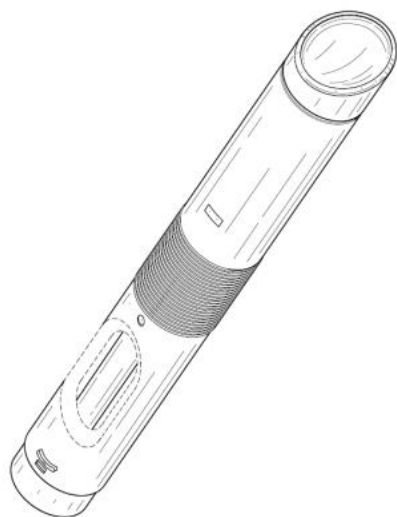

---

[11] 2422997.7M003

[15] 22-03-2024

[30] 25-09-2023 / US / 29/912,837

[51] Cl. 24-02

[54] 手持式藥物遞送裝置

Handheld drug delivery device

[73] Amgen Inc.

One Amgen Center Drive,  
Thousand Oaks, California 91320-1799,  
United States of America

[74] CHINA PATENT AGENT (HONG KONG) LIMITED

22/F, Great Eagle Centre,  
23 Harbour Road,  
Wanchai, Hong Kong

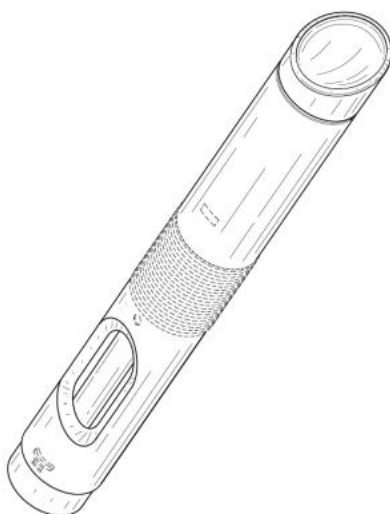

[11] 2422997.7M004

[15] 22-03-2024

[30] 25-09-2023 / US / 29/912,837

[51] C1. 24-02

[54] 手持式藥物遞送裝置

Handheld drug delivery device

[73] Amgen Inc.

One Amgen Center Drive,  
Thousand Oaks, California 91320-1799,  
United States of America

[74] CHINA PATENT AGENT (HONG KONG) LIMITED

22/F, Great Eagle Centre,  
23 Harbour Road,  
Wanchai, Hong Kong

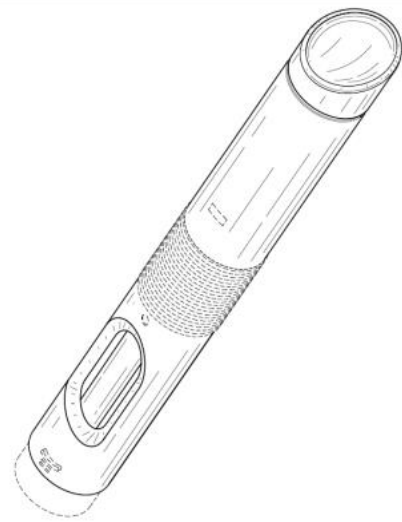

[11] 2422997.7M005

[15] 22-03-2024

[30] 25-09-2023 / US / 29/912,837

[51] C1. 24-02

[54] 手持式藥物遞送裝置

Handheld drug delivery device

[73] Amgen Inc.

One Amgen Center Drive,  
Thousand Oaks, California 91320-1799,  
United States of America

[74] CHINA PATENT AGENT (HONG KONG) LIMITED

22/F, Great Eagle Centre,  
23 Harbour Road,  
Wanchai, Hong Kong

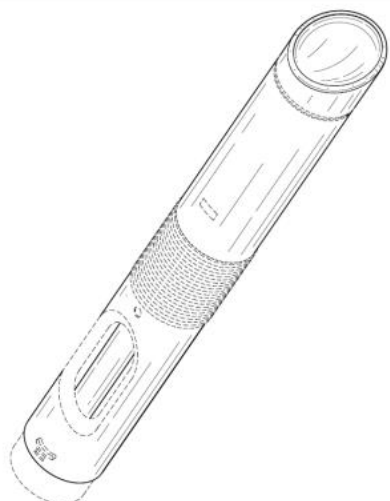

---

[11] 2422998.9M001

[15] 22-03-2024

[30] 25-09-2023 / US / 29/912,835

[51] Cl. 24-02

[54] 手持式藥物輸送裝置

Handheld drug delivery device

[73] Amgen Inc.

One Amgen Center Drive,  
Thousand Oaks, California 91320-1799,  
United States of America

[74] CHINA PATENT AGENT (HONG KONG) LIMITED

22/F, Great Eagle Centre,  
23 Harbour Road,  
Wanchai, Hong Kong

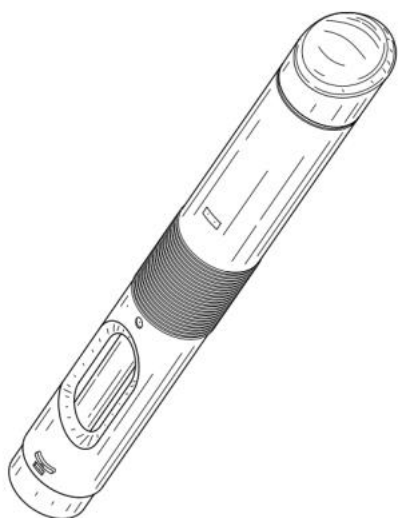

[11] 2422998.9M002

[15] 22-03-2024

[30] 25-09-2023 / US / 29/912,835

[51] C1. 24-02

[54] 手持式藥物輸送裝置

Handheld drug delivery device

[73] Amgen Inc.

One Amgen Center Drive,  
Thousand Oaks, California 91320-1799,  
United States of America

[74] CHINA PATENT AGENT (HONG KONG) LIMITED

22/F, Great Eagle Centre,  
23 Harbour Road,  
Wanchai, Hong Kong

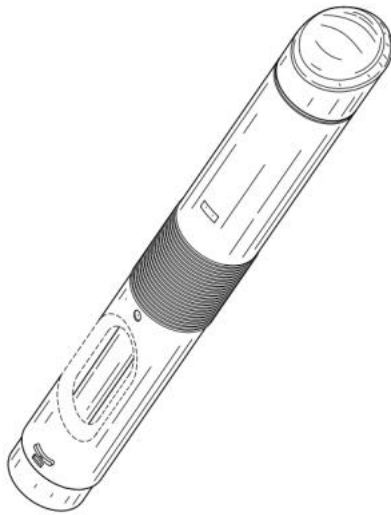

[11] 2422998.9M003

[15] 22-03-2024

[30] 25-09-2023 / US / 29/912,835

[51] C1. 24-02

[54] 手持式藥物輸送裝置

Handheld drug delivery device

[73] Amgen Inc.

One Amgen Center Drive,  
Thousand Oaks, California 91320-1799,  
United States of America

[74] CHINA PATENT AGENT (HONG KONG) LIMITED

22/F, Great Eagle Centre,  
23 Harbour Road,  
Wanchai, Hong Kong

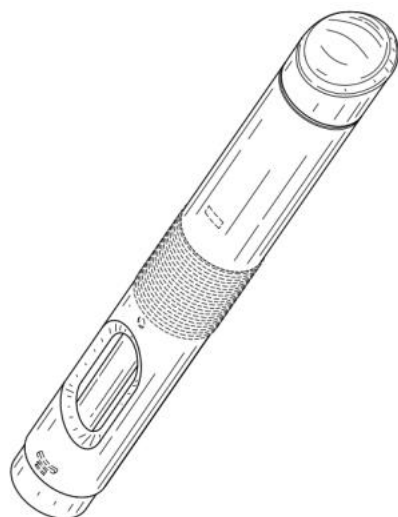

---

[11] 2422998.9M004

[15] 22-03-2024

[30] 25-09-2023 / US / 29/912,835

[51] Cl. 24-02

[54] 手持式藥物輸送裝置

Handheld drug delivery device

[73] Amgen Inc.

One Amgen Center Drive,  
Thousand Oaks, California 91320-1799,  
United States of America

[74] CHINA PATENT AGENT (HONG KONG) LIMITED

22/F, Great Eagle Centre,  
23 Harbour Road,  
Wanchai, Hong Kong

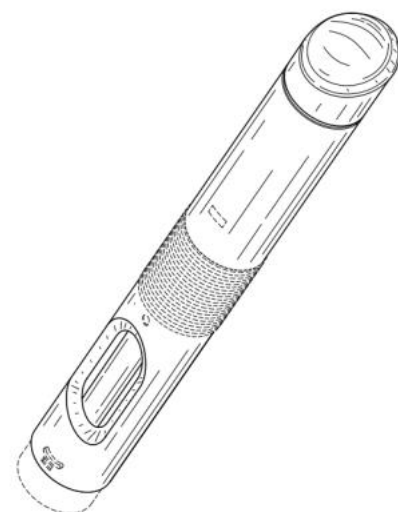

- [11] 2422998.9M005  
[15] 22-03-2024  
[30] 25-09-2023 / US / 29/912,835  
[51] Cl. 24-02  
[54] 手持式藥物輸送裝置  
Handheld drug delivery device  
[73] Amgen Inc.  
One Amgen Center Drive,  
Thousand Oaks, California 91320-1799,  
United States of America  
[74] CHINA PATENT AGENT (HONG KONG) LIMITED  
22/F, Great Eagle Centre,  
23 Harbour Road,  
Wanchai, Hong Kong

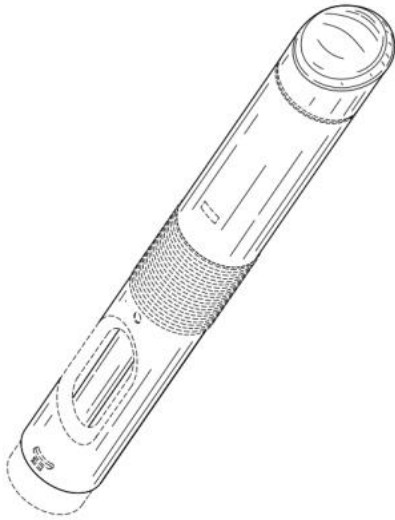

- 
- [11] 2423016.9  
[15] 22-03-2024  
[30] 22-09-2023 / JP / 2023-019460  
[51] Cl. 24-02  
[54] 醫學用瓶  
Bottle for medical purpose  
[73] 株式會社大塚製藥工場  
Otsuka Pharmaceutical Factory, Inc.  
115 Aza Kuguhara, Tateiwa, Muya-cho,  
Naruto-shi, Tokushima 772-8601,  
Japan  
[74] WILKINSON & GRIST  
6th Floor, Prince's Building,  
Chater Road,  
Central, Hong Kong



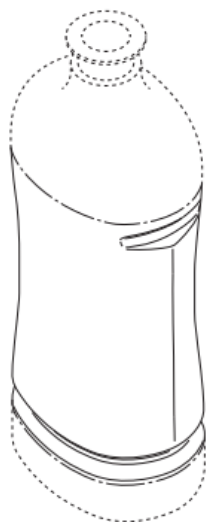

---

[11] 2423028.4M001

[15] 25-03-2024

[30] 25-09-2023 / US / 29/912,831

[51] Cl. 24-02

[54] 手持式給藥裝置

Handheld drug delivery device

[73] Amgen Inc.

One Amgen Center Drive,  
Thousand Oaks, California 91320-1799,  
United States of America

[74] CHINA PATENT AGENT (HONG KONG) LIMITED

22/F, Great Eagle Centre,  
23 Harbour Road,  
Wanchai, Hong Kong

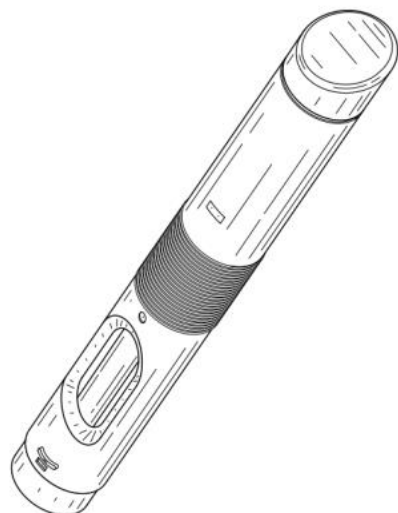

[11] 2423028.4M002

[15] 25-03-2024

[30] 25-09-2023 / US / 29/912,831

[51] C1. 24-02

[54] 手持式給藥裝置

Handheld drug delivery device

[73] Amgen Inc.

One Amgen Center Drive,  
Thousand Oaks, California 91320-1799,  
United States of America

[74] CHINA PATENT AGENT (HONG KONG) LIMITED

22/F, Great Eagle Centre,  
23 Harbour Road,  
Wanchai, Hong Kong

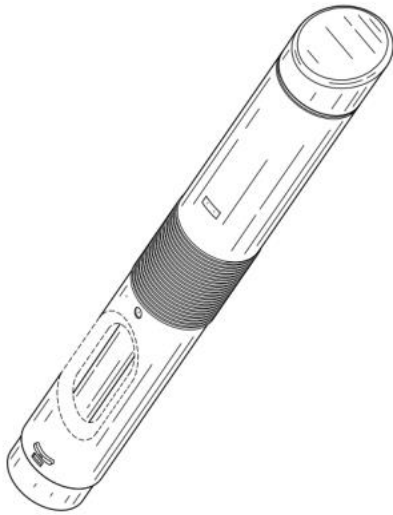

[11] 2423028.4M003

[15] 25-03-2024

[30] 25-09-2023 / US / 29/912,831

[51] C1. 24-02

[54] 手持式給藥裝置

Handheld drug delivery device

[73] Amgen Inc.

One Amgen Center Drive,  
Thousand Oaks, California 91320-1799,  
United States of America

[74] CHINA PATENT AGENT (HONG KONG) LIMITED

22/F, Great Eagle Centre,  
23 Harbour Road,  
Wanchai, Hong Kong

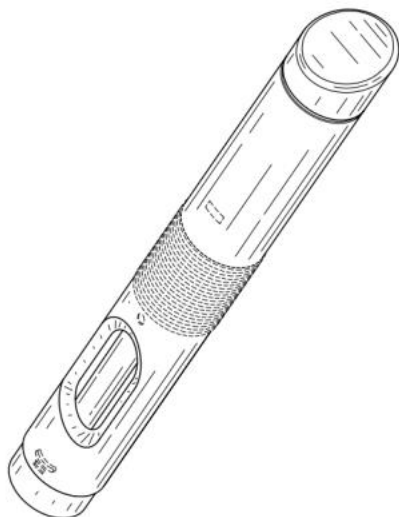

---

[11] 2423028.4M004

[15] 25-03-2024

[30] 25-09-2023 / US / 29/912,831

[51] Cl. 24-02

[54] 手持式給藥裝置

Handheld drug delivery device

[73] Amgen Inc.

One Amgen Center Drive,  
Thousand Oaks, California 91320-1799,  
United States of America

[74] CHINA PATENT AGENT (HONG KONG) LIMITED

22/F, Great Eagle Centre,  
23 Harbour Road,  
Wanchai, Hong Kong

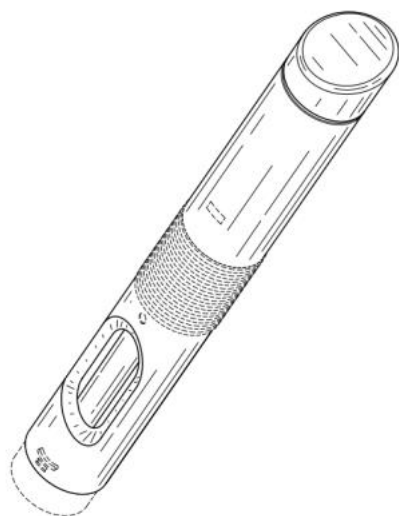

- [11] 2423028.4M005  
[15] 25-03-2024  
[30] 25-09-2023 / US / 29/912,831  
[51] C1. 24-02  
[54] 手持式給藥裝置  
Handheld drug delivery device  
[73] Amgen Inc.  
One Amgen Center Drive,  
Thousand Oaks, California 91320-1799,  
United States of America  
[74] CHINA PATENT AGENT (HONG KONG) LIMITED  
22/F, Great Eagle Centre,  
23 Harbour Road,  
Wanchai, Hong Kong

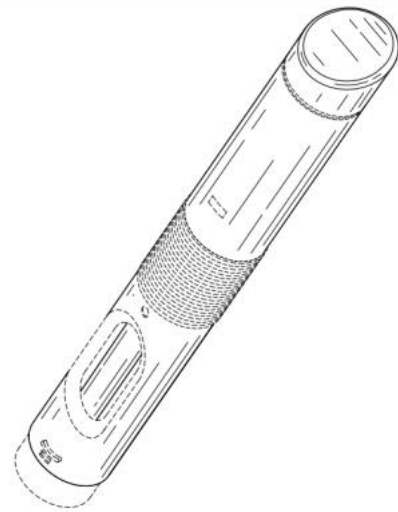

- 
- [11] 2423046.2  
[15] 27-03-2024  
[30] 25-12-2023 / CN / 2023308508093  
[51] C1. 3-01  
[54] 手機殼的背板  
Back panel of phone case  
[73] 深圳市殼邦科技有限公司  
Shenzhen Casebang Technology Co., Ltd.  
中國  
廣東省深圳市龍崗區阪田街道  
阪田創意產業園 Y3 棟 4 樓 08  
[74] 智享國際智慧財產權投顧有限公司 (WShare International IP Investment &  
Consultants Limited)  
香港

九龍觀塘道 348

宏利廣場 6 樓



---

[11] 2423047.4

[15] 27-03-2024

[30] 27-09-2023 / FR / 20234090

[51] Cl. 3-01

[54] 袋

Bag

[73] LOUIS VUITTON MALLETIER

2 rue du Pont-Neuf,

75001 Paris,

France

[74] BAKER & MCKENZIE

14th Floor, One Taikoo Place,

979 King's Road,

Quarry Bay, Hong Kong

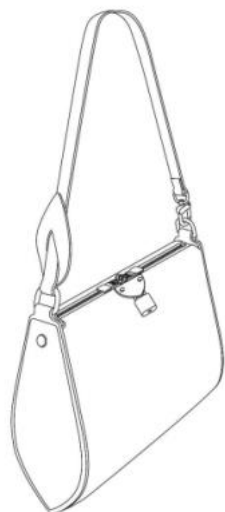

---

[11] 2423057.5

[15] 28-03-2024

[30] 28-09-2023 / US / 29/913,260

[51] Cl. 13-03

[54] 電連接器

Electronic connector

[73] KPR U.S., LLC

777 WEST STREET,

MANSFIELD, MA 02048,

UNITED STATES OF AMERICA

[74] CHINA PATENT AGENT (HONG KONG) LIMITED

22/F, Great Eagle Centre, 23 Harbour Road,

Wanchai,

Hong Kong

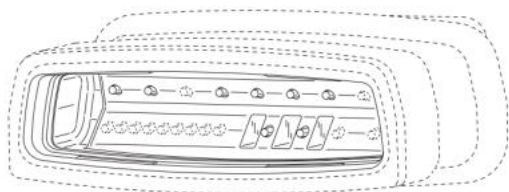

---

[11] 2423063.7

[15] 02-04-2024

[30] 05-10-2023 / FR / 20234220

[51] Cl. 3-01

[54] 袋

Bag

[73] LOUIS VUITTON MALLETIER  
2 rue du Pont-Neuf,  
75001 Paris,  
France

[74] BAKER & MCKENZIE  
14TH FLOOR, ONE TAIKOO PLACE,  
979 KING'S ROAD, QUARRY BAY,  
HONG KONG

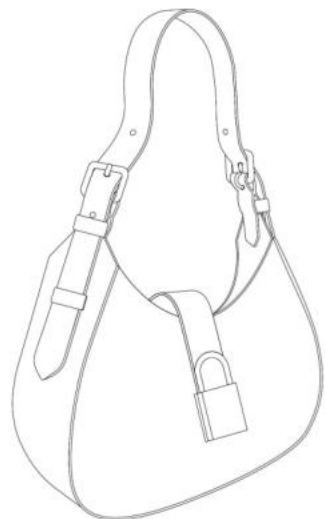

---

[11] 2423065.2

[15] 02-04-2024

[30] 05-10-2023 / FR / 20234233

[51] Cl. 3-01

[54] 袋  
Bag

[73] LOUIS VUITTON MALLETIER  
2 rue du Pont-Neuf,  
75001 Paris,  
France

[74] BAKER & MCKENZIE  
14TH FLOOR, ONE TAIKOO PLACE,  
979 KING'S ROAD, QUARRY BAY,  
HONG KONG

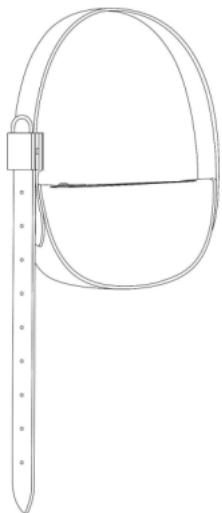

---

[11] 2423067.6

[15] 02-04-2024

[30] 30-11-2023 / FR / 20235129

[51] Cl. 3-01

[54] 袋

Bag

[73] LOUIS VUITTON MALLETIER

2 rue du Pont-Neuf,

75001 Paris,

France

[74] BAKER & MCKENZIE

14TH FLOOR, ONE TAIKOO PLACE,

979 KING'S ROAD, QUARRY BAY,

HONG KONG





- [11] 2423122.3M001
- [15] 12-04-2024
- [30] 24-10-2023 / US / 29/915,003
- [51] Cl. 4-02
- [54] 個人護理用具  
Personal care implement
- [73] 高露潔-棕欖公司  
COLGATE-PALMOLIVE COMPANY  
300 Park Avenue, New York, New York 10022,  
United States of America
- [74] UNITALEN ATTORNEYS AT LAW LIMITED  
Unit No.1211, Level 12, Tower 1,  
Grand Century Place,  
193 Prince Edward Road West,  
Mongkok, Kowloon, Hong Kong



- 
- [11] 2423122.3M002
- [15] 12-04-2024
- [30] 24-10-2023 / US / 29/915,003
- [51] Cl. 4-02
- [54] 個人護理用具  
Personal care implement
- [73] 高露潔-棕欖公司  
COLGATE-PALMOLIVE COMPANY  
300 Park Avenue, New York, New York 10022,  
United States of America
- [74] UNITALEN ATTORNEYS AT LAW LIMITED  
Unit No.1211, Level 12, Tower 1,  
Grand Century Place,

193 Prince Edward Road West,  
Mongkok, Kowloon, Hong Kong



---

[11] 2423122.3M003

[15] 12-04-2024

[30] 24-10-2023 / US / 29/915,003

[51] Cl. 4-02

[54] 個人護理用具

Personal care implement

[73] 高露洁-棕欖公司

COLGATE-PALMOLIVE COMPANY

300 Park Avenue, New York, New York 10022,

United States of America

[74] UNITALEN ATTORNEYS AT LAW LIMITED

Unit No.1211, Level 12, Tower 1,

Grand Century Place,

193 Prince Edward Road West,

Mongkok, Kowloon, Hong Kong



---

[11] 2423124.7M001

[15] 12-04-2024

[30] 30-11-2023 / CN / 2023307896231

[51] Cl. 14-04

[54] 電子設備的電商購物圖形用戶界面的湊單島界面

Add-on item island interface of e-commerce shopping graphical  
user interface of electronic device

[73] 杭州阿里巴巴海外互联网产业有限公司

Hangzhou Alibaba International Internet Industry Co., Ltd.

中國

310056 浙江省杭州市滨江区长河街道

网商路 699 号 5 号楼 3 楼 303 室

[74] 三友知識產權代理有限公司

香港

德輔道中 188 號

金龍中心 23 樓 2301 室



[11] 2423124.7M002

[15] 12-04-2024

[30] 30-11-2023 / CN / 2023307896231

[51] Cl. 14-04

[54] 電子設備的電商購物圖形用戶界面的湊單島界面

Add-on item island interface of e-commerce shopping graphical user interface of electronic device

[73] 杭州阿里巴巴海外互联网产业有限公司

Hangzhou Alibaba International Internet Industry Co., Ltd.

中國

310056 浙江省杭州市滨江区长河街道

网商路 699 号 5 号楼 3 楼 303 室

[74] 三友知識產權代理有限公司

香港

德輔道中 188 號

金龍中心 23 樓 2301 室



[11] 2423124.7M003

[15] 12-04-2024

[30] 30-11-2023 / CN / 2023307896231

[51] Cl. 14-04

[54] 電子設備的電商購物圖形用戶界面的湊單島界面

Add-on item island interface of e-commerce shopping graphical user interface of electronic device

[73] 杭州阿里巴巴海外互联网产业有限公司

Hangzhou Alibaba International Internet Industry Co., Ltd.

中國

310056 浙江省杭州市滨江区长河街道

网商路 699 号 5 号楼 3 楼 303 室

[74] 三友知識產權代理有限公司

香港

德輔道中 188 號

金龍中心 23 樓 2301 室



[11] 2423124.7M004

[15] 12-04-2024

[30] 30-11-2023 / CN / 2023307896231

[51] Cl. 14-04

[54] 電子設備的電商購物圖形用戶界面的湊單島界面

Add-on item island interface of e-commerce shopping graphical user interface of electronic device

[73] 杭州阿里巴巴海外互联网产业有限公司

Hangzhou Alibaba International Internet Industry Co., Ltd.

中國

310056 浙江省杭州市滨江区长河街道

网商路 699 号 5 号楼 3 楼 303 室

[74] 三友知識產權代理有限公司

香港

德輔道中 188 號

金龍中心 23 樓 2301 室



[11] 2423124.7M005

[15] 12-04-2024

[30] 30-11-2023 / CN / 2023307896231

[51] Cl. 14-04

[54] 電子設備的電商購物圖形用戶界面的湊單島界面

Add-on item island interface of e-commerce shopping graphical user interface of electronic device

[73] 杭州阿里巴巴海外互联网产业有限公司

Hangzhou Alibaba International Internet Industry Co., Ltd.

中國

310056 浙江省杭州市滨江区长河街道

网商路 699 号 5 号楼 3 楼 303 室

[74] 三友知識產權代理有限公司

香港

德輔道中 188 號

金龍中心 23 樓 2301 室



[11] 2423124.7M006

[15] 12-04-2024

[30] 30-11-2023 / CN / 2023307896231

[51] C1. 14-04

[54] 電子設備的電商購物圖形用戶界面的湊單島界面

Add-on item island interface of e-commerce shopping graphical user interface of electronic device

[73] 杭州阿里巴巴海外互联网产业有限公司

Hangzhou Alibaba International Internet Industry Co., Ltd.

中國

310056 浙江省杭州市滨江区长河街道

网商路 699 号 5 号楼 3 楼 303 室

[74] 三友知識產權代理有限公司

香港

德輔道中 188 號

金龍中心 23 樓 2301 室





[11] 2423124.7M007

[15] 12-04-2024

[30] 30-11-2023 / CN / 2023307896231

[51] Cl. 14-04

[54] 電子設備的電商購物圖形用戶界面的湊單島界面

Add-on item island interface of e-commerce shopping graphical user interface of electronic device

[73] 杭州阿里巴巴海外互联网产业有限公司

Hangzhou Alibaba International Internet Industry Co., Ltd.

中國

310056 浙江省杭州市滨江区长河街道

网商路 699 号 5 号楼 3 楼 303 室

[74] 三友知識產權代理有限公司

香港

德輔道中 188 號

金龍中心 23 樓 2301 室



[11] 2423124.7M008

[15] 12-04-2024

[30] 30-11-2023 / CN / 2023307896231

[51] Cl. 14-04

[54] 電子設備的電商購物圖形用戶界面的湊單島界面

Add-on item island interface of e-commerce shopping graphical user interface of electronic device

[73] 杭州阿里巴巴海外互联网产业有限公司

Hangzhou Alibaba International Internet Industry Co., Ltd.

中國

310056 浙江省杭州市滨江区长河街道

网商路 699 号 5 号楼 3 楼 303 室

[74] 三友知識產權代理有限公司

香港

德輔道中 188 號

金龍中心 23 樓 2301 室



[11] 2423124.7M009

[15] 12-04-2024

[30] 30-11-2023 / CN / 2023307896231

[51] Cl. 14-04

[54] 電子設備的電商購物圖形用戶界面的湊單島界面

Add-on item island interface of e-commerce shopping graphical user interface of electronic device

[73] 杭州阿里巴巴海外互联网产业有限公司

Hangzhou Alibaba International Internet Industry Co., Ltd.

中國

310056 浙江省杭州市滨江区长河街道

网商路 699 号 5 号楼 3 楼 303 室

[74] 三友知識產權代理有限公司

香港

德輔道中 188 號

金龍中心 23 樓 2301 室



[11] 2423124.7M010

[15] 12-04-2024

[30] 30-11-2023 / CN / 2023307896231

[51] Cl. 14-04

[54] 電子設備的電商購物圖形用戶界面的湊單島界面

Add-on item island interface of e-commerce shopping graphical user interface of electronic device

[73] 杭州阿里巴巴海外互联网产业有限公司

Hangzhou Alibaba International Internet Industry Co., Ltd.

中國

310056 浙江省杭州市滨江区长河街道

网商路 699 号 5 号楼 3 楼 303 室

[74] 三友知識產權代理有限公司

香港

德輔道中 188 號

金龍中心 23 樓 2301 室



[11] 2423130.0

[15] 15-04-2024

[30] 26-02-2024 / CA, CN, RU, SG, CH, GB, EU, JP, KR / DM/235885

[51] Cl. 10-02

[54] 腕錶

Wristwatches

[73] Cartier International AG

Hinterbergstrasse 22,

6312 Steinhausen,

Switzerland

[74] ATL LAW OFFICES

16/F., China Hong Kong Tower,

8-12 Hennessy Road, Wanchai,

Hong Kong

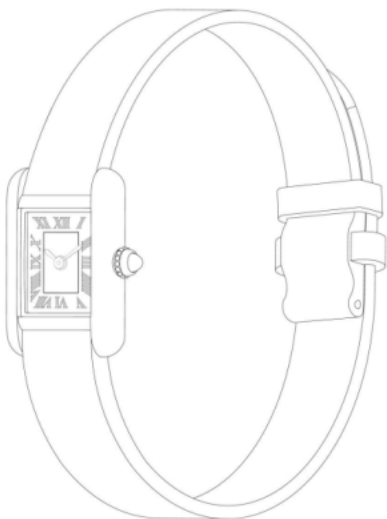

[11] 2423135.1

[15] 16-04-2024

[51] Cl. 25-02

[54] 注水水馬

Water barrier

[73] ADVANCE FORCE LTD T/A SAFEWELL COMPANY  
G/F, Unit N, International Industrial Centre,  
2-8 Kwei Tei Street, Fotan, New Territories,  
Hong Kong

[74] ADVANCE FORCE LTD T/A SAFEWELL COMPANY  
G/F, Unit N, International Industrial Centre,  
2-8 Kwei Tei Street, Fotan, New Territories,  
Hong Kong



---

[11] 2423137.5

[15] 16-04-2024

[51] Cl. 14-01

[54] 數字音頻播放器

Digital audio player

[73] Dreamus Company  
311, Gangnam-daero,  
Seocho-gu, Seoul, 06628,  
Republic of Korea

[74] HKIPA LIMITED  
Unit 230, 2/F, Building 12W,  
No. 12 Science Park West Avenue, Phase 3,  
Hong Kong Science Park, Pak Shek Kok,  
New Territories, Hong Kong

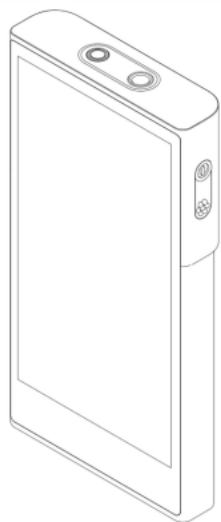

---

[11] 2423148.8

[15] 17-04-2024

[30] 20-10-2023 / SG, CH, TR, GB, EU / DM/232 753

[51] Cl. 10-07

[54] 錶面  
Dial

[73] HAMILTON INTERNATIONAL AG (HAMILTON INTERNATIONAL SA)  
(HAMILTON INTERNATIONAL LTD.)  
Länggasse 85,  
2504 Biel/Bienne,  
Switzerland

[74] SPRUSON & FERGUSON (HONG KONG) LIMITED  
5001 Hopewell Centre,  
183 Queen's Road East, Wan Chai,  
Hong Kong

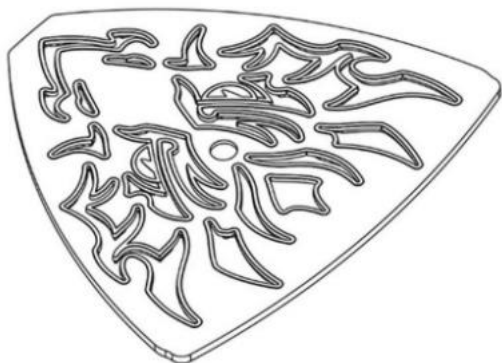

---

[11] 2423149.0

[15] 17-04-2024

[51] Cl. 11-01

[54] 首飾  
Jewellery

[73] QEELIN LIMITED  
FLAT/RM 05-08, 11/F, Harcourt House,  
39 Gloucester Road, WANCHAI,  
HONG KONG

[74] ELLALAN  
26th - 28th Floors, The Hennessy,  
256 Hennessy Road, Wanchai,  
Hong Kong



---

[11] 2423159.1

[15] 17-04-2024

[30] 09-04-2024 / CN / 2024301915892

[51] Cl. 9-03

[54] 包裝盒  
Packaging box

[73] 北京同仁堂國藥有限公司  
香港  
新界大埔工業邨大景街 3 號

[74] 中港知識產權有限公司  
香港  
灣仔告士打道 151 號資本中心 15 樓 1502 室





[11] 2423160.3

[15] 17-04-2024

[30] 09-04-2024 / CN / 202430191538X

[51] Cl. 9-03

[54] 包裝盒

Packaging box

[73] 北京同仁堂國藥有限公司

香港

新界大埔工業邨大景街 3 號

[74] 中港知識產權有限公司

香港

灣仔告士打道 151 號資本中心 15 樓 1502 室



- [11] 2423192.0  
[15] 23-04-2024  
[30] 27-10-2023 / EU / 015038473-0001  
[51] Cl. 21-01  
[54] 模型車  
Model car  
[73] Bugatti International S.A.  
412F route d'Esch,  
1030 Luxembourg,  
Luxembourg  
[74] WENPING PATENT & TRADE MARK AGENT LIMITED  
1701 Tung Wai Commercial Building,  
111 Gloucester Road,  
Hong Kong



- 
- [11] 2423201.1  
[15] 23-04-2024  
[30] 19-03-2024 / CN / 2024301419943  
[51] Cl. 9-03  
[54] 包裝盒  
Packaging box  
[73] 金致珠寶有限公司  
Zuri Jewelry Company Limited  
香港  
中環德輔道中 19 號環球大廈 2103 室  
[74] 卓遠知識產權有限公司  
香港  
上環禧利街 27 號  
富輝商業中心 10 樓



---

[11] 2423202.3

[15] 23-04-2024

[51] Cl. 13-03

[54] 電插座  
Electrical socket

[73] 金鋒企業集團有限公司  
Golden Edge Group Limited  
香港  
柴灣利眾街 20 號柴灣中心工業大廈 4 樓 B 室

[74] 卓遠知識產權有限公司  
香港  
上環禧利街 27 號  
富輝商業中心 10 樓

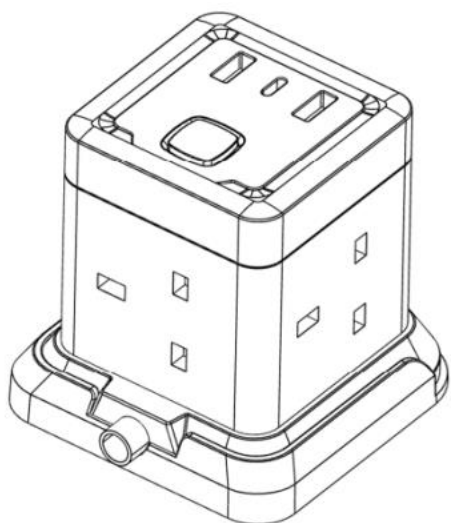

[11] 2423247.8

[15] 30-04-2024

[51] Cl. 13-02

[54] 充電櫃

Charging cabinet

[73] 香港奧特迅電力科技有限公司

HONG KONG AUTOSUN POWERTECH CO. LIMITED

BLK B-1, 8/F, BURLINGTON HSE,

90-94 NATHAN RD, TSIM SHA TSUI,

HONG KONG

[74] 海思国际知识产权有限公司

香港

九龍觀塘道 348 號

宏利廣場 6 樓



---

[11] 2423248.0

[15] 30-04-2024

[51] Cl. 13-02

[54] 充電樁

Charging pile

[73] 香港奧特迅電力科技有限公司

HONG KONG AUTOSUN POWERTECH CO. LIMITED

BLK B-1, 8/F, BURLINGTON HSE,

90-94 NATHAN RD, TSIM SHA TSUI,

HONG KONG

[74] 海思国际知识产权有限公司

香港

九龍觀塘道 348 號

宏利廣場 6 樓



---

[11] 2423249.2

[15] 30-04-2024

[51] Cl. 13-02

[54] 充電樁  
Charging pile

[73] 香港奧特迅電力科技有限公司  
HONG KONG AUTOSUN POWERTECH CO. LIMITED  
BLK B-1, 8/F, BURLINGTON HSE,  
90-94 NATHAN RD, TSIM SHA TSUI,  
HONG KONG

[74] 海思国际知识产权有限公司  
香港  
九龍觀塘道 348 號  
宏利廣場 6 樓



- [11] 2423251.6  
[15] 30-04-2024  
[30] 15-11-2023 / EU / 015041089-0001  
[51] Cl. 3-01  
[54] 行李袋  
Duffle bag  
[73] RIMOWA GmbH  
Richard-Byrd-Str. 13,  
50829 Cologne,  
Germany  
[74] ROBIN BRIDGE & JOHN LIU  
6th Floor, Emperor Commercial Centre,  
39 Des Voeux Road Central,  
Hong Kong



- 
- [11] 2423257.9M001  
[15] 30-04-2024  
[30] 31-10-2023 / US / US29/915,514  
[51] Cl. 11-01  
[54] 珠寶  
Jewellery  
[73] Raye Rocks LLC  
2600 S Douglas Rd, Ste 1008,  
Coral Gables, FL 33134,  
United States of America  
[74] LETTERS & THOO LIMITED  
Suite 1001-1003, 10/F, Prosperity Millennia Plaza,  
663 King's Road, Quarry Bay,  
Hong Kong



---

[11] 2423257.9M002

[15] 30-04-2024

[30] 31-10-2023 / US / US29/915,514

[51] Cl. 11-01

[54] 珠寶

Jewellery

[73] Raye Rocks LLC

2600 S Douglas Rd, Ste 1008,

Coral Gables, FL 33134,

United States of America

[74] LETTERS & THOO LIMITED

Suite 1001-1003, 10/F, Prosperity Millennia Plaza,

663 King's Road, Quarry Bay,

Hong Kong



- [11] 2423257.9M003
- [15] 30-04-2024
- [30] 31-10-2023 / US / US29/915,514
- [51] Cl. 11-01
- [54] 珠寶  
Jewellery
- [73] Raye Rocks LLC  
2600 S Douglas Rd, Ste 1008,  
Coral Gables, FL 33134,  
United States of America
- [74] LETTERS & THOO LIMITED  
Suite 1001-1003, 10/F, Prosperity Millennia Plaza,  
663 King's Road, Quarry Bay,  
Hong Kong

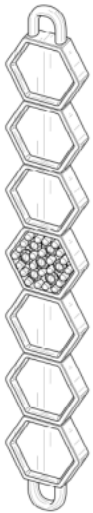

- 
- [11] 2423257.9M004
  - [15] 30-04-2024
  - [30] 31-10-2023 / US / US29/915,514
  - [51] Cl. 11-01
  - [54] 珠寶  
Jewellery
  - [73] Raye Rocks LLC  
2600 S Douglas Rd, Ste 1008,  
Coral Gables, FL 33134,  
United States of America
  - [74] LETTERS & THOO LIMITED  
Suite 1001-1003, 10/F, Prosperity Millennia Plaza,  
663 King's Road, Quarry Bay,  
Hong Kong



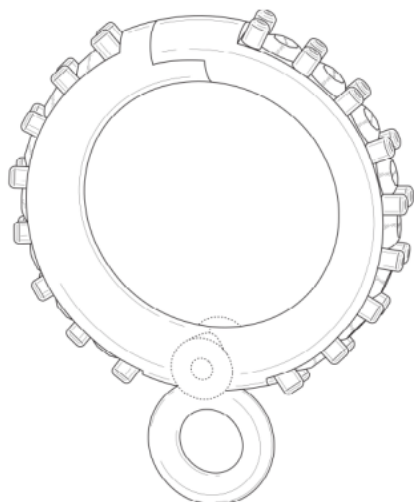

---

[11] 2423257.9M005

[15] 30-04-2024

[30] 31-10-2023 / US / US29/915,514

[51] Cl. 11-01

[54] 珠寶

Jewellery

[73] Raye Rocks LLC

2600 S Douglas Rd, Ste 1008,

Coral Gables, FL 33134,

United States of America

[74] LETTERS & THOO LIMITED

Suite 1001-1003, 10/F, Prosperity Millennia Plaza,

663 King's Road, Quarry Bay,

Hong Kong



- [11] 2423257.9M006
- [15] 30-04-2024
- [30] 31-10-2023 / US / US29/915,514
- [51] Cl. 11-01
- [54] 珠寶  
Jewellery
- [73] Raye Rocks LLC  
2600 S Douglas Rd, Ste 1008,  
Coral Gables, FL 33134,  
United States of America
- [74] LETTERS & THOO LIMITED  
Suite 1001-1003, 10/F, Prosperity Millennia Plaza,  
663 King's Road, Quarry Bay,  
Hong Kong



- 
- [11] 2423257.9M007
  - [15] 30-04-2024
  - [30] 31-10-2023 / US / US29/915,514
  - [51] Cl. 11-01
  - [54] 珠寶  
Jewellery
  - [73] Raye Rocks LLC  
2600 S Douglas Rd, Ste 1008,  
Coral Gables, FL 33134,  
United States of America
  - [74] LETTERS & THOO LIMITED  
Suite 1001-1003, 10/F, Prosperity Millennia Plaza,  
663 King's Road, Quarry Bay,  
Hong Kong



---

[11] 2423257.9M008

[15] 30-04-2024

[30] 31-10-2023 / US / US29/915,514

[51] Cl. 11-01

[54] 珠寶

Jewellery

[73] Raye Rocks LLC

2600 S Douglas Rd, Ste 1008,

Coral Gables, FL 33134,

United States of America

[74] LETTERS & THOO LIMITED

Suite 1001-1003, 10/F, Prosperity Millennia Plaza,

663 King's Road, Quarry Bay,

Hong Kong



[11] 2423257.9M009

[15] 30-04-2024

[30] 31-10-2023 / US / US29/915,514

[51] Cl. 11-01

[54] 珠寶

Jewellery

[73] Raye Rocks LLC

2600 S Douglas Rd, Ste 1008,

Coral Gables, FL 33134,

United States of America

[74] LETTERS & THOO LIMITED

Suite 1001-1003, 10/F, Prosperity Millennia Plaza,

663 King's Road, Quarry Bay,

Hong Kong

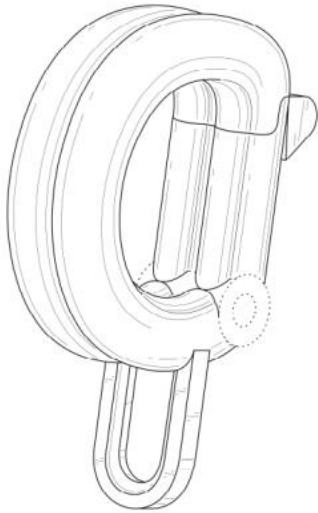

[11] 2423257.9M010

[15] 30-04-2024

[30] 31-10-2023 / US / US29/915,514

[51] Cl. 11-01

[54] 珠寶

Jewellery

[73] Raye Rocks LLC

2600 S Douglas Rd, Ste 1008,

Coral Gables, FL 33134,

United States of America

[74] LETTERS & THOO LIMITED

Suite 1001-1003, 10/F, Prosperity Millennia Plaza,

663 King's Road, Quarry Bay,

Hong Kong

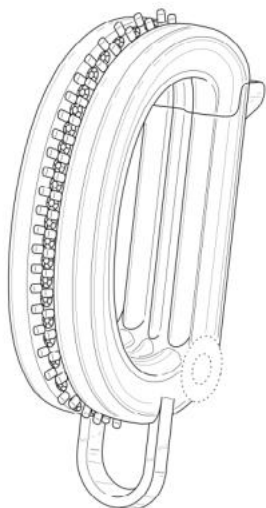

---

[11] 2423257.9M011

[15] 30-04-2024

[30] 31-10-2023 / US / US29/915,514

[51] Cl. 11-01

[54] 珠寶

Jewellery

[73] Raye Rocks LLC

2600 S Douglas Rd, Ste 1008,

Coral Gables, FL 33134,

United States of America

[74] LETTERS & THOO LIMITED

Suite 1001-1003, 10/F, Prosperity Millennia Plaza,

663 King's Road, Quarry Bay,

Hong Kong

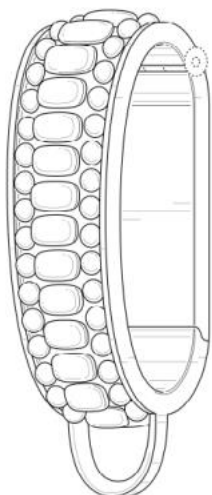

- [11] 2423338.1M001
- [15] 20-05-2024
- [30] 07-12-2023 / AM, AZ, BA, GE, LI, MK, MD, MC, ME, NO, OM, SG,  
CH, TN, TR, UA, GB, EU, AL / DM/233 777
- [51] Cl. 10-02
- [54] 手錶  
Wristwatch
- [73] ETA SA Manufacture Horlogere Suisse  
Schild-Rust-Strasse 17,  
2540 Grenchen,  
Switzerland
- [74] SPRUSON & FERGUSON (HONG KONG) LIMITED  
5001 Hopewell Centre,  
183 Queen's Road East, Wan Chai,  
Hong Kong



- 
- [11] 2423338.1M002
- [15] 20-05-2024
- [30] 07-12-2023 / AM, AZ, BA, GE, LI, MK, MD, MC, ME, NO, OM, SG,  
CH, TN, TR, UA, GB, EU, AL / DM/233 777
- [51] Cl. 10-02
- [54] 手錶  
Wristwatch
- [73] ETA SA Manufacture Horlogere Suisse  
Schild-Rust-Strasse 17,  
2540 Grenchen,  
Switzerland
- [74] SPRUSON & FERGUSON (HONG KONG) LIMITED  
5001 Hopewell Centre,

183 Queen's Road East, Wan Chai,  
Hong Kong



[11] 2423338.1M003

[15] 20-05-2024

[30] 07-12-2023 / AM, AZ, BA, GE, LI, MK, MD, MC, ME, NO, OM, SG,  
CH, TN, TR, UA, GB, EU, AL / DM/233 777

[51] Cl. 10-02

[54] 手錶

Wristwatch

[73] ETA SA Manufacture Horlogere Suisse  
Schild-Rust-Strasse 17,  
2540 Grenchen,  
Switzerland

[74] SPRUSON & FERGUSON (HONG KONG) LIMITED  
5001 Hopewell Centre,  
183 Queen's Road East, Wan Chai,  
Hong Kong



[11] 2423338.1M004

[15] 20-05-2024

[30] 07-12-2023 / AM, AZ, BA, GE, LI, MK, MD, MC, ME, NO, OM, SG,  
CH, TN, TR, UA, GB, EU, AL / DM/233 777

[51] Cl. 10-02

[54] 手錶

Wristwatch

[73] ETA SA Manufacture Horlogere Suisse  
Schild-Rust-Strasse 17,  
2540 Grenchen,  
Switzerland

[74] SPRUSON & FERGUSON (HONG KONG) LIMITED  
5001 Hopewell Centre,  
183 Queen's Road East, Wan Chai,  
Hong Kong





- [11] 2423338.1M005  
[15] 20-05-2024  
[30] 07-12-2023 / AM, AZ, BA, GE, LI, MK, MD, MC, ME, NO, OM, SG,  
CH, TN, TR, UA, GB, EU, AL / DM/233 777  
[51] Cl. 10-02  
[54] 手錶  
Wristwatch  
[73] ETA SA Manufacture Horlogere Suisse  
Schild-Rust-Strasse 17,  
2540 Grenchen,  
Switzerland  
[74] SPRUSON & FERGUSON (HONG KONG) LIMITED  
5001 Hopewell Centre,  
183 Queen's Road East, Wan Chai,  
Hong Kong



- [11] 2423375.9M001  
[15] 24-05-2024  
[51] Cl. 12-08  
[54] 汽車  
Automobile  
[73] Dr. Ing. h.c. F. Porsche Aktiengesellschaft  
Porscheplatz 1,  
70435 Stuttgart,  
Germany  
[74] WENPING PATENT & TRADE MARK AGENT LIMITED  
1701 Tung Wai Commercial Building,  
111 Gloucester Road,  
Hong Kong



---

[11] 2423375.9M002

[15] 24-05-2024

[51] Cl. 12-08

[54] 汽車

Automobile

[73] Dr. Ing. h.c. F. Porsche Aktiengesellschaft  
Porscheplatz 1,  
70435 Stuttgart,  
Germany

[74] WENPING PATENT & TRADE MARK AGENT LIMITED  
1701 Tung Wai Commercial Building,  
111 Gloucester Road,  
Hong Kong



---

[11] 2423375.9M003

[15] 24-05-2024

[51] Cl. 12-08

[54] 汽車

Automobile

[73] Dr. Ing. h.c. F. Porsche Aktiengesellschaft  
Porscheplatz 1,  
70435 Stuttgart,  
Germany

[74] WENPING PATENT & TRADE MARK AGENT LIMITED  
1701 Tung Wai Commercial Building,  
111 Gloucester Road,  
Hong Kong



---

[11] 2423376.1M001

[15] 24-05-2024

[51] Cl. 21-01

[54] 模型車

Model car

[73] Dr. Ing. h.c. F. Porsche Aktiengesellschaft  
Porscheplatz 1,  
70435 Stuttgart,  
Germany

[74] WENPING PATENT & TRADE MARK AGENT LIMITED  
1701 Tung Wai Commercial Building,  
111 Gloucester Road,  
Hong Kong



---

[11] 2423376.1M002

[15] 24-05-2024

[51] Cl. 21-01

[54] 模型車

Model car

[73] Dr. Ing. h.c. F. Porsche Aktiengesellschaft  
Porscheplatz 1,  
70435 Stuttgart,  
Germany

[74] WENPING PATENT & TRADE MARK AGENT LIMITED  
1701 Tung Wai Commercial Building,

111 Gloucester Road,  
Hong Kong



---

[11] 2423376.1M003

[15] 24-05-2024

[51] Cl. 21-01

[54] 模型車

Model car

[73] Dr. Ing. h.c. F. Porsche Aktiengesellschaft  
Porscheplatz 1,  
70435 Stuttgart,  
Germany

[74] WENPING PATENT & TRADE MARK AGENT LIMITED  
1701 Tung Wai Commercial Building,  
111 Gloucester Road,  
Hong Kong



---

[11] 2423538.6

[15] 18-06-2024

[51] Cl. 2-04

[54] 鞋底

Sole for footwear

[73] Airwair International Limited  
Cobb's Lane, Wollaston, Wellingborough,  
Northamptonshire NN29 7SW,  
United Kingdom

- [74] HOGAN LOVELLS  
11th Floor, One Pacific Place,  
88 Queensway,  
Hong Kong



- [11] 2423540.0  
[15] 18-06-2024  
[30] 08-01-2024 / CA, AM, AZ, BA, GE, LI, MK, MD, MX, MC, ME, NO,  
OM, RU, SG, CH, TN, TR, UA, GB, EU, AL, IL, JP, KR / DM/237326  
[51] Cl. 20-02  
[54] 手錶陳列架  
Display stand for watches  
[73] ETA SA Manufacture Horlogere Suisse  
Schild-Rust-Strasse 17,  
2540 Grenchen,  
Switzerland  
[74] SPRUSON & FERGUSON (HONG KONG) LIMITED  
5001 Hopewell Centre,  
183 Queen's Road East, Wan Chai,  
Hong Kong

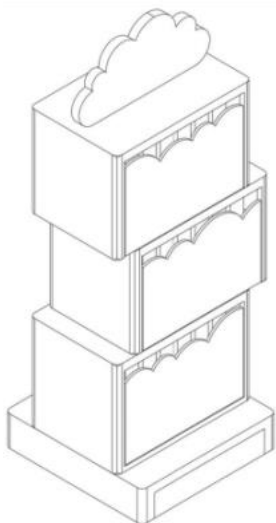

- [11] 2423545.1M001
- [15] 19-06-2024
- [30] 22-12-2023 / CH, GB, EU / WIPO142200
- [51] Cl. 10-07
- [54] 錶殼  
Watch case
- [73] RICHEMONT INTERNATIONAL SA  
Route des biches 10,  
1752 VILLARS-SUR-GLANE,  
SWITZERLAND
- [74] LETTERS & THOO LIMITED  
Suite 1001-1003, 10/F, Prosperity Millennia Plaza,  
663 King's Road, Quarry Bay,  
Hong Kong

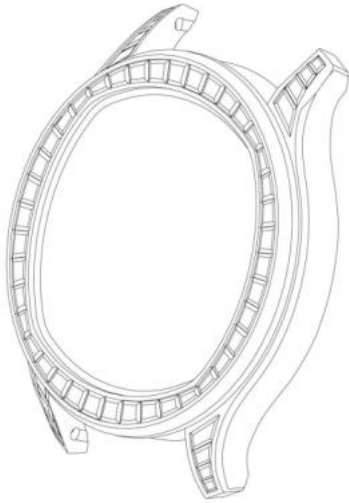

- 
- [11] 2423545.1M002
  - [15] 19-06-2024
  - [30] 22-12-2023 / CH, GB, EU / WIPO142200
  - [51] Cl. 10-07
  - [54] 錶盤  
Watch dial
  - [73] RICHEMONT INTERNATIONAL SA  
Route des biches 10,  
1752 VILLARS-SUR-GLANE,  
SWITZERLAND
  - [74] LETTERS & THOO LIMITED  
Suite 1001-1003, 10/F, Prosperity Millennia Plaza,  
663 King's Road, Quarry Bay,  
Hong Kong

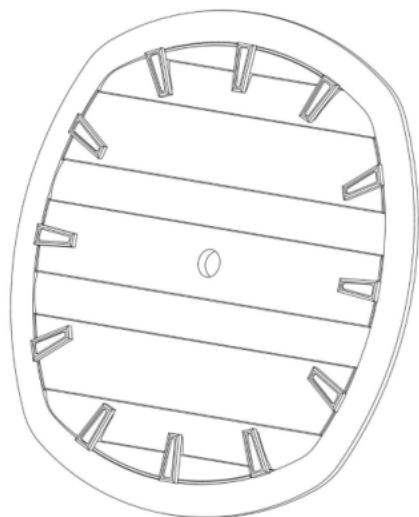

---

[11] 2423545.1M003

[15] 19-06-2024

[30] 22-12-2023 / CH, GB, EU / WIPO142200

[51] Cl. 10-02

[54] 錶

Watch

[73] RICHEMONT INTERNATIONAL SA

Route des biches 10,  
1752 VILLARS-SUR-GLANE,  
SWITZERLAND

[74] LETTERS & THOO LIMITED

Suite 1001-1003, 10/F, Prosperity Millennia Plaza,  
663 King's Road, Quarry Bay,  
Hong Kong

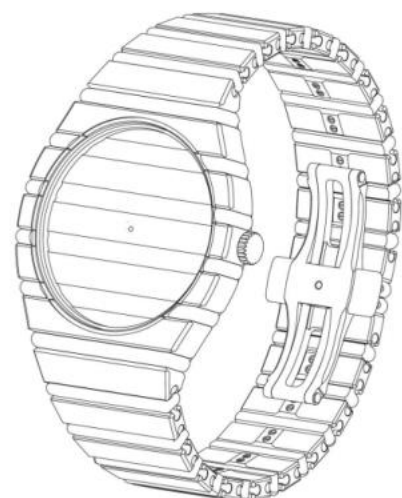

- [11] 2423545.1M004  
[15] 19-06-2024  
[30] 22-12-2023 / CH, GB, EU / WIPO142200  
[51] Cl. 10-02  
[54] 錶  
Watch  
[73] RICHEMONT INTERNATIONAL SA  
Route des biches 10,  
1752 VILLARS-SUR-GLANE,  
SWITZERLAND  
[74] LETTERS & THOO LIMITED  
Suite 1001-1003, 10/F, Prosperity Millennia Plaza,  
663 King's Road, Quarry Bay,  
Hong Kong

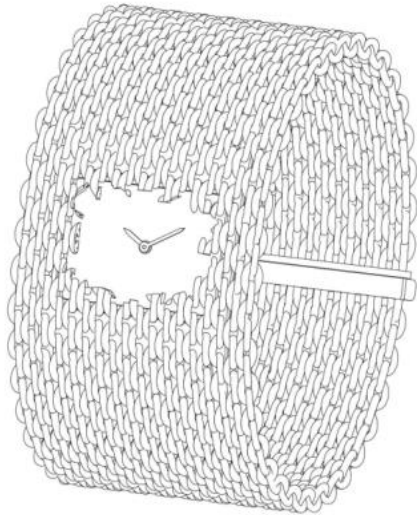

- 
- [11] 2423545.1M005  
[15] 19-06-2024  
[30] 22-12-2023 / CH, GB, EU / WIPO142200  
[51] Cl. 10-07  
[54] 錶殼和錶盤  
Watch case and dial  
[73] RICHEMONT INTERNATIONAL SA  
Route des biches 10,  
1752 VILLARS-SUR-GLANE,  
SWITZERLAND  
[74] LETTERS & THOO LIMITED  
Suite 1001-1003, 10/F, Prosperity Millennia Plaza,  
663 King's Road, Quarry Bay,  
Hong Kong





---

[11] 2423545.1M006

[15] 19-06-2024

[30] 22-12-2023 / CH, GB, EU / WIPO142200

[51] Cl. 10-07

[54] 錶盤

Watch dial

[73] RICHEMONT INTERNATIONAL SA

Route des biches 10,  
1752 VILLARS-SUR-GLANE,  
SWITZERLAND

[74] LETTERS & THOO LIMITED

Suite 1001-1003, 10/F, Prosperity Millennia Plaza,  
663 King's Road, Quarry Bay,  
Hong Kong

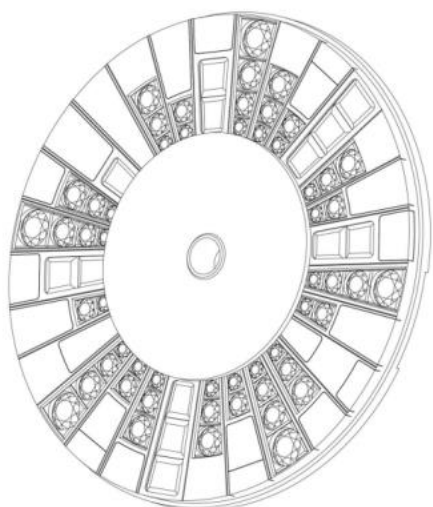

- [11] 2423545.1M007  
[15] 19-06-2024  
[30] 22-12-2023 / CH, GB, EU / WIPO142200  
[51] Cl. 10-02  
[54] 錶  
Watch  
[73] RICHEMONT INTERNATIONAL SA  
Route des biches 10,  
1752 VILLARS-SUR-GLANE,  
SWITZERLAND  
[74] LETTERS & THOO LIMITED  
Suite 1001-1003, 10/F, Prosperity Millennia Plaza,  
663 King's Road, Quarry Bay,  
Hong Kong



- 
- [11] 2423545.1M008  
[15] 19-06-2024  
[30] 22-12-2023 / CH, GB, EU / WIPO142200  
[51] Cl. 10-07  
[54] 錶盤  
Watch dial  
[73] RICHEMONT INTERNATIONAL SA  
Route des biches 10,  
1752 VILLARS-SUR-GLANE,  
SWITZERLAND  
[74] LETTERS & THOO LIMITED  
Suite 1001-1003, 10/F, Prosperity Millennia Plaza,  
663 King's Road, Quarry Bay,  
Hong Kong

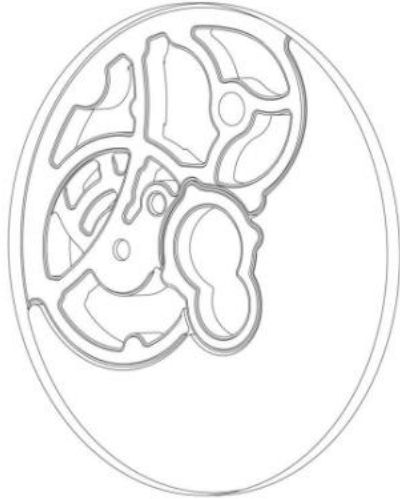

---

[11] 2423554.9M001

[15] 20-06-2024

[51] Cl. 19-08

[54] 包裝標籤

Packaging label

[73] 亞倫亞當有限公司

Aaron Adam Limited

Unit A, 15/F, Block 1, Leader Industrial Centre,  
188-202 Texaco Road, Tsuen Wan,  
Hong Kong

[74] Aaron Adam Limited

Unit A, 15/F, Block 1, Leader Industrial Centre,  
188-202 Texaco Road, Tsuen Wan,  
Hong Kong



---

[11] 2423554.9M002

[15] 20-06-2024

[51] Cl. 19-08

[54] 包裝標籤

Packaging label

[73] 亞倫亞當有限公司

Aaron Adam Limited

Unit A, 15/F, Block 1, Leader Industrial Centre,  
188-202 Texaco Road, Tsuen Wan,  
Hong Kong

[74] Aaron Adam Limited  
Unit A, 15/F, Block 1, Leader Industrial Centre,  
188-202 Texaco Road, Tsuen Wan,  
Hong Kong



[11] 2423554.9M003

[15] 20-06-2024

[51] Cl. 19-08

[54] 包裝標籤  
Packaging label

[73] 亞倫亞當有限公司  
Aaron Adam Limited  
Unit A, 15/F, Block 1, Leader Industrial Centre,  
188-202 Texaco Road, Tsuen Wan,  
Hong Kong

[74] Aaron Adam Limited  
Unit A, 15/F, Block 1, Leader Industrial Centre,  
188-202 Texaco Road, Tsuen Wan,  
Hong Kong



[11] 2423554.9M004

[15] 20-06-2024

[51] Cl. 19-08

[54] 包裝標籤  
Packaging label

[73] 亞倫亞當有限公司  
Aaron Adam Limited  
Unit A, 15/F, Block 1, Leader Industrial Centre,

188-202 Texaco Road, Tsuen Wan,  
Hong Kong

[74] Aaron Adam Limited  
Unit A, 15/F, Block 1, Leader Industrial Centre,  
188-202 Texaco Road, Tsuen Wan,  
Hong Kong



[11] 2423554.9M005

[15] 20-06-2024

[51] Cl. 19-08

[54] 包裝標籤  
Packaging label

[73] 亞倫亞當有限公司  
Aaron Adam Limited  
Unit A, 15/F, Block 1, Leader Industrial Centre,  
188-202 Texaco Road, Tsuen Wan,  
Hong Kong

[74] Aaron Adam Limited  
Unit A, 15/F, Block 1, Leader Industrial Centre,  
188-202 Texaco Road, Tsuen Wan,  
Hong Kong



[11] 2423554.9M006

[15] 20-06-2024

[51] Cl. 19-08

[54] 包裝標籤  
Packaging label

[73] 亞倫亞當有限公司  
Aaron Adam Limited  
Unit A, 15/F, Block 1, Leader Industrial Centre,  
188-202 Texaco Road, Tsuen Wan,  
Hong Kong

[74] Aaron Adam Limited  
 Unit A, 15/F, Block 1, Leader Industrial Centre,  
 188-202 Texaco Road, Tsuen Wan,  
 Hong Kong



[11] 2423554.9M007

[15] 20-06-2024

[51] Cl. 19-08

[54] 包裝標籤  
 Packaging label

[73] 亞倫亞當有限公司  
 Aaron Adam Limited  
 Unit A, 15/F, Block 1, Leader Industrial Centre,  
 188-202 Texaco Road, Tsuen Wan,  
 Hong Kong

[74] Aaron Adam Limited  
 Unit A, 15/F, Block 1, Leader Industrial Centre,  
 188-202 Texaco Road, Tsuen Wan,  
 Hong Kong



[11] 2423559.0

[15] 21-06-2024

[51] Cl. 9-03

[54] 牙膏包裝盒  
 Packaging carton for tooth paste

[73] 林松枝  
 LAM CHUNG CHI  
 Block A, 21st Floor, Sun Ying Industrial Centre,  
 9 Tin Wan Close,  
 Hong Kong

林松雄

LIN SONG XIONG

Block A, 21st Floor, Sun Ying Industrial Centre,  
9 Tin Wan Close,  
Hong Kong

[74] VINCENT LUK & ASSOCIATES

Unit A, 13th Floor, Nathan Commercial Building,  
430 Nathan Road, Kowloon,  
Hong Kong



[11] 2423562.6

[15] 21-06-2024

[30] 19-01-2024 / CA, AM, AZ, BZ, BA, GE, LI, MK, MD, MC, MN, ME,  
MA, NO, OM, RU, SG, CH, TN, TR, UA, GB, EU, AL, KG / DM/235890

[51] Cl. 10-07

[54] 錶面  
Dial

[73] OMEGA SA (OMEGA AG) (OMEGA LTD.)  
Jakob-Stämpfli-Strasse 96,  
CH-2502 Biel/Bienne,  
Switzerland

[74] SPRUSON & FERGUSON (HONG KONG) LIMITED  
5001 Hopewell Centre,  
183 Queen's Road East, Wan Chai,  
Hong Kong

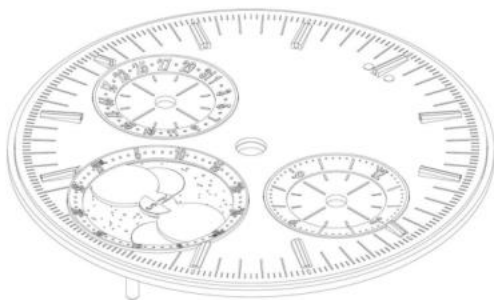

[11] 2423563.8

[15] 21-06-2024

[51] Cl. 30-99

[54] 寵物烘乾機  
Pet dryer

[73] 鄧一康  
Yikang DENG  
中國  
廣東省深圳市龍崗區寶龍三路 2 號 (郵編: 518116)

[74] 中港專利有限公司  
香港  
灣仔告士打道 151 號資本中心 15 樓 1502 室

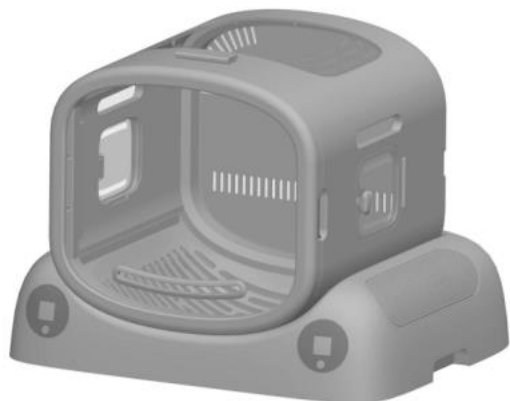

---

[11] 2423564.0

[15] 21-06-2024

[51] Cl. 13-02

[54] 啟動電源  
Starting power supply

[73] 銀戰士有限公司  
VINNIC POWER CO., LIMITED  
香港  
龍油塘草園街 4 號  
華順工業大廈二樓 B 室

[74] 弘研知識產權有限公司  
香港  
荃灣海盛路 3 號  
TML 大廈 16 樓 A5 室



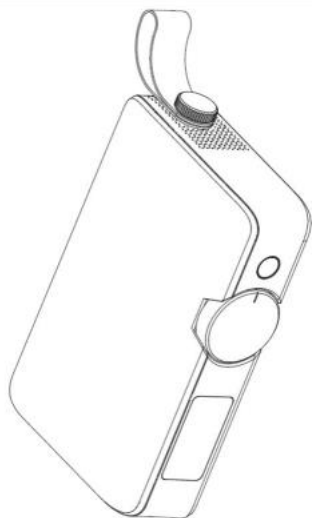

[11] 2423567.7

[15] 21-06-2024

[30] 25-12-2023 / CN / 2023308488579

[51] C1. 9-03

[54] 收納盒

Storage box

[73] 汕头市兰斯佰蒂服饰有限公司

Shantou Lansibaidi Clothing Co., Ltd.

中國

广东省汕头市金平区

跃进路 23 号 1 幢 1204 号房之一 515000

[74] 百睿知識產權有限公司

香港

新界沙田香港科學園

科技大道西 10 號浚湖樓 617 室

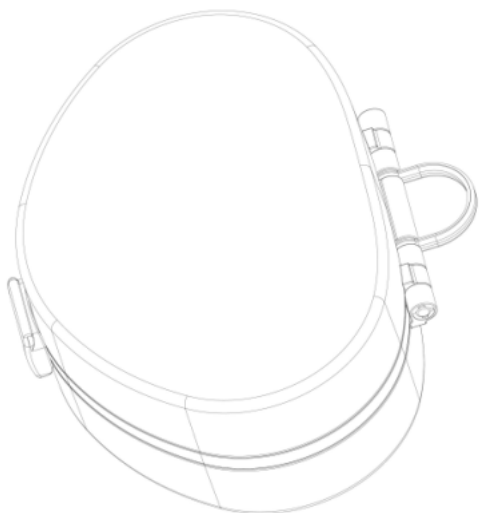

[11] 2423578.0

[15] 24-06-2024

[51] Cl. 19-01

[54] 練字格紙  
Writing paper

[73] 郭立新  
Lixin Guo  
中國  
江西省贛州市寧都縣對坊鄉王坑村下王坑組

[74] 卓遠知識產權有限公司  
香港  
上環禧利街 27 號  
富輝商業中心 10 樓

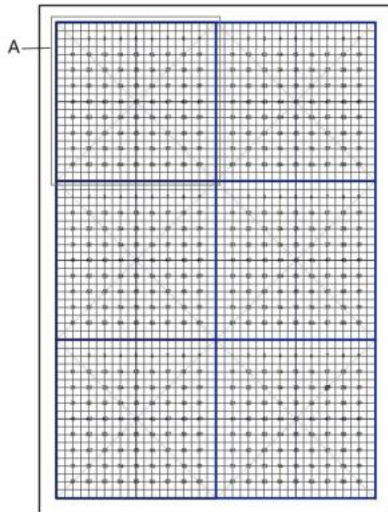

---

[11] 2423579.2M001

[15] 24-06-2024

[30] 25-12-2023 / JP / 2023-026786

[51] Cl. 22-06

[54] 防蟲器具  
Insect repellent member

[73] 大日本除虫菊株式会社  
DAINIHON JOCHUGIKU CO., LTD.  
4-11, Tosabori 1-chome, Nishi-ku, Osaka-shi,  
Osaka 5500001,  
Japan

[74] UNITALEN ATTORNEYS AT LAW LIMITED  
Unit No.1211, Level 12, Tower I,

Grand Century Place,  
193 Prince Edward Road West, Mongkok,  
Kowloon, Hong Kong

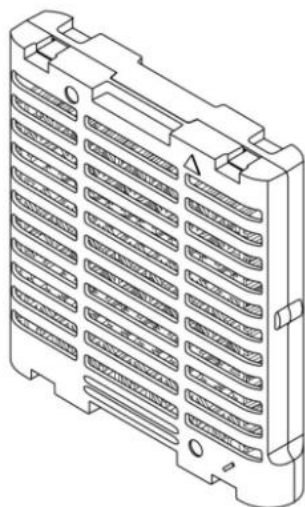

---

[11] 2423579.2M002

[15] 24-06-2024

[30] 25-12-2023 / JP / 2023-026787

[51] C1. 22-06

[54] 防蟲器具

Insect repellent member

[73] 大日本除虫菊株式会社

DAINIHON JOCHUGIKU CO., LTD.

4-11, Tosabori 1-chome, Nishi-ku, Osaka-shi,

Osaka 5500001,

Japan

[74] UNITALEN ATTORNEYS AT LAW LIMITED

Unit No.1211, Level 12, Tower I,

Grand Century Place,

193 Prince Edward Road West, Mongkok,

Kowloon, Hong Kong

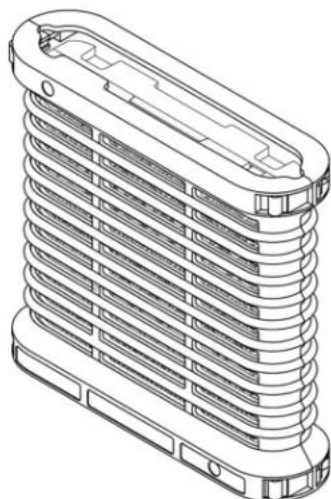

---

[11] 2423580.4

[15] 24-06-2024

[30] 25-12-2023 / JP / 2023-026785

[51] Cl. 22-06

[54] 防蟲器具

Insect repellent member

[73] 大日本除虫菊株式会社

DAINIHON JOCHUGIKU CO., LTD.

4-11, Tosabori 1-chome, Nishi-ku, Osaka-shi,

Osaka 5500001,

Japan

共栄产业株式会社

KYOEI SANGYO CO., LTD.

45-1, Ikuno 6-chome, Katano-shi,

Osaka 5760054,

Japan

[74] UNITALEN ATTORNEYS AT LAW LIMITED

Unit No.1211, Level 12, Tower I,

Grand Century Place,

193 Prince Edward Road West, Mongkok,

Kowloon, Hong Kong

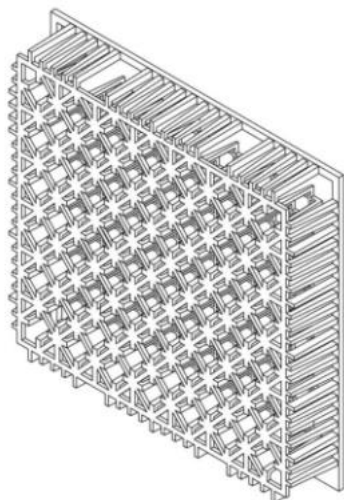



香港特別行政區政府知識產權署外觀設計註冊處

The Government of the Hong Kong Special Administrative Region

Designs Registry, Intellectual Property Department

根據註冊外觀設計條例第 28 條，下列註冊外觀設計因未繳續期費而停止有效。

各組記項按註冊外觀設計停止有效日期及註冊編號先後次序排列。

**Registered designs ceased through non-payment of renewal fees under section 28 of the Registered Designs Ordinance. Entries are listed below under their expiry dates.**

**27-06-2024 - 03-07-2024**

<b>27-06-2024</b>	1914102.3	1401252.0
1914092.0	1914103.5M001	1401253.2M001
1914093.2	1914103.5M002	1401253.2M002
1914100.9M001	1914104.7	1914127.6
1914100.9M002	1914107.4	1914128.8
1914100.9M003	1914108.6	
1914100.9M004		

**02-07-2024**

<b>28-06-2024</b>	0901048.1M001
0901028.9M001	0901048.1M002
0901028.9M005	0901048.1M003
	0901048.1M004

<b>29-06-2024</b>	1401238.1M001
0901040.4	1401238.1M002
1401221.5	1401238.1M003
1401225.4	1401244.3
	1914114.8

<b>01-07-2024</b>	1914115.1
0411445.0	1914116.3M001
0901041.6M001	1914116.3M002
0901041.6M002	1914116.3M003
0901041.6M003	1914117.5
0901042.8	1914119.9
0901044.2	1914122.5M001
1401228.0M001	1914122.5M002
1401228.0M002	
1401228.0M003	

**03-07-2024**

	1401249.4M002
	1401249.4M003
	1401251.8M001
	1401251.8M002
	1401251.8M003
	1401251.8M004
	1401251.8M005



香港特別行政區政府知識產權署外觀設計註冊處

The Government of the Hong Kong Special Administrative Region

Designs Registry, Intellectual Property Department

根據註冊外觀設計規則第 31 條刪除的註冊外觀設計。各組記項按註冊外觀設計刪除日期及註冊編號先後次序排列。

**Registered designs removed under section 31 of the Registered Designs Rules. Entries are listed below under their removal dates.**

**05-07-2024 - 11-07-2024**

<b>05-07-2024</b>	1302325.6M007	<b>10-07-2024</b>
1802556.1	1302326.8M001	1400014.5
1802557.3	1302326.8M003	1400016.0
1802558.5	1302326.8M009	1900021.5
1802559.7	1302327.0M001	1900022.7
1802563.5	1302327.0M003	1900024.1
1802565.0M001	1302327.0M007	
1802565.0M002	1302327.0M009	<b>11-07-2024</b>
1802565.0M003	1302328.2M001	1900025.4
1802566.2	1302328.2M002	1900026.6M001
1802567.4	1302328.2M003	1900026.6M002
1802568.6	1302328.2M004	1900026.6M003
1802569.8	1302328.2M005	1900026.6M004
1802571.2M001	1302328.2M006	1900026.6M005
1802572.4M001	1302328.2M007	1900027.8
	1302328.2M008	1900028.0M001
<b>06-07-2024</b>	1302328.2M009	1900028.0M002
0312271.0	1302328.2M010	1900028.0M003
1802573.6M001		1900028.0M004
1802573.6M002	<b>08-07-2024</b>	1900029.2M001
1802573.6M003	1802583.7	1900029.2M002
1802573.6M004		1900029.2M003
1802574.8	<b>09-07-2024</b>	1900029.2M004
1802576.3M001	1400005.7	1900029.2M005
1802577.5	1900002.5M001	1900029.2M006
1802578.7	1900005.2M001	1900029.2M007
	1900005.2M002	1900029.2M008
<b>07-07-2024</b>	1900005.2M003	
0803068.4	1900008.8M002	
0803069.6	1900008.8M003	
0803073.4	1900008.8M005	
1302325.6M001	1900013.8	
1302325.6M003	1900014.0	
1302325.6M005		



香港特別行政區政府知識產權署外觀設計註冊處

The Government of the Hong Kong Special Administrative Region

Designs Registry, Intellectual Property Department

## 根據註冊外觀設計條例第 76 條，更正已提交文件中的錯誤

### Correction of errors in filed documents under section 76 of the Registered Designs Ordinance

任何人士現可對下列更正錯誤的請求提出反對

Request for correction of errors now open to opposition

如任何人士意欲反對下列請求，則須在本官方公報刊登是項更正請求的日期起計的兩個月內，根據註冊外觀設計規則第 62(4) 條，採用指明外觀設計表格第 D9 號提交反對通知。如在限期內沒有收到任何反對通知，處長將依本公報刊登的更正請求的內容，准許是項更正請求。

If any person wishes to oppose the following request, he shall file a notice of opposition in specified Designs Form D9 within two months from the date of advertisement in this official journal under section 62(4) of the Registered Designs Rules. If no notice of opposition is received, the request for correction will be allowed by the Registrar in the present advertised form.

請求更正表述的錯誤

Request made for correction of errors in representations

[21] 2423196.9M007

[55] 外觀設計的表述

Representations of the Design