

香港知識產權公報

Hong Kong Intellectual Property Journal

2024年5月31日

31 May 2024



目錄 Contents

根據註冊外觀設計條例第 25 條註冊的外觀設計

Designs Registered under section 25 of the Registered Designs Ordinance

按註冊編號排列

Arranged by Registration Number

根據註冊外觀設計條例(第 522 章)公布的其他公告

Other Notices Published under the Registered Designs Ordinance (Cap. 522)

根據註冊外觀設計條例第 28 條，註冊外觀設計因未繳續期費而停止有效

Registered designs ceased through non-payment of renewal fees under section 28 of the Registered Designs Ordinance

根據註冊外觀設計規則第 31 條刪除的註冊外觀設計

Registered designs removed under section 31 of the Registered Designs Rules

根據註冊外觀設計條例第 76 條，更正已提交文件中的錯誤

Correction of errors in filed documents under section 76 of the Registered Designs Ordinance

以下事項沒有記錄

No Records for the Following Matters

根據註冊外觀設計條例第 30 條放棄的外觀設計的註冊

Surrender of Registration of Design under section 30 of the Registered Designs Ordinance

根據註冊外觀設計規則第 37 條，向處長作出轉介

Reference to Registrar under section 37 of the Registered Designs Rules

根據註冊外觀設計條例第 45 條，撤銷註冊

Revocation of Registration under section 45 of the Registered Designs Ordinance

根據註冊外觀設計規則第 46 條，向法院作出轉介

Reference to Court under section 46 of the Registered Designs Rules

根據註冊外觀設計規則第 63 條對不符合規定之處作出糾正

Rectification of Irregularities under section 63 of the Registered Designs Rules

根據註冊外觀設計條例第 66 條，糾正註冊紀錄冊

Rectification of Register under section 66 of the Registered Designs Ordinance

根據註冊外觀設計條例第 67 條 更正註冊紀錄冊內的錯誤

Correction of errors in Register under section 67 of the Registered Designs Ordinance

根據註冊外觀設計條例第 67 及 76 條，更正註冊紀錄冊內及已提交文件中的錯誤

Correction of Errors in Register and in Filed Documents under sections 67 and 76 of the Registered Designs Ordinance

勘誤

Corrigendum

註冊外觀設計公告註釋

Notes on advertisements of registration of designs

方括號表示下列資料：

Square brackets indicate the following data：

[11] 註冊編號 Registration number / 聯合王國註冊編號 United Kingdom registration number

[15] 註冊日期 Registration date / 當作註冊日期 Deemed registration date / 聯合王國註冊日期 United Kingdom registration date

[17] 註冊有效期屆滿日期 Expiry date of the period of registration

[22] 提交日期 Filing date / 當作提交日期 Deemed filing date / 聯合王國提交日期 United Kingdom filing date

[30] 聲稱享有的優先權（提交日期 / 巴黎公約國或世界貿易組織成員 / 申請編號） Priority claimed (filing date / Paris Convention country or WTO member / application number)

[51] 國際外觀設計分類號（洛迦諾分類號） International Classification of designs (Locarno Classification)

[54] 物品 Article

[55] 外觀設計的表述 Representation of the design

[62] 分開前的申請編號及提交日期 Application number before division and filing date

[66] 過往註冊的聯繫外觀設計註冊編號 / 日期 Registration No. / Date of Previous Registration for Association

[72] 設計人 Designer

[73] 擁有人姓名和地址 Name and address of the owner

[74] 代理人 Agent / 送達地址 Address for service



香港特別行政區政府知識產權署外觀設計註冊處

The Government of the Hong Kong Special Administrative Region

Designs Registry, Intellectual Property Department

根據註冊外觀設計條例第 25 條註冊的外觀設計

Designs registered under section 25 of the Registered Designs Ordinance

按註冊編號排列

Arranged by Registration Number

[11] 2422661.5

[15] 11-01-2024

[30] 13-07-2023 / DE / 40 2023 100 481.0

[51] Cl. 21-01

[54] 玩具車

Toy vehicle

[73] VOLKSWAGEN AKTIENGESELLSCHAFT

Berliner Ring 2,

38440 Wolfsburg,

Germany

[74] CHINA PATENT AGENT (HONG KONG) LIMITED

22/F, Great Eagle Centre,

23 Harbour Road,

Wanchai, Hong Kong



[11] 2422677.9M001

[15] 12-01-2024

[30] 13-07-2023 / US / 29/879,833

[51] Cl. 9-03

[54] 盒

Box

[73] ELI LILLY AND COMPANY

P.O. Box 6288,

Indianapolis, IN 46206-6288,
United States of America

[74] MARKS & CLERK
Level 9, Cyberport 1,
100 Cyberport Road,
Pok Fu Lam, Hong Kong



[11] 2422677.9M002

[15] 12-01-2024

[30] 13-07-2023 / US / 29/879,833

[51] Cl. 9-03

[54] 盒
Box

[73] ELI LILLY AND COMPANY
P.O. Box 6288,
Indianapolis, IN 46206-6288,
United States of America

[74] MARKS & CLERK
Level 9, Cyberport 1,
100 Cyberport Road,
Pok Fu Lam, Hong Kong



[11] 2422677.9M003

[15] 12-01-2024

[30] 13-07-2023 / US / 29/879,833

[51] Cl. 9-03

[54] 盒

Box

[73] ELI LILLY AND COMPANY

P.O. Box 6288,

Indianapolis, IN 46206-6288,

United States of America

[74] MARKS & CLERK

Level 9, Cyberport 1,

100 Cyberport Road,

Pok Fu Lam, Hong Kong

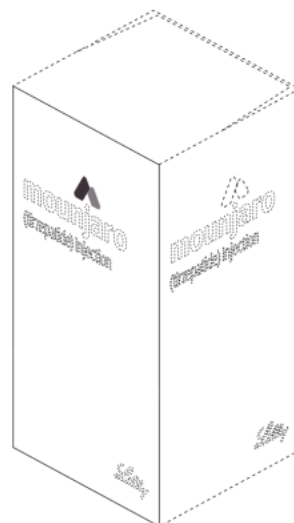

- [11] 2422677.9M004
[15] 12-01-2024
[30] 13-07-2023 / US / 29/879,833
[51] Cl. 9-03
[54] 盒
Box
[73] ELI LILLY AND COMPANY
P.O. Box 6288,
Indianapolis, IN 46206-6288,
United States of America
[74] MARKS & CLERK
Level 9, Cyberport 1,
100 Cyberport Road,
Pok Fu Lam, Hong Kong



-
- [11] 2422694.4
[15] 17-01-2024
[30] 10-11-2023 / TW / 112305804
[51] Cl. 26-02
[54] 手燈
Hand lamp
[73] 相信音樂國際股份有限公司
B'IN MUSIC INTERNATIONAL LIMITED
2F., 6F., 7F., No. 12, Ln. 33, Guangfu S. Rd.,
Songshan Dist., Taipei City 10563,
Taiwan
[74] MARKS & CLERK
Level 9, Cyberport 1,
100 Cyberport Road,
Pok Fu Lam, Hong Kong

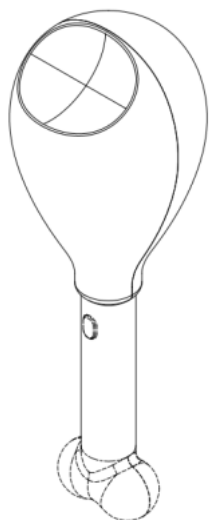

[11] 2422728.8

[15] 24-01-2024

[51] Cl. 16-01

[54] 相機專用外殼
Camera housing

[73] 美景圖有限公司
SEENICPRO CO. LIMITED
Flat B, 22/F, Island Garden Tower 2,
33 Chai Wan Road,
Shau Kei Wan, Hong Kong

[74] WENPING PATENT & TRADE MARK AGENT LIMITED
1701 Tung Wai Commercial Building,
111 Gloucester Road,
Hong Kong

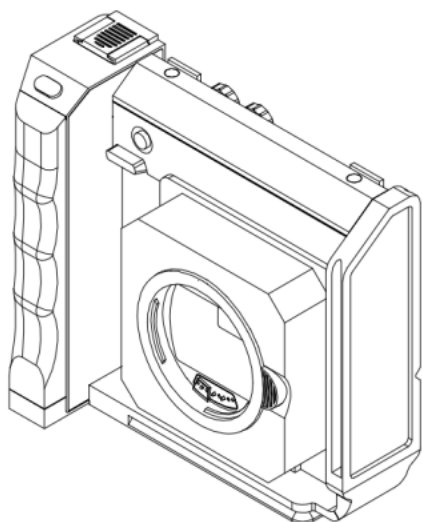

- [11] 2422787.2M001
[15] 04-02-2024
[30] 05-01-2024 / CN / 2024300060647
[51] C1. 11-01
[54] 珠寶飾品
Jewellery ornament
[73] 周大福珠寶金行(深圳)有限公司
CHOW TAI FOOK JEWELLERY (SHENZHEN) CO., LTD.
中國廣東省
深圳市鹽田區深鹽路
黃金珠寶大廈 12 樓 A 座
[74] 中一聯合國際知識產權有限公司
香港九龍觀塘
興業街 20 號
聯合興業工業大廈 5 樓 A26 室



-
- [11] 2422787.2M002
[15] 04-02-2024
[30] 05-01-2024 / CN / 2024300060365
[51] C1. 11-01
[54] 珠寶飾品
Jewellery ornament
[73] 周大福珠寶金行(深圳)有限公司
CHOW TAI FOOK JEWELLERY (SHENZHEN) CO., LTD.
中國廣東省
深圳市鹽田區深鹽路
黃金珠寶大廈 12 樓 A 座

- [74] 中一聯合國際知識產權有限公司
香港九龍觀塘
興業街 20 號
聯合興業工業大廈 5 樓 A26 室



-
- [11] 2422918.1
[15] 08-03-2024
[51] Cl. 21-02
[54] 折疊運動架
Folding exercise stand frame
[73] TRINH NGUYEN KHANH LE
Room 912, Building B4, Greenstars Apt building,
234 Pham Van Dong st, Co Nhue 1,
Bac Tu Liem Dist, Ha Noi - 100000, Vietnam,
Viet Nam
[74] PATENT AND DESIGN LIMITED
Room A20, Floor 2A1, Paksang Industrial Building,
16 San On Street,
Tuen Mun, Hong Kong

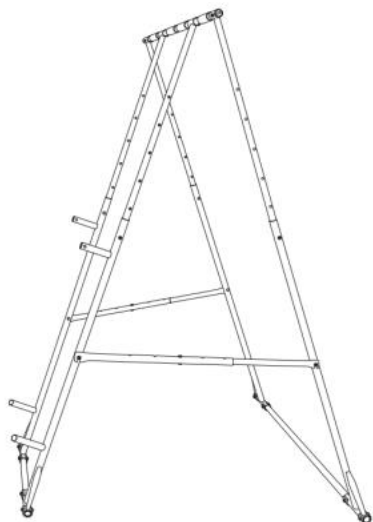

[11] 2422920.5

[15] 08-03-2024

[51] Cl. 11-01

[54] 項鍊

Necklace

[73] 何明詩

HO MING SZE EUGENIE

3/F,

No. 17 Ho Man Tin Street,

Kowloon, Hong Kong

[74] 何明詩

3/F,

No. 17 Ho Man Tin St,

Kowloon, Hong Kong



[11] 2422926.8M001

[15] 11-03-2024

[51] Cl. 2-05

[54] 暖脖圈

Neck warmer

[73] 廣州希希貝拉信息科技有限公司

Guangzhou Xixi Bella Information Technology Co., Ltd.

中國

廣東省廣州市天河區

翰景路1號1901房自編ABCD1H1部位A2-51

[74] LISHI INTELLECTUAL PROPERTY GROUP (INTERNATIONAL) LIMITED

香港九龍觀塘

興業街15-17號

中美中心B座9樓9045室



[11] 2422926.8M002

[15] 11-03-2024

[51] Cl. 2-05

[54] 暖脖圈

Neck warmer

[73] 廣州希希貝拉信息科技有限公司

Guangzhou Xixi Bella Information Technology Co., Ltd.

中國

廣東省廣州市天河區

翰景路1號1901房自編ABCD1H1部位A2-51

[74] LISHI INTELLECTUAL PROPERTY GROUP (INTERNATIONAL) LIMITED

香港九龍觀塘

興業街15-17號

中美中心B座9樓9045室



[11] 2422932.0M001

[15] 11-03-2024

[30] 15-11-2023 / EU / 015041140-0001

[51] Cl. 6-01

[54] 汽車座椅

Vehicle seats

[73] Dr. Ing. h.c. F. Porsche Aktiengesellschaft

Porscheplatz 1,
70435 Stuttgart,
Germany

[74] WENPING PATENT & TRADE MARK AGENT LIMITED

1701 Tung Wai Commercial Building,
111 Gloucester Road,
Hong Kong



[11] 2422932.0M002

[15] 11-03-2024

[30] 15-11-2023 / EU / 015041140-0002

[51] Cl. 6-01

[54] 汽車座椅

Vehicle seats

[73] Dr. Ing. h.c. F. Porsche Aktiengesellschaft

Porscheplatz 1,
70435 Stuttgart,
Germany

[74] WENPING PATENT & TRADE MARK AGENT LIMITED

1701 Tung Wai Commercial Building,
111 Gloucester Road,
Hong Kong



[11] 2422932.0M003

[15] 11-03-2024

[30] 15-11-2023 / EU / 015041140-0003

[51] Cl. 6-01

[54] 汽車座椅

Vehicle seat

[73] Dr. Ing. h.c. F. Porsche Aktiengesellschaft

Porscheplatz 1,
70435 Stuttgart,
Germany

[74] WENPING PATENT & TRADE MARK AGENT LIMITED

1701 Tung Wai Commercial Building,
111 Gloucester Road,
Hong Kong



[11] 2422932.0M004

[15] 11-03-2024

[30] 15-11-2023 / EU / 015041140-0004

[51] Cl. 6-01

[54] 汽車座椅

Vehicle seat

[73] Dr. Ing. h.c. F. Porsche Aktiengesellschaft

Porscheplatz 1,
70435 Stuttgart,
Germany

[74] WENPING PATENT & TRADE MARK AGENT LIMITED

1701 Tung Wai Commercial Building,
111 Gloucester Road,
Hong Kong



- [11] 2422945.8
[15] 13-03-2024
[30] 22-09-2023 / EU / 015034981-0001
[51] Cl. 9-07
[54] 瓶蓋
Lid for bottles
[73] Flashbay Electronics Hong Kong Ltd
Rm A, 26/F, Loong Wan Building,
8 North Point Road,
North Point, Hong Kong
[74] ACCOLADE IP LIMITED
10/F, Fu Fai Comm. Ctr.,
27 Hillier Street,
Sheung Wan, Hong Kong



-
- [11] 2422947.2M001
[15] 13-03-2024
[30] 17-10-2023 / EU / 015037293-0001
[51] Cl. 4-02
[54] 牙刷刷頭
Toothbrush head
[73] Koninklijke Philips N.V.
High Tech Campus 52,
5656 AG Eindhoven,
Netherlands
[74] ROUSE & CO. INTERNATIONAL (OVERSEAS) LIMITED
26/F., Tesbury Centre,
28 Queen's Road East,
Hong Kong



[11] 2422947.2M002

[15] 13-03-2024

[30] 17-10-2023 / EU / 015037293-0002

[51] Cl. 4-02

[54] 牙刷刷頭

Toothbrush head

[73] Koninklijke Philips N.V.

High Tech Campus 52,

5656 AG Eindhoven,

Netherlands

[74] ROUSE & CO. INTERNATIONAL (OVERSEAS) LIMITED

26/F., Tesbury Centre,

28 Queen's Road East,

Hong Kong



- [11] 2422947.2M003
[15] 13-03-2024
[30] 17-10-2023 / EU / 015037293-0003
[51] Cl. 4-02
[54] 牙刷刷頭
Toothbrush head
[73] Koninklijke Philips N.V.
High Tech Campus 52,
5656 AG Eindhoven,
Netherlands
[74] ROUSE & CO. INTERNATIONAL (OVERSEAS) LIMITED
26/F., Tesbury Centre,
28 Queen's Road East,
Hong Kong



-
- [11] 2422947.2M004
[15] 13-03-2024
[30] 17-10-2023 / EU / 015037293-0004
[51] Cl. 4-02
[54] 牙刷刷頭
Toothbrush head
[73] Koninklijke Philips N.V.
High Tech Campus 52,
5656 AG Eindhoven,
Netherlands
[74] ROUSE & CO. INTERNATIONAL (OVERSEAS) LIMITED
26/F., Tesbury Centre,
28 Queen's Road East,
Hong Kong



[11] 2422947.2M005

[15] 13-03-2024

[30] 17-10-2023 / EU / 015037293-0005

[51] Cl. 4-02

[54] 牙刷刷頭

Toothbrush head

[73] Koninklijke Philips N.V.

High Tech Campus 52,

5656 AG Eindhoven,

Netherlands

[74] ROUSE & CO. INTERNATIONAL (OVERSEAS) LIMITED

26/F., Tesbury Centre,

28 Queen's Road East,

Hong Kong



- [11] 2422984.9
[15] 20-03-2024
[51] Cl. 23-04
[54] 空調扇
Air cooler
[73] 深圳市联创电器实业有限公司
中國深圳市龙岗区
南湾街道布澜路 21 号
联创科技园南区平顶房 1 栋 2 栋
[74] 栢珍妮策劃有限公司
香港上環
德輔道中 199 號
無限極廣場 12 樓



-
- [11] 2422991.4M001
[15] 21-03-2024
[30] 25-09-2023 / GB / 6315091
[51] Cl. 8-07
[54] 斜邊金屬扣
Metal clasp with bevelled edge
[73] Phoebe Philo Limited
2nd Floor, Gadd House,
Arcadia Avenue,
London, N3 2JU, United Kingdom
[74] LEWIS SILKIN
Unit 1302, 13/F, Dina House, Ruttonjee Centre,
11 Duddell Street,
Central, Hong Kong

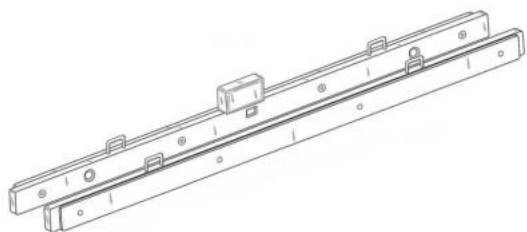

[11] 2422991.4M002

[15] 21-03-2024

[30] 25-09-2023 / GB / 6315092

[51] Cl. 8-07

[54] 金屬封閉扣

Metal closure clasp

[73] Phoebe Philo Limited

2nd Floor, Gadd House,

Arcadia Avenue,

London, N3 2JU, United Kingdom

[74] LEWIS SILKIN

Unit 1302, 13/F, Dina House, Ruttonjee Centre,

11 Duddell Street,

Central, Hong Kong

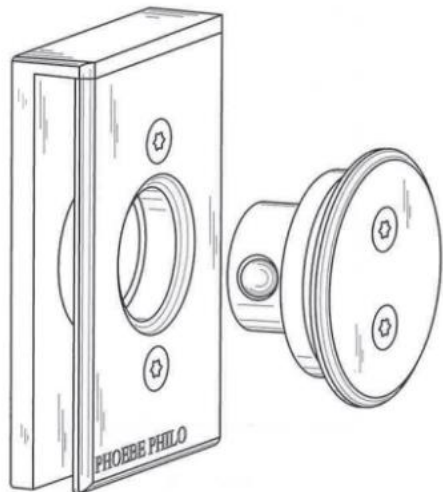

[11] 2423001.7

[15] 22-03-2024

[51] Cl. 11-01

[54] 吊咀

Pendant

[73] 蒂廷國際有限公司
香港九龍紅磡
民裕街 41 號
凱旋工商中心一期 1 樓 A3 室

[74] 蒂廷國際有限公司
香港九龍紅磡
民裕街 41 號
凱旋工商中心一萬 1 樓 A3 室



[11] 2423031.0

[15] 26-03-2024

[30] 27-09-2023 / CN / 2023306344718

[51] C1. 21-01

[54] 玩具 (機器人)
Toy (robot)

[73] 汕頭市兒超喜智能科技實業有限公司
中國廣東省
汕頭市澄海區
廣益街道登峰路廣峰工業區 3 號

[74] 聚一知識產權有限公司
香港九龍尖沙咀
嘉蘭圍 5-11 號
利時商業大廈 1813 號

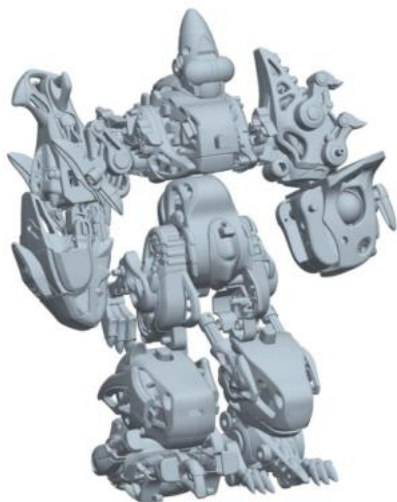

[11] 2423036.1

[15] 26-03-2024

[30] 27-09-2023 / CN / 2023306345231

[51] C1. 21-01

[54] 玩具 (機器人造型)
Toy (robot shape)

[73] 汕頭市兒超喜智能科技實業有限公司
中國廣東省
汕頭市澄海區
廣益街道登峰路廣峰工業區 3 號

[74] 聚一知識產權有限公司
香港九龍尖沙咀
嘉蘭圍 5-11 號
利時商業大廈 1813 號



[11] 2423049.8M001

[15] 27-03-2024

[30] 10-10-2023 / MC, CN, RU, SG, CH, GB, US, EU, JP, KR /
WIPO139411

[51] Cl. 26-05

[54] 照明設備

Lighting unit

[73] COMPAGNIE DES CRISTALLERIES DE SAINT-LOUIS Société par actions
simplifiée

F-57620,

Saint-Louis les Bitche,

France

[74] DEACONS

5th Floor, Alexandra House,

Central,

Hong Kong

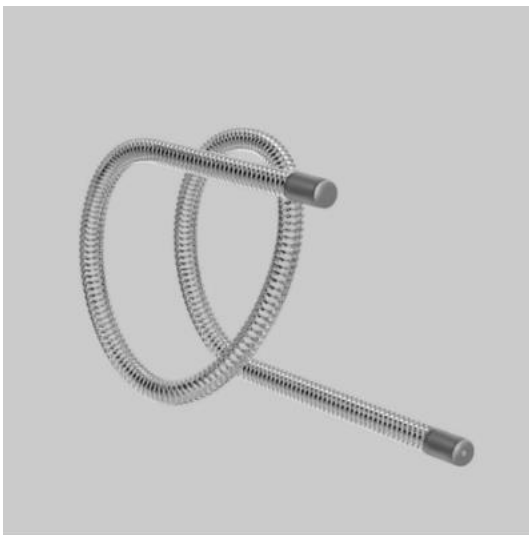

[11] 2423049.8M002

[15] 27-03-2024

[30] 10-10-2023 / MC, CN, RU, SG, CH, GB, US, EU, JP, KR /
WIPO139419

[51] Cl. 26-05

[54] 吊燈

Chandelier

[73] COMPAGNIE DES CRISTALLERIES DE SAINT-LOUIS Société par actions
simplifiée

F-57620,

Saint-Louis les Bitche,

France

[74] DEACONS
5th Floor, Alexandra House,
Central,
Hong Kong

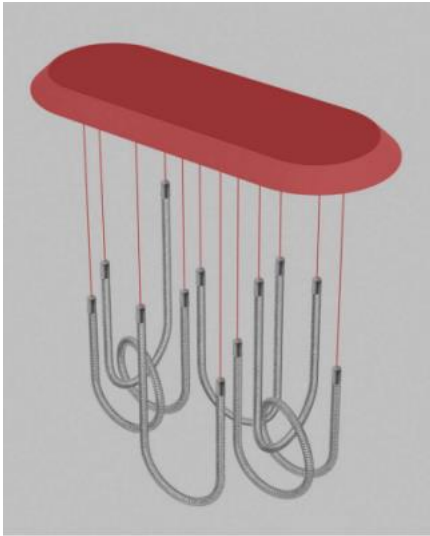

[11] 2423049.8M003

[15] 27-03-2024

[30] 10-10-2023 / MC, CN, RU, SG, CH, GB, US, EU, JP, KR /
WIPO139432

[51] Cl. 26-05

[54] 吊燈
Chandelier

[73] COMPAGNIE DES CRISTALLERIES DE SAINT-LOUIS Société par actions
simplifiée
F-57620,
Saint-Louis les Bitche,
France

[74] DEACONS
5th Floor, Alexandra House,
Central,
Hong Kong



[11] 2423101.9

[15] 09-04-2024

[30] 16-11-2023 / KR / 30-2023-0045529

[51] Cl. 28-03

[54] 皮膚護理器

Skin treatment apparatus

[73] LG Jeon za Joo-sik-hoi-sa (LG Electronics Inc.)

128, Yeoui-daero,

Yeongdeungpo-gu, Seoul, 07336,

Republic of Korea

[74] SPRUSON & FERGUSON (HONG KONG) LIMITED

5001 Hopewell Centre,

183 Queen's Road East, Wan Chai,

Hong Kong

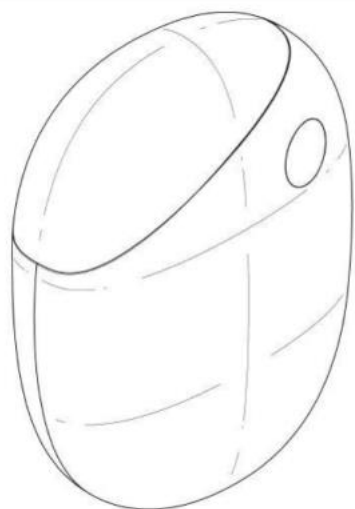

- [11] 2423139.9
[15] 16-04-2024
[30] 18-10-2023 / US / 29/914,446
[51] Cl. 22-01
[54] 槍枝包裝盒用組織格柵
Organizing grid for storage case
[73] Magpul Industries Corp.
5408 US Highway 290 West, Austin, TX 78735,
United States of America
[74] TRADEMARKCN COMPANY LIMITED
Block A, 4/F., Granville Building,
14 Granville Road, Tsim Sha Tsui, Kowloon,
Hong Kong

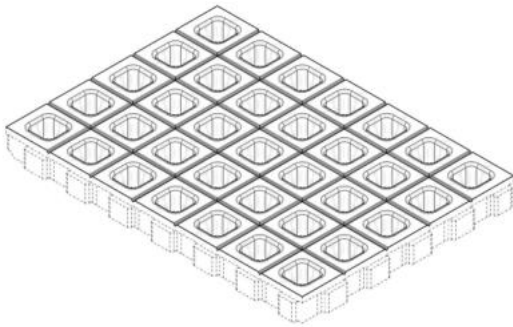

-
- [11] 2423162.7
[15] 18-04-2024
[51] Cl. 9-05
[54] 牙膏紙袋
Paper bag for toothpaste
[73] 明輝實業國際有限公司
Ming Fai Enterprise International Co.,Ltd
香港
新界荃灣海盛路3號
TML 廣場8樓D3室
[74] 緯能顧問有限公司
香港
中環皇后大道中41至47號
聯成大廈2樓204室



[11] 2423167.8M001

[15] 18-04-2024

[30] 20-10-2023 / CN / 2023306811594

[51] Cl. 24-01

Cl. 24-02

[54] 骨科手術導航定位系統導航台車

Navigation trolley for orthopedic surgery navigation and positioning system

[73] 鑫君特(蘇州)醫療科技有限公司

中國

江蘇省蘇州市高新區富春江路 188 號

3 號樓 301、302、303 室

[74] 金諾知識產權公司

香港

九龍旺角花園街 45-47 號

仁康大廈 5 樓 B 室



- [11] 2423167.8M002
- [15] 18-04-2024
- [30] 20-10-2023 / CN / 2023306811594
- [51] C1. 24-01
C1. 24-02
- [54] 骨科手術導航定位系統導航台車
Navigation trolley for orthopedic surgery navigation and positioning system
- [73] 鑫君特(蘇州)醫療科技有限公司
中國
江蘇省蘇州市高新區富春江路 188 號
3 號樓 301、302、303 室
- [74] 金諾知識產權公司
香港
九龍旺角花園街 45-47 號
仁康大廈 5 樓 B 室



-
- [11] 2423171.6
- [15] 19-04-2024
- [30] 15-01-2024 / JP / 2024-000516
- [51] C1. 21-01
- [54] 抓握玩具
Grasping toy
- [73] 株式會社萬代
BANDAI CO., LTD.
4-8, Komagata 1-chome, Taito-ku, Tokyo,
Japan
- [74] 范紀羅江律師行
香港

灣仔港灣道 6-8 號

瑞安中心 23 樓

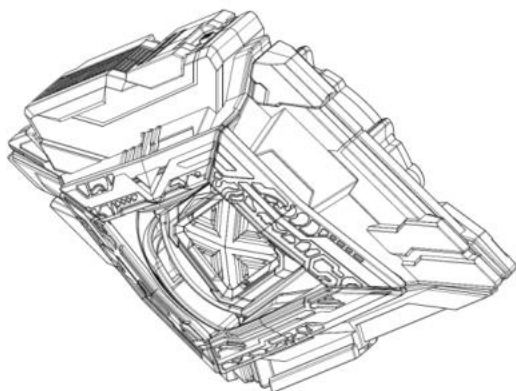

[11] 2423205.0

[15] 24-04-2024

[51] Cl. 11-01

[54] 吊咀
Pendant

[73] 蒂廷國際有限公司
香港
九龍紅磡民裕街 41 號
凱旋工商中心 1 期 1 樓 A3 室

[74] 蒂廷國際有限公司
香港
九龍紅磡民裕街 41 號
凱旋工商中心 1 期 1 樓 A3 室



[11] 2423206.2

[15] 24-04-2024

[51] Cl. 11-01

[54] 吊咀
Pendant

[73] 蒂廷國際有限公司
香港
九龍紅磡民裕街 41 號
凱旋工商中心 1 期 1 樓 A3 室

[74] 蒂廷國際有限公司
香港
九龍紅磡民裕街 41 號
凱旋工商中心 1 期 1 樓 A3 室



[11] 2423207.4

[15] 24-04-2024

[51] Cl. 11-01

[54] 吊咀
Pendant

[73] 蒂廷國際有限公司
香港
九龍紅磡民裕街 41 號
凱旋工商中心 1 期 1 樓 A3 室

[74] 蒂廷國際有限公司
香港
九龍紅磡民裕街 41 號
凱旋工商中心 1 期 1 樓 A3 室



[11] 2423208.6

[15] 24-04-2024

[51] Cl. 11-01

[54] 吊咀
Pendant

[73] 蒂廷國際有限公司
香港
九龍紅磡民裕街 41 號
凱旋工商中心 1 期 1 樓 A3 室

[74] 蒂廷國際有限公司
香港
九龍紅磡民裕街 41 號
凱旋工商中心 1 期 1 樓 A3 室



[11] 2423209.8

[15] 24-04-2024

[51] Cl. 11-01

[54] 吊咀
Pendant

[73] 蒂廷國際有限公司
香港
九龍紅磡民裕街 41 號
凱旋工商中心 1 期 1 樓 A3 室

[74] 蒂廷國際有限公司
香港
九龍紅磡民裕街 41 號
凱旋工商中心 1 期 1 樓 A3 室



[11] 2423210.0

[15] 24-04-2024

[51] Cl. 11-01

[54] 吊咀
Pendant

[73] 蒂廷國際有限公司
香港
九龍紅磡民裕街 41 號
凱旋工商中心 1 期 1 樓 A3 室

[74] 蒂廷國際有限公司
香港
九龍紅磡民裕街 41 號
凱旋工商中心 1 期 1 樓 A3 室



[11] 2423211.2

[15] 24-04-2024

[51] Cl. 11-01

[54] 吊咀
Pendant

[73] 蒂廷國際有限公司
香港
九龍紅磡民裕街 41 號
凱旋工商中心 1 期 1 樓 A3 室

[74] 蒂廷國際有限公司
香港
九龍紅磡民裕街 41 號
凱旋工商中心 1 期 1 樓 A3 室



[11] 2423212.4

[15] 24-04-2024

[51] Cl. 11-01

[54] 吊咀
Pendant

[73] 蒂廷國際有限公司
香港
九龍紅磡民裕街 41 號
凱旋工商中心 1 期 1 樓 A3 室

[74] 蒂廷國際有限公司
香港
九龍紅磡民裕街 41 號
凱旋工商中心 1 期 1 樓 A3 室



[11] 2423213.6

[15] 24-04-2024

[51] Cl. 11-01

[54] 吊咀
Pendant

[73] 蒂廷國際有限公司
香港
九龍紅磡民裕街 41 號
凱旋工商中心 1 期 1 樓 A3 室

[74] 蒂廷國際有限公司
香港
九龍紅磡民裕街 41 號
凱旋工商中心 1 期 1 樓 A3 室



[11] 2423226.4

[15] 25-04-2024

[51] Cl. 7-04

[54] 食物切碎裝置
Food cutting device

[73] 汪恩光
WONG YAN KWONG
Unit 403-404, 4/F., Po Lung Centre,
11 Wang Chiu Road, Kowloon Bay, Kowloon,
Hong Kong

[74] LEUNG KI HIN & CO.
7/F, Hang Seng Yuen Long Building,
91-93 Castle Peak Road, Yuen Long,
Hong Kong



- [11] 2423230.2
[15] 26-04-2024
[30] 16-11-2023 / EU / 015041164-0001
[51] Cl. 3-01
[54] 手提包
Tote bag
[73] RIMOWA GmbH
Richard-Byrd-Str. 13,
50829 Cologne,
Germany
[74] ROBIN BRIDGE & JOHN LIU
6th Floor, Emperor Commercial Centre,
39 Des Voeux Road Central,
Hong Kong

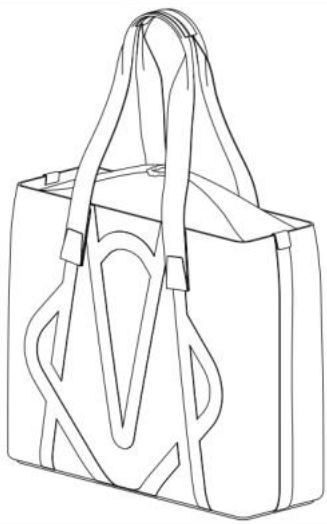

-
- [11] 2423233.8
[15] 26-04-2024
[30] 31-10-2023 / SG / 30202301250W
[51] Cl. 3-01
[54] 行李箱
Luggage
[73] 新秀麗 IP 控股有限責任公司
Samsonite IP Holdings S.à r.l.
13-15 avenue de la Liberté,
L-1931 Luxembourg,
Luxembourg
[74] WILKINSON & GRIST
6th Floor, Prince's Building,
Chater Road, Central,
Hong Kong

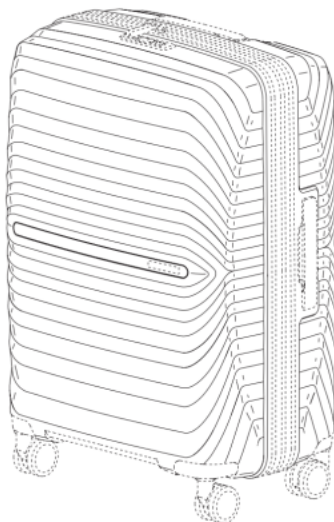

[11] 2423234.0

[15] 26-04-2024

[30] 30-10-2023 / SG / 30202301240U

[51] Cl. 3-01

[54] 行李箱

Luggage

[73] 新秀麗 IP 控股有限責任公司

Samsonite IP Holdings S.à r.l.

13-15 avenue de la Liberté,

L-1931 Luxembourg,

Luxembourg

[74] WILKINSON & GRIST

6th Floor, Prince's Building,

Chater Road, Central,

Hong Kong



[11] 2423241.5

[15] 29-04-2024

[51] Cl. 24-02

[54] 吸奶器

Breast pump

[73] 黎海英

LI HaiYing

中國

广西贺州市八步区建设中路 65 号

[74] HONG KONG DECENT INTELLECTUAL PROPERTY AGENT LIMITED

香港

文咸東街 78 號

華東商業大廈三樓



[11] 2423242.7M001

[15] 29-04-2024

[30] 02-11-2023 / EU / 015039247-0001

[51] Cl. 7-02

[54] 奶泡器

Milk frother

[73] VERSUNI HOLDING B.V.

HIGH TECH CAMPUS 42, 5656AE EINDHOVEN,

NETHERLANDS

[74] CHANG TSI AND PARTNERS INTELLECTUAL PROPERTY (HK) LIMITED

Level 20, One International Finance Centre,

No. 1 Harbour View Street, Central,

Hong Kong

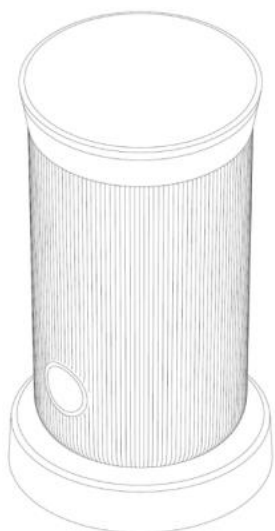

[11] 2423242.7M002

[15] 29-04-2024

[30] 02-11-2023 / EU / 015039247-0002

[51] Cl. 7-02

[54] 奶泡器

Milk frother

[73] VERSUNI HOLDING B.V.

HIGH TECH CAMPUS 42, 5656AE EINDHOVEN,
NETHERLANDS

[74] CHANG TSI AND PARTNERS INTELLECTUAL PROPERTY (HK) LIMITED

Level 20, One International Finance Centre,
No. 1 Harbour View Street, Central,
Hong Kong



- [11] 2423246.6
[15] 16-04-2024
[30] 18-10-2023 / US / 29/914,446
[51] Cl. 22-01
[54] 槍枝包裝盒用組織格柵
Organizing grid for storage case
[73] Magpul Industries Corp.
5408 US Highway 290 West, Austin, TX 78735,
United States of America
[74] TRADEMARKCN COMPANY LIMITED
Block A, 4/F., Granville Building,
14 Granville Road, Tsim Sha Tsui, Kowloon,
Hong Kong

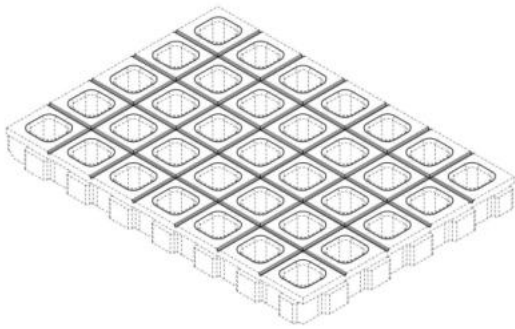

-
- [11] 2423264.3
[15] 03-05-2024
[51] Cl. 15-09
[54] 彎曲及剪鋼筋機
Steel bars bending cutting machine
[73] 黃博華以合成機器廠之名營業
WONG, Pok Wa trading as HOP SHING MACHINERY FTY
香港
新界元朗洪水橋
田廈路新李屋村 106 號
[74] 栢珍妮策劃有限公司
香港
上環德輔道中 199 號
無限極廣場 12 樓



[11] 2423265.6

[15] 03-05-2024

[51] Cl. 15-09

[54] 自動彎曲鋼筋機

Automatic steel bending machine

[73] 黃博華以合成機器廠之名營業

WONG, Pok Wa trading as HOP SHING MACHINERY FTY

香港

新界元朗洪水橋

田廈路新李屋村 106 號

[74] 栢珍妮策劃有限公司

香港

上環德輔道中 199 號

無限極廣場 12 樓



[11] 2423266.8

[15] 03-05-2024

[51] Cl. 15-09

[54] 自動彎曲及剪鋼筋機

Automatic steel bending cutting machine

[73] 黃博華以合成機器廠之名營業

WONG, Pok Wa trading as HOP SHING MACHINERY FTY

香港

新界元朗洪水橋

田廈路新李屋村 106 號

[74] 栢珍妮策劃有限公司

香港

上環德輔道中 199 號

無限極廣場 12 樓





香港特別行政區政府知識產權署外觀設計註冊處

The Government of the Hong Kong Special Administrative Region

Designs Registry, Intellectual Property Department

根據註冊外觀設計條例第 28 條，下列註冊外觀設計因未繳續期費而停止有效。

各組記項按註冊外觀設計停止有效日期及註冊編號先後次序排列。

Registered designs ceased through non-payment of renewal fees under section 28 of the Registered Designs Ordinance. Entries are listed below under their expiry dates.

02-05-2024 - 08-05-2024

| | | |
|-------------------|-------------------|-------------------|
| 02-05-2024 | 0900711.7 | 0410997.9M003 |
| 1913575.5 | 0900717.0 | 0411001.9 |
| 1913576.7M001 | 1400837.1 | 0900739.6 |
| 1913576.7M002 | 1400838.3 | 1400852.2 |
| 1913576.7M003 | | 1400863.5 |
| 1913577.9M001 | 05-05-2024 | 1913594.4 |
| 1913577.9M002 | 0900725.7M001 | 1913596.9 |
| 1913577.9M003 | 0900725.7M002 | 1913597.1 |
| 1913577.9M004 | 0900726.9M001 | 1913598.3 |
| 1913578.1M001 | 0900726.9M002 | 1913600.9 |
| 1913578.1M002 | 0900726.9M003 | 1913601.1 |
| 1913578.1M003 | 0900726.9M004 | 1913603.5 |
| 1913578.1M004 | 1913584.3M001 | 1913604.7 |
| 1913578.1M005 | 1913584.3M002 | 1913605.0 |
| 1913578.1M006 | 1913584.3M003 | |
| 1913578.1M007 | 1913587.0 | 08-05-2024 |
| 1913578.1M008 | | 1400865.0 |
| 1913578.1M009 | 06-05-2024 | 1400873.6 |
| 1913578.1M010 | 0410988.0M001 | 1913606.2M001 |
| 1913578.1M011 | 0410988.0M004 | 1913606.2M002 |
| 1913579.3M001 | 0410988.0M005 | 1913606.2M003 |
| 1913579.3M002 | 1400842.1M001 | 1913606.2M004 |
| 1913579.3M003 | 1400842.1M002 | 1913606.2M005 |
| 1913579.3M004 | 1400842.1M003 | 1913607.4 |
| 1913580.5M001 | 1400842.1M004 | 1913609.8 |
| 1913580.5M002 | 1400842.1M005 | |
| 1913580.5M003 | 1400843.3M001 | |
| 1913580.5M004 | 1400843.3M002 | |
| 1913580.5M005 | 1400848.4M003 | |
| 1913580.5M006 | 1913590.6 | |
| 1913582.9M002 | 1913591.8M001 | |
| 1913582.9M003 | 1913591.8M002 | |

04-05-2024

07-05-2024



香港特別行政區政府知識產權署外觀設計註冊處

The Government of the Hong Kong Special Administrative Region

Designs Registry, Intellectual Property Department

根據註冊外觀設計規則第 31 條刪除的註冊外觀設計。各組記項按註冊外觀設計刪除日期及註冊編號先後次序排列。

Registered designs removed under section 31 of the Registered Designs Rules. Entries are listed below under their removal dates.

11-05-2024 - 16-05-2024**11-05-2024**

0802638.3

1802192.7

1802193.9

1802197.8M001

13-05-2024

0802670.0

1802197.8M002

1802198.0

0802673.6

0802674.8

15-05-2024

0802677.5M001

1301979.1

0802677.5M002

1301983.9M001

0900734.5M001

1301983.9M002

0900734.5M002

1802203.2

0900734.5M003

1802204.4

0900734.5M004

0900734.5M007

16-05-2024

0900734.5M008

1301985.4

0900734.5M009

1802205.7M001

0900734.5M010

1802205.7M002

1301965.2M001

1802205.7M003

1301965.2M002

1802205.7M004

1301967.6

1802205.7M005

1301968.8

1802205.7M006

1301969.0

1802205.7M007

1301970.2

1802205.7M008

1802177.6

1802205.7M009

1802181.4

1802205.7M010

1802186.5

1802205.7M011

1802187.7

1802205.7M012

1802188.9

1802209.5

1802189.1

14-05-2024

0311907.0

0311908.2

0802680.1



香港特別行政區政府知識產權署外觀設計註冊處

The Government of the Hong Kong Special Administrative Region

Designs Registry, Intellectual Property Department

根據註冊外觀設計條例第 76 條，更正已提交文件中的錯誤

Correction of errors in filed documents under section 76 of the Registered Designs Ordinance

下列在 22.03.2024 官方公報刊登的更正錯誤的請求已在 23.05.2024 獲准許

The following request for correction of error advertised in the official journal on 22.03.2024 was allowed on 23.05.2024

[21] 2422857.1

[30] 29-08-2023 / JP / 017448 of 2023



香港特別行政區政府知識產權署外觀設計註冊處

The Government of the Hong Kong Special Administrative Region

Designs Registry, Intellectual Property Department

根據註冊外觀設計條例第 76 條，更正已提交文件中的錯誤

Correction of errors in filed documents under section 76 of the Registered Designs Ordinance

任何人士現可對下列更正錯誤的請求提出反對

Request for correction of errors now open to opposition

如任何人士意欲反對下列請求，則須在本官方公報刊登是項更正請求的日期起計的兩個月內，根據註冊外觀設計規則第 62(4) 條，採用指明外觀設計表格第 D9 號提交反對通知。如在限期內沒有收到任何反對通知，處長將依本公報刊登的更正請求的內容，准許是項更正請求。

If any person wishes to oppose the following request, he shall file a notice of opposition in specified Designs Form D9 within two months from the date of advertisement in this official journal under section 62(4) of the Registered Designs Rules. If no notice of opposition is received, the request for correction will be allowed by the Registrar in the present advertised form.

請求更正表述的錯誤

Request made for correction of errors in representations

[21] 2422770.6M001

[55] Representations of the design

[21] 2422770.6M002

[55] Representations of the design

[21] 2422770.6M003

[55] Representations of the design

[21] 2422770.6M004

[55] Representations of the design

[21] 2422770.6M005

[55] Representations of the design

[21] 2422770.6M006

[55] Representations of the design

[21] 2422770.6M007

[55] Representations of the design

[21] 2422770.6M008

[55] Representations of the design